



UNIFAP.com.br

Porta-escovas
Brush Holders

Polias
Pulleys

Garfos
Engaging Levers

Planetárias
Planetary Gears

**Articulação de Acionamento para
Limpadores de Parabrisa**
Window Wiper Linkage Transmission

Buchas Sinterizadas
Sintered Bushes

2016/17 Peças Automotivas
Automotive Parts





- Polias para alternador e dínamo;
- Articulação de acionamento para limpador de parabrisas;
- Buchas Sinterizadas;

Comprovando a preocupação da marca UNIFAP em oferecer produtos de excelente qualidade, a mesma já é encontrada em 18 países (Estados Unidos, Canadá, México, França, Portugal, Egito, Turquia, Emirados Árabes, Guatemala, Venezuela, Colômbia, Equador, Peru, Bolívia, Paraguai, Chile, Argentina e Uruguai). A empresa mantém-se atualizada com as inovações e exigências, tanto do mercado interno quanto externo, através da participação em exposições e feiras no ramo de autopeças no Brasil e no exterior.

Segura de seus objetivos, a UNIFAP investe constantemente em projetos, ferramentaria, implantação da certificação de qualidade ISO, automação e máquina, visando atender cada vez melhor seus clientes.

Por tudo isso, a UNIFAP é hoje uma empresa sólida, baseada em anos de experiência em sua área, que transmite segurança a todos os seus clientes, fornecedores e colaboradores.

Fundada em 01 de abril de 1992, pelos irmãos Ivo e Nelson Bittencourt, a UNIFAP INDÚSTRIA METALÚRGICA LTDA deu início às suas atividades com o objetivo de atuar no ramo de peças automotivas, tendo como princípio fabricar produtos de alta qualidade, a preços justos.

Fiel a este princípio, a empresa cresce ano a ano, e conta hoje com instalações de 6.200 m² de área construída, numa área total disponível de 335.000 m². Localizada ao sul do país, na cidade de Gaspar, estado de Santa Catarina, a empresa tem uma das maiores linhas do segmento, o que a coloca entre as principais do setor no país, sendo os principais produtos:

- Porta escovas para motores de partida;
- Porta escovas para alternadores;
- Porta escovas para limpadores de pára-brisa;
- Planetárias para motores de partida;
- Garfos para motores de partida;





UNIFAP INDÚSTRIA METALÚRGICA LTDA was founded on April 01, 1992 by the brothers Ivo and Nelson Bittencourt, with the purpose of manufacturing automotive electrical parts.

Aiming at producing high quality products with fair prices the company has been growing on a yearly basis, settled in 6.200 sq. meter-plant, in a total area of 335.000 sq. meters.

The company is located in Gaspar, province of Santa Catarina, in the south of Brazil. Today it has one of the largest lines, placing UNIFAP among the top manufactures of the sector, being the main products:

- Brush holder for starter, alternators and othe;
- Planetary gears;
- Engaging levers for starter motors;
- Pulleys for alternator and dynamo;



- Window wiper linkage transmission;
- Sintered Bushes;

UNIFAP parts can now be found in 18 countries (United States, Canada, Mexico, France, Portugal, Egypt, Turkey, United Emirates, Guatemala, Venezuela, Colombia, Equator, Peru, Bolivia, Paraguay, Chile, Argentina and Uruguay).

The company keeps updated with the market demands, taking part in the most, important international fairs, and constantly investing in projects, tooling, quality certification and technology, always diligent in assisting customers effectively. All these has made UNIFAP a solid company, based on years of experience, providing guaranted satisfaction to both customers and suppliers.



Bosch

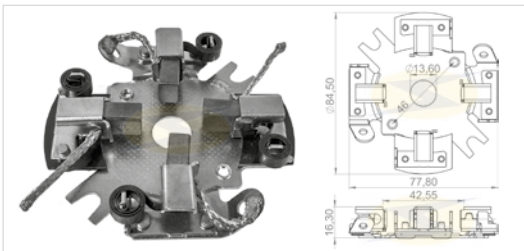

UF - 1.101

UF - 1.101/2 2 escovas / brushes

UF - 1.101/4 4 escovas / brushes

Especificações / Features: 12V, Tipo / Type: EF - Escova / Brush: 7 x 10 x 18 mm

(L x A x C / W x H x L)

Original: 9 001 082 518, 9 001 082 239

Partida / Starter: 9 000 082 028, 9 000 082 033, 9 000 082 042, 9 000 082 045, 9 000 082 046, 9 000 082 049, 9 000 082 051, 9 000 082 053, 9 000 082 054, 9 000 082 059, 9 000 082 061, 9 000 082 064, 9 000 082 066, 9 000 082 069, 9 000 082 070, 9 000 082 073, 9 000 082 074, 9 000 082 078, 9 000 082 079, 9 000 082 082, 9 000 082 083, 0 001 211 219, 9 000 AL0 301, F 000 AL0 306, F 000 AL0 329

Aplicação / Application: **AGRALE-DEUTZ:** 4100, M70 / 80 / 85 / 90 / 93ID, TX1100, **CHEVROLET-GM:** CHEVETTE, HATCH, CHEVY 500, MARAJÓ, FIAT: PREMIO / RALLY / SPAZIO, DUNA 60 / 70 / WEEKEND, UNO 1.1 / MILLE / ELX / EP, 147 FIORINO 1.5, ELBA 1.5, PRÊMIO 1.5, UNO 1.5 / 1.6, 147 / 147 CITY / EUROPA / FIORINO / GLS / OGGI / PANORAMA / PICK-UP / ELBA 1.5, TEMpra 2.0 MPI / SPI 16V / 8V,

TEMpra 2.0 TURBO, TIPO 1.6 I.E., UNO 1.6 MPI, **FORD:** BELLINA 1.8, DEL REY 1.8, PAMPA 1.8, ROYALE 1.8 / 2.0, VERSAILLES 1.8 / 2.0, **GURGEL:** BR 800, TOCANTINS L, TR, **VOLKSWAGEN:** SEDAN, SUPERMINI, KARMANN GHIA 1600, SP, 600 / 1700, VARIANT II 1600, BRASÍLIA 1.3/1.6, FUSCA 1300 / 1500 / 1600, 302, 307, 309, GOL 1.8, KOMBI 1.6, GOL 1.0, GOL II 1.0i, II / III / 1.6, SAVEIRO 1.6, VOYAGE 1.6, 1.6, VOYAGE 1.5 / 1.6, QUANTUM 2.0i, SANTANA 2.0i, **YANMAR:** BT22 / 23MICROTRATORES CT 11 / TC 11 SUPER, **LADA:** NIVA 1.5 / 1.6, **MOTORES TIETE:** 950 / 950 L

Bosch

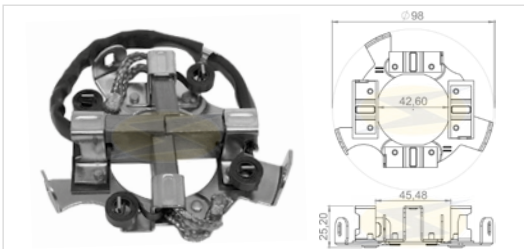

UF - 1.102

UF - 1.102/2 2 escovas / brushes

UF - 1.102/4 4 escovas / brushes

Especificações / Features: 12V, Tipo / Type: MPB - Escova / Brush: 8,8 x 19 x 22 mm

(L x A x C / W x H x L)

Original: 9 001 453 023, WAPSA: 246007

Partida / Starter: 9 000 453 020, 9 000 453 033, 9 000 453 034, 9 000 453 041, 9 000 453 044, 9 000 453 046, 9 000 453 047, 9 000 453 050, 9 000 453 053, 9 000 453 054, 9 000 453 060, 9 000 453 061

Aplicação / Application: **CHEVROLET-GM:** A60 / A70 / A80 / A90, CAMINHÕES C/ PERKINS 4 CIL./6 CIL., **FORD:** CARGO WORLD TRUCK 1113, F 1000 / 2000 / 4000 / 7000 / 11000 / 12000 / 13000 / 19000 / 21000 / 22000, TRATORES 4600 / 5600 / 6600, F 4000, F 11000 / 12000 / 13000, **VOLKSWAGEN:** SÉRIE 7T-7.90S / 7.110S, SÉRIE 12T - 12.140H, SÉRIE 7T-7.140 / 11T-11.160 / 12T-22.160, **FIAT-ALLIS:** FB 80.2, **NEW HOLLAND:** 4630 / 5030 / 5630 / 6630 / 7630 / 7830 / 8030, **CASE:** TRATOR ESCAVO CARREGADOR W7 C/ PERKINS 6 CIL., TRATOR

RETRO-ESCAVADOR 580E / 580CK, **CBT:** TRATORES 1090 / 1100 C/ PERKINS 6 CIL., **CHRYSLER:** CAMINHÕES P-700 C/ PERKINS 6 CIL., **CLARK:** EMPILHADEIRA / **FORKLIFT** C300 HY 40 / 50 / 60, TRATORES MICHIGAN 75A II / III, **EATON:** EMPILHADEIRA/ **FORKLIFT** D83P / D83C / D87P, PÁ-CARREGADEIRA 250A / 1900, **HYSTER:** EMPILHADEIRA / **FORKLIFT** C/ PERKINS 4203 / 4236 4 CIL., **MASSEY-FERGUSON:** TRATORES 95 X / 95 L, MOTOR INDUSTRIAL - PERKINS, MF 295/4 / 296 / 296/4, MF 3000 / 3366 / MF-400, MF-200 / MF-296

Bosch

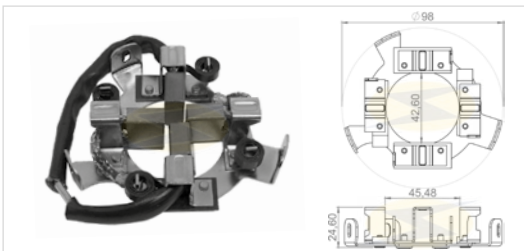

UF - 1.103

UF - 1.103/2 2 escovas / brushes

UF - 1.103/4 4 escovas / brushes

Especificações / Features: 12V, Tipo / Type: MPB - Escova / Brush: 8,8 x 19 x 18 mm

(L x A x C / W x H x L), Pólos invertidos / Inverted poles

Original: 9 001 453 024, WAPSA: 246005

Partida / Starter: 9 000 453 048, 9 000 453 013, WAPSA: 224030

Aplicação / Application: **AGRALE-DEUTZ:** 400 - 440 C/ MOTOR AGRALE M790, 4000 - 4200 C/ MOTOR AGRALE M790, **FORD:** MAVERICK V8 302

Bosch

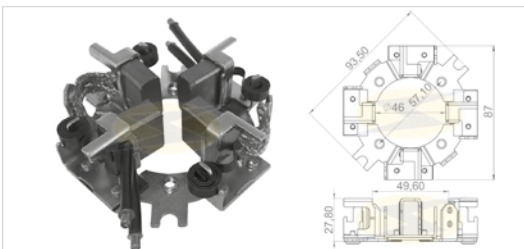

UF - 1.104

UF - 1.104/2 2 escovas / brushes

UF - 1.104/4 4 escovas / brushes

Especificações / Features: 12V, Tipo / Type: JF - Escova / Brush: 10 x 22 x 23,5 mm

(L x A x C / W x H x L)

Original: 9 001 083 392, 9 001 083 362

Partida / Starter: 9 000 083 053, 9 000 083 061, 9 000 083 055, 9 000 083 056, 9 000 083 058, 9 000 083 059

Aplicação / Application: **AGRALE-DEUTZ:** BX 4.60 / BX 60, 5000D / 6150 / 7000D / 7500TD / BX 100 / BX130, BX 4.90 / BX 4.100 / BX 4.110 / BX 4.130 / BX 4.150 / BX 90, **CASE:** W18 / W20 / W20B, **CBT:** 1065 / 1105 / 2080 / 2105 / 8060 4X4, **MERCEDES-BENZ:** L608D / 610 / L1013 / L1111 / 1113 / L1313 / 1313A / L1316 / 1316A / L1516 / L2013 / 2016 / L2213 / 2215 / 2216, O 362, **SLC:** 6200 / 6200 TURBO, 7200 TURBO / 7700 TURBO / W18 / W20 / W20B, OM 366 A / C / LA, SÉRIE 9T-917 / OF1113 / OH1112, SÉRIE 7000 - 7700 TURBO, **KOMATSU:** D90E / D50A, **CBT:** 2105, 8000 / 8240, **CHEVROLET-GM:** D20 / D20 PLUS / D6000, **MASSEY-FERGUSON:** MF-275 / 275-4 / 283 / 290 / 290-4 / 292,

MF 295 / 295/4, 296 / 296/4 Turbo, MF1630 / 3640 / 5650 / 6845 / 6855 / 6865, **CASE:** 80 CR / 80 P, **CBT:** 8260 4X4, 8000 - 8440, **FIAT-ALLIS:** FB 80, **MWM-DIESEL:** SÉRIE D / TD, **VALMET:** 65ID / 68 / 68 CAFEIRO / 68 ESPECIAL / 78S / 78 VE / 88 / 110ID / 118 / 118-4 / 128 / 128 4X4 / 138 TURBO / 138-4 TURBO / 148 4X4 / 148 TURBO / 880 / 880 4X4 / 980 4X4 TURBO, **JOHN DEERE:** JD 50 D, **MAXION:** IDEAL 9070 / 9075 / 9090, 9110 / 9130 / 9150 / 9170, **YANMAR:** BT / BTD / 1050.D / 1050.D 4X4

Bosch

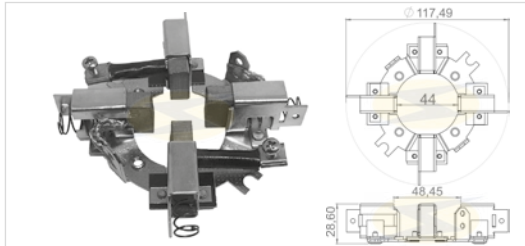

UF - 1.105

UF - 1.105/2 2 escovas / brushes

UF - 1.105/4 4 escovas / brushes

Especificações / Features: 12V, Tipo / Type: JF - Escova / Brush: 10 x 22 x 19 mm

(L x A x C / W x H x L)

Original: 9 001 083 569

Partida / Starter: 9 000 083 053, 9 000 083 054, 9 000 083 055, 9 000 083 056, 9 000 083 059, 9 000 083 061, 9 000 083 062, 9 000 083 069, 9 000 083 071, 9 000 083 072, 9 000 083 074, 9 000 083 075, 9 000 083 077, 9 000 453 072, 9 000 453 074, 9 000 453 076, 9 000 453 080, 9 000 453 082, 9 000 453 083, 9 000 453 089, 9 000 453 090, 9 000 453 091, F 006 AL0 602

Aplicação / Application: **AGRALE-DEUTZ:** BX 4.60 / BX 60, AX 4100 / 4190 / 100S / 120S / 80S, SÉRIES 5000 / 6000 / 7000 / BX, 1800 D / TX 1600, 7000 DX / TDX / 8500 TDX / MA 7.5 T, 6.150, **CASE:** W 18 / W20 / W20B, 80 CR / 80 P, W 20 E, 580H / SH 4X2, / 4X4, 580L, **CBT:** 1065 / 1105, 2080 / 2105, 8060 4X4, 8240, 8440, 8260 4X4, 2105, **PERKINS:** TRATORES, **MERCEDES-BENZ:** SÉRIES 61L / 7t / 7tL / 8tL /

9t / 10t / 11tL / 12t / 12tL / 13tL / 14tL / 15tL / 16tL / 17t / 20tL / 22tL / 23tL / 24t / O / OF / OH / OM, OM 366 A / C / LA, 917 / OF1113 / OH1113, MOTOR ESPECIAL DRESSER (À PROVA DE ÓLEO), **NEW HOLLAND:** 8040 / 8055, TC 55 / TC 57 / TC 59 / TM 120, TRATOR GAMALTA, **TOYOTA:** BANDEIRANTE OM 364 (01.91→12.01), **CHEVROLET-GM:** D20 / D 6000, **MASSEY-FERGUSON:** MF1630 / MF3640 / MF5650 / MF6845/55/65, MF295 / 295/4 / 296 / 296/4, MF235 / 265 / 296/5, **MAXION:** IDEAL 9075 / 9090, IDEAL 9070 / 9075 / 9110 / 9130 / 9150 / 9170, **FIAT-ALLIS:** FB 80, **MWM-DIESEL:** D 229-4 / D 229-5 / TD 229-6, D 229-3 / 229-4 / 229-6 / TBD / TD **SLC:** 7700 TURBO, **VALMET:** SÉRIES 62 / 65 / 68 / 78 / 88 / 110 / 118 / 128 / 138 / 148 / 880 / 980, 885S / 985S / 1180S / 1380S / 1680S / 1880S, 62 / 65 / 85 / 110 / 685, 1180, 785 / 885 / 985 / 1280 / 1580 / 1780, **MÜLLER:** VIBRO RT 62 / 82, TM 12 / 14, **JOHN DEERE:** JD 50 D, **KOMATSU:** D30E / D50A, RETRO ESCAVADEIRA DE ESTEIRAS, **YANMAR:** TRATOR 1050, BT / BTD / 1050.D / 1050.D 4X4, **FORD:** F 4000, CARGO WORLD TRUCK C, **PUMA:** 7900 / 7900 T, 914, **VOLKSWAGEN:** SÉRIES 7 t / 8 t / 9 t / 12 t / 13 t / 14 t / 15 t / 16 t / 17 t, 16.200 / 16.170 BT

Bosch

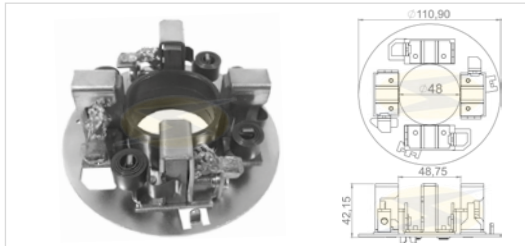

UF - 1.106

UF - 1.106/2 2 escovas / brushes

UF - 1.106/4 4 escovas / brushes

Especificações / Features: 12V, Tipo / Type: JE - Escova / Brush: 9 x 36 x 18 mm

(L x A x C / W x H x L)

Original: 9 001 453 640

Partida / Starter: 9 000 453 029, 9 000 453 067

Aplicação / Application: **CASE:** W 36 B TURBO, **CUMMINS:** CT - 6 CT-8.3, **KENWORTH:** 13.210 / 22.210, **PETERBILT:** 13.210 / 22.210 / 23.210, **VOLKSWAGEN:** 16 t - 16.210, **MERCEDES-BENZ:** 16 tL - L1625, 18 tL - LG1825, 23 tL - L / LB / LK2325

Bosch

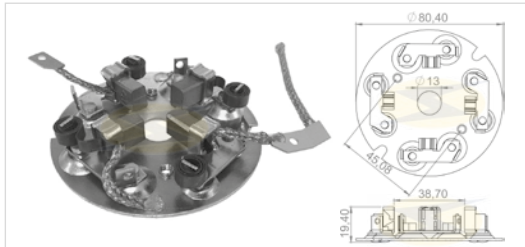

UF - 1.107

UF - 1.107/2 2 escovas / brushes

UF - 1.107/4 4 escovas / brushes

Especificações / Features: 12V, Tipo / Type: MWB - Escova / Brush: 7 x 10 x 17 mm

(L x A x C / W x H x L)

Original: 9 001 451 052, **WAPSA:** 246012

Partida / Starter: 9 000 451 017

Aplicação / Application: **FORD:** ESCORT - ÁLCOOL E TRANSMISSÃO AUTOMÁTICA / AUTOMATIC TRANSMISSION

Bosch

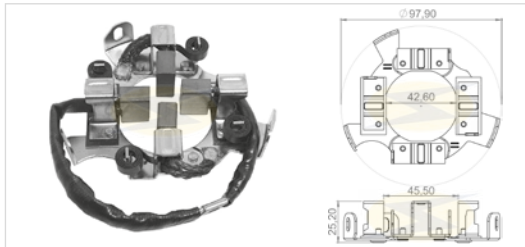

UF - 1.110/2 2 escovas / brushes

UF - 1.110/4 4 escovas / brushes

Especificações / Features: 12V, Tipo / Type: MPB - ESCOVA CURTA / SHORT BRUSH -

Escova / Brush: 8,8 x 19 x 13 mm (L x A x C / W x H x L)

Original: 9 001 453 025 (WAPSA)

Partida / Starter: 9 000 453 016, 9 000 453 038, 9 000 453 045, 9 000 453 049, 9 000 453 051, 9 000 453 052

Aplicação / Application: **CASE:** 580 - 580 H, **CBT:** TRATOR - 1000, **HYSTER:** EMPILHADEIRA / FORKLIFT COM MOTOR GM 2500 4 CIL. / GM 4100 6 CIL., **MASSEY-FERGUSON:** MF 200 - 283, MF 200 - 290, MF 5000 - 5300, COLHEITADEIRA / COMBINE 220, MF 200 - 275 / 285 / 290, TRATOR 85 X, TRATOR 65R

Bosch

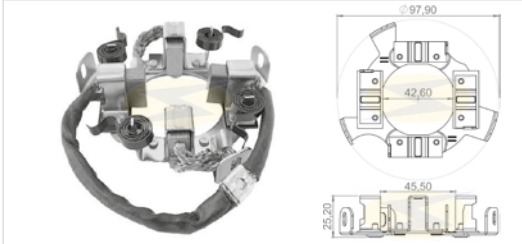

UF - 1.111/2 2 escovas / brushes
UF - 1.111/4 4 escovas / brushes

Especificações / Features: **12V, Tipo / Type: MPB** - Escova / Brush: 8,8 x 19 x 18 mm

(L x A x C / W x H x L)

Original: 9 001 453 023, **WAPSA:** 246007

Partida / Starter: 9 000 453 020, 9 000 453 033, 9 000 453 034, 9 000 453 041, 9 000 453 044, 9 000 453 046, 9 000 453 047, 9 000 453 050, 9 000 453 053, 9 000 453 054, 9 000 453 060, 9 000 453 061

Aplicação / Application: **CHEVROLET-GM:** A60 / A70 / A80 / A90, CAMINHÃO C / PERKINS 6 / 4 CIL., **FORD:** CARGO WORLD TRUCK 1113, F 2000 / 4000 / 7000 / 11000 / 12000 / 13000 / 19000 / 21000 / 22000, TRATOR 4600 / 5600 / 6600, **VOLKSWAGEN:** 7T - 7.90 S / 7.110 S, 12T - 12.140 H, 7.140 / 11.160 / 22.160, **CASE:** TRATOR ESCAVO CARREGADOR W7, TRATOR RETRO-ESCAVADOR 580E / 580 CK, **CBT:** TRATOR 1090 / 1100, **CHRYSLER:** CAMINHÃO P-700, **CLARK:** EMPILHadeira / **FORKLIFT** - C300 HY 40 / 50 / 60, TRATOR MICHIGAN 75A /

II / III, **EATON:** EMPILHadeira / **FORKLIFT** D83P / D83C / D78P, PÁ-CARREGADEIRA 250A / 1900, **FIAT-ALLIS:** FB 80.2, **FORD:** F 11000 / F 12000 / F 13000, F 4000, TRATOR 4600 / 5600 / 6600, **HYSTER:** EMPILHadeira / **FORKLIFT** COM MOTOR PERKINS 4203 / 4236 4 CIL., **MASSEY-FERGUSON:** MF 200 - MF 296, MF 295/4 / MF 296 / MF 296/4, MF 3000 - MF-3366 / MF-400, MOTOR INDUSTRIAL PERKINS, TRATOR 95X / 95L, **NEW HOLLAND:** 4630 / 5030 / 5630 / 6630 / 7630 / 7830 / 8030

Bosch

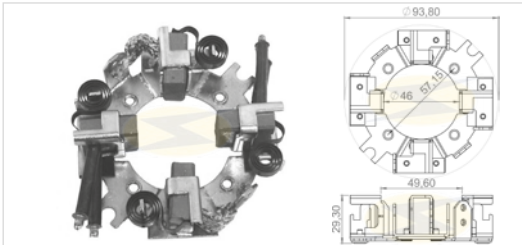

UF - 1.112/2 2 escovas / brushes
UF - 1.112/4 4 escovas / brushes

Especificações / Features: **24V, Tipo / Type: JF** - Escova / Brush: 10 x 22 x 23,5 mm

(L x A x C / W x H x L)

Original: 9 001 083 392

Partida / Starter: 9 000 083 043, 9 000 083 063, 9 000 083 064, 9 000 083 065, 9 000 083 066, 9 000 083 068, 9 000 083 073, 9 000 083 076, 9 000 453 075, 9 000 453 079, 9 000 453 086, 9 000 453 088

Aplicação / Application: **FIAT:** 80 / 80S / 120 / 130 / 140 / 8340 / 8360, CAMINHÕES: 80 / 120 / 140, **MERCEDES-BENZ:** 13 t L - L 1317, - 15 t L - L 1517, **FIAT-ALLIS:** AD - AD 7 B (06/1985→), AD - AD 7 B (12/1984→), DEMAIS ÔNIBUS E CAMINHÕES C / PARTIDA JF 24V

Bosch

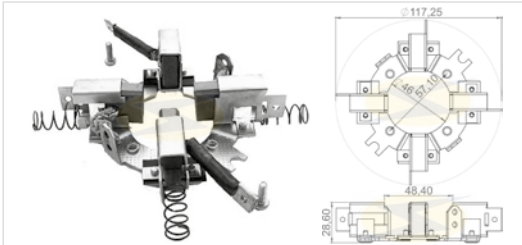

UF - 1.113/2 2 escovas / brushes
UF - 1.113/4 4 escovas / brushes

Especificações / Features: **24V, Tipo / Type: JF** - Escova / Brush: 10 x 22 x 19 mm

(L x A x C / W x H x L)

Original: 9 001 083 596

Partida / Starter: 9 000 083 043, 9 000 083 054, 9 000 083 063, 9 000 083 064, 9 000 083 065, 9 000 083 066, 9 000 083 068, 9 000 083 073, 9 000 083 076, 9 000 453 075, 9 000 453 079, 9 000 453 086, 9 000 453 088, F 000 AL0 700

Aplicação / Application: **FIAT:** 80 / 80S / 120 / 130 / 140 / 8340 / 8360, **YANMAR:** MOTOR ESTACIONÁRIO E MARÍTIMO, **CASE:** W18 D / W 18 E / W 20 D / W20 E, **EL DETALLE:** OA 101 - (09/1997→), **MERCEDES-BENZ:** 12 T L - L 1214 / 1217 / 1218, 14 T L - L 1414 / 1418, 16 T L - L 1614 / 1618 / 1621, OF 1318 / 1620, 13 T L - L 1317 / 15 T L - L 1517, O 371 U / UL, OF 1115 / 1315 / 1721, OH 1315 G / OH 1318 / OH 1621 LG / OH 1623 LG, **FIAT-ALLIS:** FG 140 - MOTOR 6 CT 8.3 - (02/1999→), AD 7 B, FA 120, FH 200, FD 9, FR 10 B, FR 12 B, FR 120.2,

VOLVO: VME L 30, **CASE:** 888 BCKE, 888 CKE, **KOMATSU:** A 835; GD 523 A, GD 523 R, PC 150 SE, RETRO-ESCAVADEIRA PC 150 MODELO 3, **FORD:** CARGO WORLD TRUCK 1618, B 1618, B 1621, **IVECO:** 120 E15, 150, 149 E 18, 150 E 20, 150 E 20 T, 150 T, 160 E 21, 160 E 23, 160 E 23 T, **VOLKSWAGEN:** 16 T - 16.180 CO / 16.210 CO, 17T - 17.210 OD / 17.240OT, B 16.180, L 80

Bosch

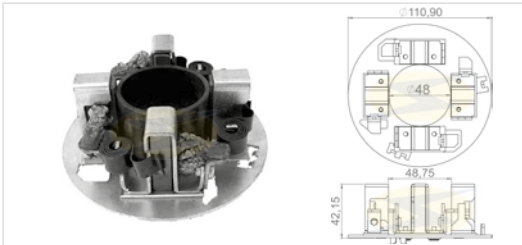

UF - 1.114/2 2 escovas / brushes
UF - 1.114/4 4 escovas / brushes

Especificações / Features: **24V, Tipo / Type: JE** - Escova / Brush: 9 x 36 x 18 mm

(L x A x C / W x H x L)

Original: 9 001 453 625

Partida / Starter: 9 000 453 068, F 000 AL0 801

Aplicação / Application: **DECAROLI, MERCEDES-BENZ, DEMAIS ÔNIBUS E CAMINHÕES COM PARTIDA JE 24V**

Bosch

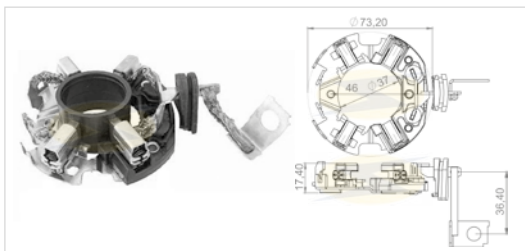

UF - 1.115/4 4 escovas / brushes

Especificações / Features: 12V, Tipo / Type: DM/DA - Escova / Brush: 5 x 12 x 11,6 mm

(L x A x C / W x H x L), Terminal saída lado esquerdo / Left side terminal.

Original: F 000 AL1 013, 9 001 081 092

Partida / Starter: 9 000 081 010, F 000 AL0 401, F 000 AL0 402, F 000 AL0 306, F 000 AL0 313, F 000 AL0 414, F 000 AL1 919

Aplicação / Application: **CHEVROLET-GM:** CORSA 1.6 EFI, **VOLKSWAGEN:** GOL II / III 1.0 MI / 16V / TURBO, PARATI II / III / 1.0 MI / 16V / TURBO, FUSCA 1300 / 1500 / 1600, GOL 1.3, **GURGEL:** BR 800, TOCANTINS L / TR, **TRANSPORTER:** 1600 / VARIANT / II

Bosch

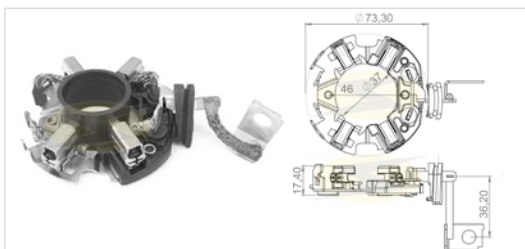

UF - 1.116/4 4 escovas / brushes

Especificações / Features: 12V, Tipo / Type: DM/DA - Escova / Brush: 5 x 12 x 11,6 mm

(L x A x C / W x H x L), Terminal saída lado direito / Right side terminal.

Original: 1 004 336 809, F 000 AL1 054, F 000 AL1 055, F 000 AL1 283

Partida / Starter: 0 001 107 027, 0 001 107 028, 0 001 107 044, 0 001 107 059, 0 001 107 063, 0 001 107 076, 0 001 107 082, 0 001 113 009, 9 000 081 003, F 000 AL0 003, F 000 AL0 301, F 000 AL0 302, F 000 AL0 304, F 000 AL0 309, F 000 AL0 310, F 000 AL0 314, F 000 AL0 400

Aplicação / Application: **FORD:** ESCORT / ORION 1.6i 16V / KA 1.3i / ESCORT 1.3 / TURNIER / 1.4 / CABRIO / EXPRESS 55 / 75, **OPEL:** CALIBRA 2.0i TURBO, **CITROEN:** BERLINGO 1.8i / EVASION 2.0i TURBO / XANTIA 1.6 / 1.8 / 2.0i / XM 2.0i / 16V TURBO / XSARA 1.8i / 16V / BREACK / COUPE / 2.0 / 16V / ZX / 1.8i, **FIAT:** DUCATO 10 / 13 / 14 / 18 / ULYSSE / PALIO 1.0 8V / UNO MILLE 1.0 SPI / WEEKEND 1.0 8V / STRADA 1.0 8V / DOBLO EX FIRE 1.3i / PALIO 1.0 / 1.3 MPI 16V / WEEKEND / SIENA / STRADA, **PEUGEOT:** 205 / 306 / 405 / 605

/ PARTNER, **VOLVO:** S40 / V40, **CHEVROLET-GM:** CORSA / CELTA, **VOLKSWAGEN:** GOL / PARATI / SAVEIRO / VOYAGE, **MERCEDES-BENZ:** CLASSE A 160

Bosch



UF - 1.117/4 4 escovas / brushes

Especificações / Features: 12V, Tipo / Type: DW/DB - Escova / Brush: 5 x 12 x 11,6 mm

(L x A x C / W x H x L), Terminal saída lado esquerdo / Left side terminal

Original: 1 004 336 801, 1 004 336 821, 1 004 336 827, 1 004 336 951, F 000 AL1 051, F 000

AL1 391

Partida / Starter: 0 001 106 015, 0 001 107 003, 0 001 107 007, 0 001 108 094, 0 001 107 016, 0 001 107 019, 0 001 107 020, 0 001 107 021, 0 001 107 022, 0 001 107 039, 0 001 107 054, 0 001 107 063, 0 001 107 066, 0 001 107 068, 0 001 107 091, 0 001 121 008, 0 001 121 009, 0 001 121 016, 0 001 121 028, 9 001 081 001

Aplicação / Application: **FORD:** ESCORT / MONDEO, **CITROEN:** BERLINGO / EVASION / XANTIA / XM / XSARA, **FIAT:** DUCATO 10 / 13 / 14 / 18 / ULYSSE / BRAVA / MAREA / WEEKEND / BRAVO / DOBLO / PALIO / WEEKEND / SIENA / STRADA, **PEUGEOT:** 205 / 306 / 405 /

605 / 806 / PARTNER, **VOLKSWAGEN:** PASSAT IMPORTADO / GOLF / BEETLE / GOL / LOGUS / PARATI / POINTER, **SEAT:** ALHAMBRA / CITY GOLF / CORDOBA / IBIZA, **AUDI:** AUDI A3 / TT / COUPE, **OPEL:** CORSA, **NISSAN:** SENTRA

Bosch

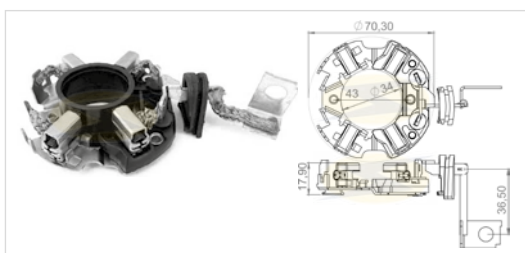

UF - 1.118/4 4 escovas / brushes

Especificações / Features: 12V, Tipo / Type: DW/DB - Escova / Brush: 5 x 12 x 11,6 mm

(L x A x C / W x H x L), Terminal saída lado direito / right side terminal.

Original: F 000 AL0 106, F 000 AL1 053

Partida / Starter: 0 001 107 015, (9 000 081 004), 9 000 081 005, 9 000 081 006, 9 000 081 007, 9 000 081 008, F 000 AL0 104, F 000 AL0 502, F 000 AL0 102, F 000 AL0 507

Aplicação / Application: **CHEVROLET-GM:** ASTRA / ASTRA SEDAN / BLAZER / IPANEMA / KADETT / OMEGA / SUPREMA / VECTRA / ZAFIRA, **OPEL:** ASTRA / CALIBRA / OMEGA / VECTRA, **FIAT:** TEMPRA / TURBO, **VOLKSWAGEN:** GOL / PARATI / QUANTUN / SANTANA / SAVEIRO / VOYAGE, **CITROEN:** XSARA / PICASSO

Bosch



UF - 1.119/4 4 escovas / brushes

Especificações / Features: 12V, Tipo / Type: DW - Escova / Brush: 5 x 12 x 11,6 mm

(L x A x C / W x H x L), Terminal saída lado direito / right side terminal

Original: 1 004 336 957, F 000 AL1 052

Partida / Starter: 0 001 107 015, F 000 AL0 100, 0 001 107 045

Aplicação / Application: **CHEVROLET-GM:** ASTRA 1.8 / 2.0 / I / SEDAN / 1.8 / 2.0 / I / MPFI / 16V, BLAZER 2.2 EFI / IPANEMA 2.0 MPFI / KADETT 2.0 MPFI / OMEGA 2.0 / 2.2i, SUPREMA 2.0 / 2.2 / 3.0i / S10 EFI / MPFI / VECTRA 2.0 / GSI 16V / ZAFIRA 2.0 / I / 16V, **OPEL:** ASTRA 2.0i / CALIBRA 2.0i TURBO / 16V / OMEGA 1.8 / 2.0 / I / VECTRA 2.0i / 16V / 2000 / 4X4, **FIAT:** FIORINO 1.0 / 1.5 (→1995), PALIO 1.6 16V / PALIO WEEKEND 1.0 / 1.5 8V (→96) / 1.6 16V, SIENA, STRADA 1.0 / 1.5 8V (→99), UNO 1.5 / MILLE

Bosch

UF - 1.124/4 4 escovas / brushes

Especificações / Features: 24V, Tipo / Type: EMT - Escova / Brush: 8,8 x 19 x 22 mm

(L x A x C / W x H x L) - 213/13, Quatro pólos isolados / Four isolated poles

Original: _____

Partida / Starter: 9 135 081 000

Aplicação / Application: EMPILHADEIRA / FORKLIFT

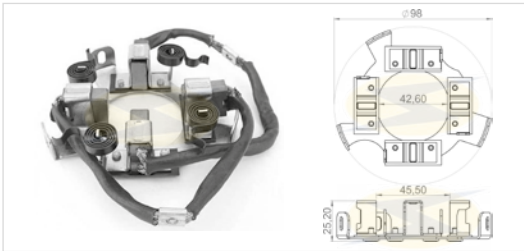

Bosch

UF - 1.125/4 4 escovas / brushes

Especificações / Features: 12V, Tipo / Type: DW - Escova / Brush: 5 x 16 x 13 (L x A x C/W x H x L),

mm GIRO SENTIDO HORÁRIO / Clock Wise Rotation, Terminal saída lado direito / Right side terminal.

Original: 1 004 336 806, 1 004 336 960, 1 004 336 968, 1 004 336 998

Partida / Starter: 0 001 108 128, 0 001 108 026, 0 001 108 064, 0 001 108 070, 0 001 108 080, 0 001 108 101, 0 001 108 102, 0 001 108 121, 0 001 108 130, 0 001 108 135, 0 001 108 136, 0 001 108 138, 0 001 108 139, 0 001 108 140, 0 001 108 143, 0 001 108 146, 0 001 108 155, 0 001 108 157, 0 001 108 159, 0 001 108 166, 0 001 108 167, 0 001 108 173, 0 001 108 176, 0 001 108 183, 0 001 115 079, F 010 AL0 103

Aplicação / Application: ALFA ROMEO: ALFA 155 2.0 T.S. / 156, BERLINA / SPORT WAGON /164 /166 / SPIDER, AUDI: 80 2.2 RS2 / QUATTRO S2 / S6 2.2 T. 100 2.2, 200 2.2 Turbo, BMW: 316 / 318 / 320 / 323 / 325 / I / 328 / 525 / I / 528 / Z3, CHEVROLET-GM: OMEGA 3.0 / 4.1 / I, SUPREMA 3.0 / 4.1 / I, C20, SILVERADO 4.1, CHRYSLER: GRAND CARAVAN 3.0 I LE, CITROEN: EVASION 2.0i / Turbo, BERLINGO

1.8i, XANTIA 1.6 / 1.8 / 2.0, XM 2.0, XSARA 1.8 / 2.0 / TURBO, ZX 2.0i, PICASSO 2.0 TURBO, FIAT: ULYSSE 1.8 / 1.9 / 2.0 / 2.1 / I.E. / TD / Turbo, CROMA 2.0 / I.E. / 16V / Turbo, BRAVA, FIORINO, MAREA, PALIO, SIENA, STILO, STRADA, FORD: ESCORT 2.0i 16V RS 2000 / 4X4 / ESCORT 1.8 i 16V XR3 CABRIOLET / TURNIER, EUROLINE / NUGGET / SCORPIO / TOURNEO / TRANSIT, MONDEO 1.8 / 2.0 I, OPEL: OMEGA 2.4 / 2.6 / 3.0 / 3.6 / I, PEUGEOT: 306 1.8 / 2.0 / I / 16V, 405 1.8 / 2.0, 605 2.0i 16V / 3.0i 24V, 806 2.0i, PARTNER 1.8i, RENAULT: BERLINGO 1.9 I, PARTNER 1.9 I, CLIO 2.0i WILLIAMS, LAGUNA 2.0i, VOLKSWAGEN: GOL, KOMBI, PARATI, SAVEIRO 1.6 / 1.9, TRANSPORTER, VOLVO: C70 / S70 / V70 / 850 - 2.5 GLT / Turbo / R / T-5 / T-5R / S40 - 1.8 / 2.0 16V / V40 - 1.8 16V

Bosch

UF - 1.126/4 4 escovas / brushes

Especificações / Features: 12V, Tipo / Type: DW - Escova / Brush: 5 x 16 x 13 mm

(L x A x C / W x H x L), GIRO SENTIDO ANTI-HORÁRIO / Counter Clockwise Rotation, Terminal saída lado esquerdo / Left side terminal.

Original: 1 004 336 811

Partida / Starter: 0 001 107 003, 0 001 108 076, 0 001 108 099, 0 001 108 050, 0 001 108 059, 0 001 108 060, 0 001 108 077, 0 001 108 096, 0 001 108 127, 0 001 108 168, 0 001 111 001, 0 001 111 005

Aplicação / Application: LADA (SHIGULI): SAMARA 1.3 / 1.5 / FUN, FIAT: TEMPRA 2.0 I.E. S.W., TIPO 1.8 / 2.0 / I.E. / 16V, VOLKSWAGEN: GOLF 1.8 / II 1.8, PASSAT (IMPORTADO) 2.0

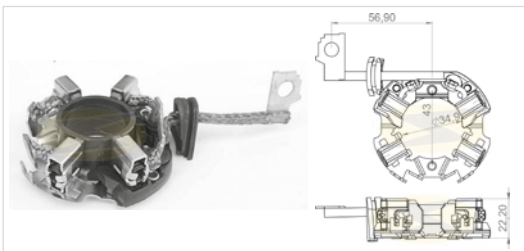

Bosch

UF - 1.127/4 4 escovas / brushes

Especificações / Features: 12V, Tipo / Type: DW/DB - Escova / Brush: 6 x 18 x 14,5 mm

(L x A x C / W x H x L), GIRO SENTIDO ANTI-HORÁRIO / Counter Clockwise Rotation, Terminal saída lado esquerdo / Left side terminal.

Original: 1 004 336 800, 1 004 336 847, 1 004 336 884, 1 004 336 906, 1 004 336 926, 1 004 336 933, 1 004 336 958, 1 004 336 983, 1 004 336 990, 1 004 336 991

Partida / Starter: 0 001 110 047, 0 001 110 059, 0 001 110 076, 0 001 110 086, 0 001 125 005, 0 001 125 011, 0 001 125 048, 0 001 125 018, 0 001 125 042, 0 001 125 012, 0 001 109 011, 0 001 109 012, 0 001 110 001, 0 001 110 002, 0 001 110 009, 0 001 110 010, 0 001 110 014, 0 001 110 015, 0 001 110 018, 0 001 110 031, 0 001 110 033, 0 001 110 057, 0 001 110 062, 0 001 110 069, 0 001 110 070, 0 001 110 077, 0 001 110 081, 0 001 110 084, 0 001 110 087, 0 001 110 099, 0 001 110 118, 0 001 110 119, 0 001 124 001, 0 001 124 005, 0 001 124 006, 0 001

124 007, 0 001 124 011, 0 001 124 014, 0 001 125 001, 0 001 125 002, 0 001 125 006, 0 001 125 013, 0 001 125 016, 0 001 125 019, 0 001 125 031

Aplicação / Application: AUDI: A3 1.8 T, S3 QUATTRO, TT COUPE / TT ROADSTER 1.8T QUATTRO, PORSCHE: 911 3.6 CARRERA / TARGA / TURBO, SEAT: CORDOBA 1.9 DIESEL / TURBO / SDI / TDI, IBIZA 1.9 DIESEL / TURBO, ALHAMBRA 2.8, VOLKSWAGEN: PASSAT (IMPORTADO) 2.8 VR6, GOLF IV 1.9 / 2.3 / TDI / V5 / 4 MOTION / VARIANT, TRANSPORTER CALIFORNIA / CARAVELLE / MULTIVAN 1.9 / 2.4, HYUNDAI: AEROVAN

Bosch

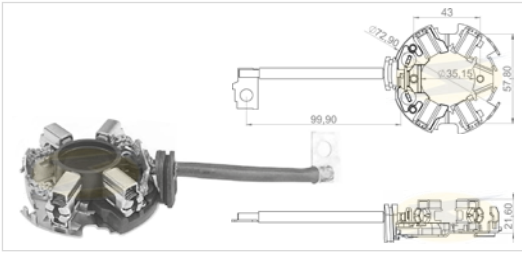

UF - 1.128/4 4 escovas / brushes

Especificações / Features: **12V, Tipo / Type: DW** - Escova / Brush: 6 x 18 x 14,5 mm
(L x A x C / W x H x L), GIRO SENTIDO HORÁRIO / Clockwise Rotation, Terminal saída lado direito / Right side terminal.

Original: 1 004 336 835, 1 004 336 908, 1 004 336 949

Partida / Starter: 0 001 108 182, 0 001 110 003, 0 001 110 026, 0 001 110 095

Aplicação / Application: **RENAULT:** CLIO 1.0 I 8V / 1.6 I, EXPRESS, EXTRA, RAPID 1.6 / 1.7, NOVO SCÊNIC

Bosch

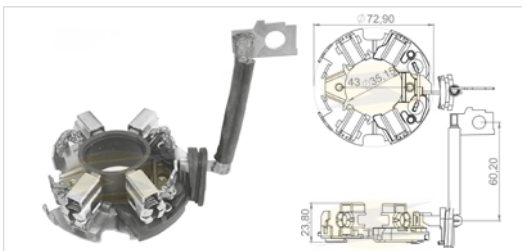

UF - 1.129/4 4 escovas / brushes

Especificações / Features: **12V, Tipo / Type: DW/DB** - Escova / Brush: 6 x 18 x 14,5 mm
(L x A x C / W x H x L), Terminal saída lado direito / Right side terminal.

Original: 1 004 336 807, 1 004 336 826, 1 004 336 942, 1 004 336 959, 1 004 336 981, 1 004 336 996

Partida / Starter: 0 001 109 021, 0 001 109 306, 0 001 110 011, 0 001 110 017, 0 001 110 025, 0 001 110 041, 0 001 110 079, 0 001 110 104, 0 001 109 036, 0 001 109 040, 0 001 110 029, 0 001 110 063, 0 001 124 015, 0 001 110 120, F 000 AL0 111

Aplicação / Application: **AUDI:** A6 / A8 QUATTRO 4.2, CABRIOLET 1.9, S6 / S8 4.2, **BMW:** M5 3.8 / TOURING, **FIAT:** DUNA 1.7 D / WEKEND, **FORD:** COURIER 1.8 DIESEL, ESCORT 1.8 - EXPRESS 55 / 75 / CABRIO / TURNIER / DIESEL / TURBO, MONDEO 1.8 TURBO, **IVECO:** DAILY, **JAGUAR:** XJ6 4.0, **MERCEDES-BENZ:** SPRINTER 312 D / 410 D, **PEUGEOT:** 306 1.9 D, 405 1.9 D, **PORSCHE:** BOXTER 2.5I, **RENAULT:** SAFRANE 2.2I, **LAND ROVER:** DEFENDER / DISCOVERY / RANGE ROVER I / II, **VOLKSWAGEN:** PASSAT (IMPORTADO) 2.5 TDI, **VOLVO:** 850 2.5 GLT, 960 3.0

Bosch

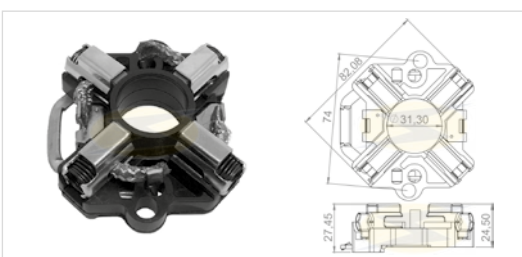

UF - 1.131/4 4 escovas / brushes

Especificações / Features: **12V, Tipo / Type: EV** - Escova / Brush: 7,5 x 18 x 17 mm (L x A x C / W x H x L), GIRO SENTIDO HORÁRIO / Clockwise Rotation

Original: 9 003 334 314, 1 004 112 906, 1 004 112 907

Partida / Starter: 9 000 331 411, 9 000 331 419, 9 000 331 432, 9 000 331 433, 0 001 218 128, 0 001 218 135, 0 001 218 004, 0 001 218 006, 0 001 218 009, 0 001 218 012, 0 001 218 013, 0 001 218 015, 0 001 218 016, 0 001 218 018, 0 001 218 019, 0 001 218 021, 0 001 218 023, 0 001 218 025, 0 001 218 029, 0 001 218 101, 0 001 218 103, 0 001 218 107, 0 001 218 115, 0 001 218 118, 0 001 218 126, 0 001 218 142, 0 001 218 152, 0 001 218 153, 0 001 218 158, 0 001 218 160, 0 001 218 161, 0 001 218 163, 0 001 218 176, 0 001 218 122, (0 001 218 011), 0 001 218 125, 0 001 218 137, 0 001 218 138, 0 001 218 140, 0 001 218 159, 0 001 218 165, (0 001 218 108), 0 001 218 168, 0 001 218 174, 0 001 218 177, 0 001 218 136, 0 001 218 157, 0 001 218 171, 6 003 AB1 J00

Aplicação / Application: **OPEL:** FRONTERA 2.3 TD, OMEGA 2.3 D / DT, **ALFA ROMEO:** ALFA 33 1.8 / SW / TD, 155 2.5 TD, 164 2.5 TD, **CHRYSLER:** VOYAGER 2.5 TD, **ROVER:** 825 2.5 TD, **MERCEDES-BENZ:** CLASSE SL 600 COUPE / SEC / V12 / SEL, MB 100 D / 180 D, SPRINTER 310 D / 312 D / 412 D, **FIAT:** DUCATO - 10 / 14 / 18 - 2.5 D / DT / EGR / ECO / 4X4, **BMW:** 750 I / II, 850 I / CI / Csi, **CHEVROLET-GM:** BLAZER 2.5 DIESEL, **DODGE:** DAKOTA 2.5 D, **FORD:** COURIER 1.8 DIESEL, ESCORT 1.8 - EXPRESS 55 / 75 / CABRIO / TURNIER / DIESEL / TURBO, MONDEO 1.8 TURBO DIESEL, F-1000 / F-1000 HSD, **IVECO:** DAILY 10, **MARCOPOLO:** VOLARE, **PEUGEOT:** BOXER 2.5 TDI, **RENAULT:** EXPRESS, EXTRA, RAPID 1.6, **LAND ROVER:** DEFENDER / DISCOVERY - 2.5 TDI / Turbo / Diesel / RANGE ROVER I - 2.5 TDI CLASSIC, RANGE ROVER II 2.5, **SSAN-GYONG:** MUSSO 2.9 DIESEL

Bosch

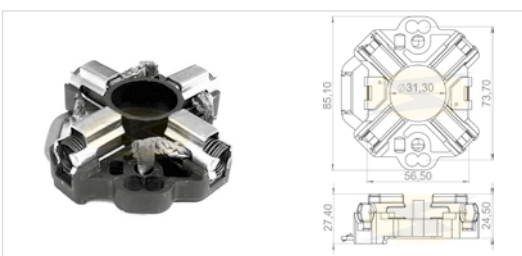

UF - 1.132/4 4 escovas / brushes

Especificações / Features: **12V, Tipo / Type: EV** - Escova / Brush: 7,5 x 18 x 17 mm (L x A x C / W x H x L) GIRO SENTIDO ANTI-HORÁRIO / Counter Clockwise Rotation

Original: 9 003 334 341, 9 003 334 158

Partida / Starter: 0 001 218 116, 0 001 218 117, 0 001 218 148, 0 001 218 149, 0 001 218 149

Aplicação / Application: **IVECO:** CAMINHÕES

Bosch

UF - 1.136

Especificações / Features: **24V, Tipo / Type: JE** - Escova / Brush: 9 x 36 x 18 mm

UF - 1.136/2 2 escovas / brushes

(L x A x C / W x H x L)

UF - 1.136/4 4 escovas / brushes

Original: 2 004 336 077, 2 004 336 078

Partida / Starter: 0 001 371 005, 0 001 371 009, 0 001 371 004, 0 001 371 006, 0 001 371 008

Aplicação / Application: **SCANIA:** DSI / 114 / P / R / T / DS / 1468 / 1469 / 1473 / 1474 / 1475 / 1478 / M / 1194 / 1198 / 1199 / 1174 / 1175 / 1176 / 1177 / 1178 / 1179 / RT 144-460 / 530, R-164-480 / 580 / DSC, 124-K / T / R-124 / T-124-360 / 400 / 420, P-114 / R114 / 340 / T-114 / 340

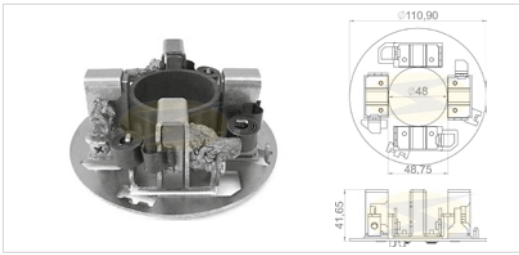

Bosch

UF - 1.150

Especificações / Features: **24V, Tipo / Type: JF/DD** - Escova / Brush: 7,5 x 25 x 17 mm

UF - 1.150/2 2 escovas / brushes

(L x A x C / W x H x L)

UF - 1.150/4 4 escovas / brushes

Original: 2 004 336 031

Partida / Starter: 0 001 368 306, 0 001 368 001, 0 001 368 069, 0 001 368 301, 0 001 368 309, 0 001 368 002, 0 001 368 005, 0 001 368 007, 0 001 368 009, 0 001 368 010, 0 001 368 012, 0 001 368 013, 0 001 368 016, 0 001 368 018, 0 001 368 019, 0 001 368 020, 0 001 368 021, 0 001 368 024, 0 001 368 027, 0 001 368 028, 0 001 368 030, 0 001 368 034, 0 001 368 035, 0 001 368 036, 0 001 368 038, 0 001 368 040, 0 001 368 055, 0 001 368 059, 0 001 368 063, 0 001 368 071, 0 001 368 085, 0 001 368 086, 0 001 368 300, 0 001 368 307

Aplicação / Application: **RENAULT:** SÉRIES: MIDLUM/ SZM/ 135/ 150/ 180/ 210/ 220/ 250/ 270/ 300/ CE/ DI/ G/ JE/ MI/ ME/ RI/ S/ SE, **IVECO:** SÉRIES: 60 / 75 / 80 / 90 / 110 / 120 / 130, **CASE:** 900 - 988 - C/ MOTOR / W/ MOTOR 6T, **SCANIA:** SÉRIES: 93 / 94 / 124 / 164, **MERCEDES-**

BENZ: O - O 371 U, OF 1115 / 1315, OH 1315 / 1318, **DAF, DEUTZ, FIAT, FORD, HANOMAG, IHC, KHD, MAGIRUS, VOLVO, WHITE, GMC: TRUCK**

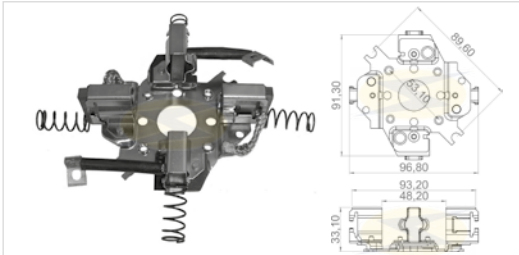

Bosch

UF - 1.151

Especificações / Features: **12V, Tipo / Type: JF/DD** - Escova / Brush: 9 x 16 x 17 mm

UF - 1.151/2 2 escovas / brushes

(L x A x C / W x H x L)

UF - 1.151/4 4 escovas / brushes

Original: 2 004 336 027, 2 004 336 041

Partida / Starter: 0 001 362 046, 0 001 362 081, 0 001 354 092, 0 001 362 020, 0 001 362 034, 0 001 362 036, 0 001 362 037, 0 001 362 039, 0 001 362 042, 0 001 362 045, 0 001 362 051, 0 001 362 058, 0 001 362 062, 0 001 362 069, 0 001 362 073, 0 001 362 077, 0 001 362 085, 0 001 362 093, 0 001 362 300, 0 001 362 303, 0 001 362 314, 0 001 362 321, 0 001 362 600, 0 001 362 700, 0 001 366 001, 0 001 366 003, 0 001 366 006, 0 001 366 009, 0 001 366 014, 0 001 366 021, 0 001 366 024, 0 001 366 026, 0 001 366 029

Aplicação / Application: **AUDI, CASE, KAEBLE:** 3 WT, WTV C/ MOTOR, **PEUGEOT:** 504 - 2.3 PICK-UP DIESEL, **DEUTZ, IHC, JOHN DEERE, KHD, MASSEY-FERGUSON, MERCEDES, NEW HOLLAND, VOLVO (DIESEL)**

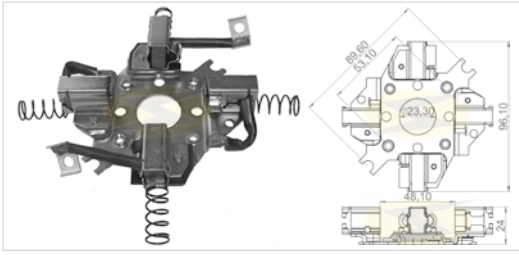

Bosch

UF - 1.152

Especificações / Features: **12V, Tipo / Type: JF/DD** - Escova / Brush: 10 x 25 x 17 mm

UF - 1.152/2 2 escovas / brushes

(L x A x C / W x H x L)

UF - 1.152/4 4 escovas / brushes

Original: 2 004 336 044, 2 004 336 028

Partida / Starter: 0 001 367 001, 0 001 367 002, 0 001 367 003, 0 001 367 004, 0 001 367 005, 0 001 367 006, 0 001 367 007, 0 001 367 008, 0 001 367 009, 0 001 367 010, 0 001 367 011, 0 001 367 012, 0 001 367 013, 0 001 367 014, 0 001 367 015, 0 001 367 016, 0 001 367 018, 0 001 367 021, 0 001 367 022, 0 001 367 023, 0 001 367 024, 0 001 367 025, 0 001 367 027, 0 001 367 028, 0 001 367 029, 0 001 367 030, 0 001 367 032, 0 001 367 034, 0 001 367 036, 0 001 367 039, 0 001 367 042, 0 001 367 044, 0 001 367 045, 0 001 367 046, 0 001 367 048, 0 001 367 050, 0 001 367 052, 0 001 367 055, 0 001 367 058, 0 001 367 063, 0 001 367 070, 0 001 367 076, 0 001 367 300

Aplicação / Application: **NEW HOLLAND:** 8000 - 8430 / 8630 / 8830 / 8430 / DT, **DEUTZ, FORD, IHC, IVECO, JOHN DEERE, KHD, MACK**

TRUCK, MAGIRUS, MASSEY FERGUSON, MERCEDES, RENAULT, VOLVO, SCANIA: TRUCK 93L

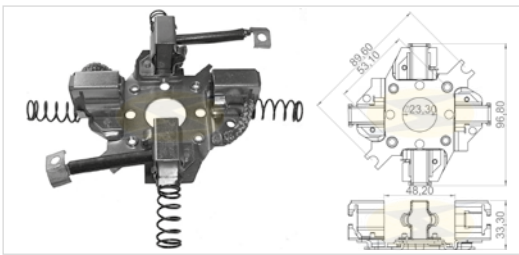

Bosch

UF - 1.162/4 4 escovas / brushes

Especificações / Features: **12V, Tipo / Type: EV** - Escova / Brush: 6,1 x 22 x 15,5 mm

(L x A x C / W x H x L), Cabo curto / Short cable

Original: 6 033 AD0 368, 6 033 AD1 244, 6 033 AD1 246

Partida / Starter: 0 001 223 003, 0 001 223 010, 0 001 223 013, 0 001 218 774, 0 001 218 174

Aplicação / Application: **IVECO:** CITY CLASS C/ MOTOR 2.8 8140.43S (10.2005 →), SCUDATO C/ MOTOR / W/ MOTOR 2.8 8140.43S (10.2005 →), DAILY C/ MOTOR 8140 (11.1997 →), DAILY 35 / 50 / C 9 / C 11 / C 13 / S 9 / S 11 / S 13, **FORD:** F 250 COM MOTOR MWM 6.07 TCA - (03/1999 →)

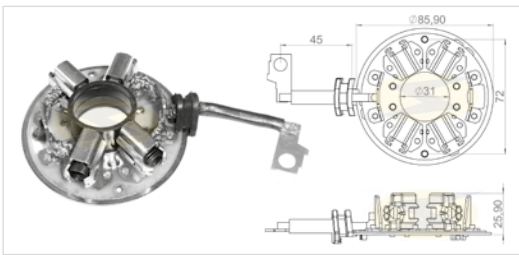

Bosch

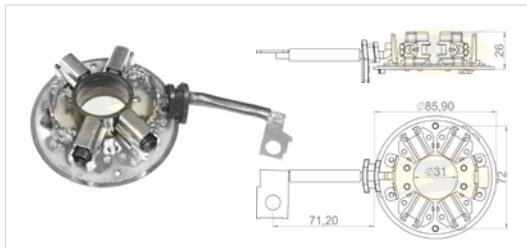

UF - 1.164/4 4 escovas / brushes

Especificações / Features: 12V, Tipo / Type: EV - Escova / Brush: 6,1 x 22 x 15,5 mm

(L x A x C / W x H x L), Cabo longo / Long cable

Original: 6 033 ADO 216, 6 033 ADO 404, 6 033 ADO 409, 6 033 ADO 370, 6 033 AD1 250,

6 033 AD1 255

Partida / Starter: 0 001 223 002, 0 001 223 004, 0 001 223 016, 0 001 223 021, 0 001 223 022, 0 001 223 505, 0 001 230 007, F 000 AL0 130

Aplicação / Application: CATERPILLAR, DEUTZ: MOTORES MARÍTIMOS / MARINE ENGINES BF4L1011 (2.71L-2.732CC), F2L1011 (1.4L-1366CC), F3L1011 (2.0L-2049CC), F4L1011 (2.7L-2732CC), FORD: F 250, F-350 E F-4000 COM MOTOR CUMMINS 4BTAA - (11/1998-), ISUZU, IVECO: DAILY 35 / 50 C / S (MOTORES / ENGINES 9 8140.63.4000, 9 8140.63.4030, 9 8140.63.4000, 9 8140.63.4020 / S, 9 8140.63.4030, 11 8140.43C, 13 8140.43S, 11 8140.43C, 13 8140.43S, 11 8140.43C, 13 8140.43S), KHD: MOTORES / ENGINES F2L1011 (1.4L-1366CC) (1995), F3L1011

(2.0L-2049CC) (1995), F4L1011 (2.7L-2732CC) (1995), NEW HOLLAND: TL 70 / 75 / 80 / 90 / 100 (09/1997-), THOMAS EQUIPMENT: MINI CARREGADEIRAS / SKID STEERS T243 MOTOR / ENGINE DEUTZ BF4M1011F DSL (1997-2000)

Bosch

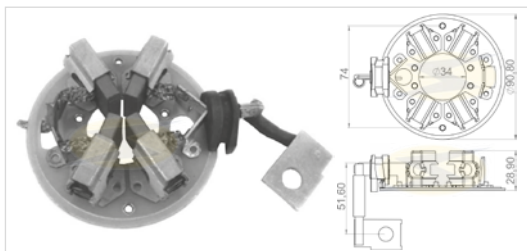

UF - 1.165/4 4 escovas / brushes

Especificações / Features: 24V, Tipo / Type: EV - Escova / Brush: 6,5 x 25 x 16,5 mm

(L x A x C / W x H x L)

Original: 6 033 ADO 189, 6 033 AD4 054

Partida / Starter: 0 001 231 002, 0 001 231 033

Aplicação / Application: MERCEDES-BENZ: SÉRIE 7T-712C, 9T-915 / 914C / LO, 12TL-L1218, 14TL-L1418, 16TL-L1618M / L1622, 24T-2423, O-0500M / O500R / O500U, VOLKSWAGEN

Bosch

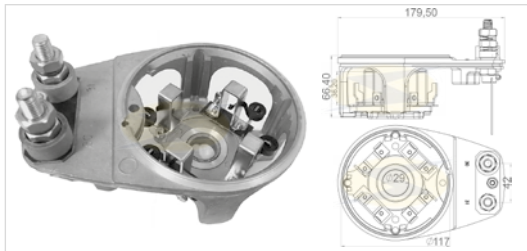

UF - 1.166

Especificações / Features: 24V, Tipo / Type: KB - Escova / Brush: 12 x 36 x 27 mm

(L x A x C / W x H x L), (BSX 60)

Original: 2 005 855 110, 9 001 084 104

Partida / Starter: 9 000 084 007, 9 000 084 008, 9 000 084 009, 9 000 084 011, 9 000 084 012, 9 000 084 013, 9 000 084 014, 9 000 084 015, 9 000 084 016, 9 000 084 018, 9 000 084 020, 9 000 084 022, 9 000 084 023, 9 000 084 024, 9 000 084 026, 0 001 416 009, 0 001 416 036, 0 001 416 061, 0 001 416 071, 0 001 417 005, 0 001 417 023, 0 001 417 036, 0 001 417 042, 0 001 417 047, 0 001 417 055, 0 001 417 064

Aplicação / Application: ATLAS COPCO: SÉRIE AX, CASE: SÉRIES: 800 / 2000 / 4000 / W., CATERPILLAR: SÉRIES 631E / D8L / D / 100 / 900 / 3300, CUMMINS: SÉRIES C / CT / CTA / N, DECAROLI: SL, EL DETALLE: SÉRIE AO, FIAT: SÉRIE 190, FIAT-ALLIS: SÉRIES AD / FD / FG / FR, IVECO: SÉRIE 180 / 190 / 240 / 260 / 440 / 450 / 619, KOMATSU: SÉRIES A / D / GD / R / WA, LIEBHERR, MAFERSA: SÉRIE M, MASSEY-FERGUSON:

SÉRIE MF 4000, MERCEDES-BENZ: SÉRIES 13TL / 14TL / 15TL / 19TL / 20TL / 22TL / 26TL / O / OH, MWM DIESEL, SCANIA: SÉRIES 112 / 113 / 142 / BR / DN / DS / DSC / DSI, VOLKSWAGEN: SÉRIES 14T / 16T, VOLVO: SÉRIES B7R / B10 / C10 / F80 / FM10 / G / N10 / N12 / N80 / NL10 / NL12, VOLVO PENTA

Bosch

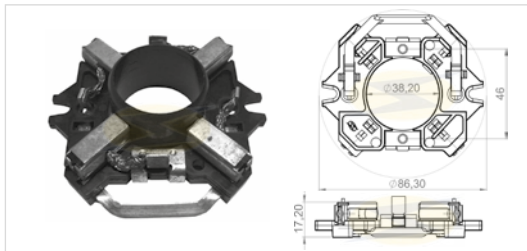

UF - 1.174/4 4 escovas / brushes

Especificações / Features: 12V, Tipo / Type: DD - Escova / Brush: 7 x 10 x 15 mm

(L x A x C / W x H x L)

Original: 1 004 336 901

Partida / Starter: 0 001 208 702, 0 001 208 705, 0 001 208 706, 0 001 208 707, 0 001 208 708, 0 001 208 709-715, 0 001 208 717-719, 9 000 333 106, 9 000 333 114, 9 000 333 117

Aplicação / Application: MATRA, TALBOT, ALFA-ROMEU, AUDI, BMW, CITROEN, FIAT, FORD, LANCIA, MERCEDEZ-BENZ, OPEL, PEUGEOT, RENAULT, SAAB, SEAT, VOLVO, VOLKSWAGEN

Bosch

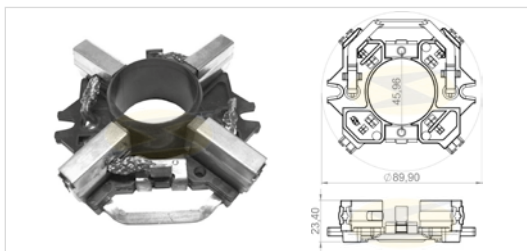

UF - 1.175/4 4 escovas / brushes

Especificações / Features: 12V, Tipo / Type: DD - Escova / Brush: 7 x 16 x 15 mm

(L x A x C / W x H x L)

Original: 1 004 336 900

Partida / Starter: 0 001 312 108, 0 001 312 109, 0 001 317 007-013, 0 001 317 016-019, 0 001 317 022-025

Aplicação / Application: AUDI, OPEL, VAUXHALL, TRANSPORTER, VOLKSWAGEN: GOLF DIESEL TURBO, CHEVROLET-GM: KADETT, FORD: ESCORT

Bosch

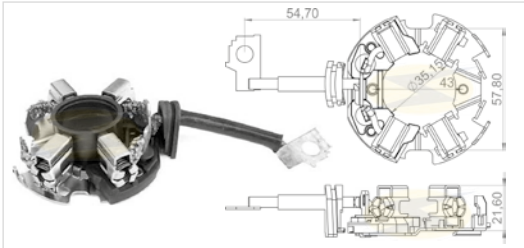

UF - 1.194/4 4 escovas / brushes

Especificações / Features: **12V, Tipo / Type: DW** - Escova / Brush: 6 x 18 x 14,5 mm

(L x A x C / W x H x L), Terminal saída lado esquerdo / Left side terminal terminal

Original: 1 004 336 445, 1 004 336 836

Partida / Starter: F 000 ALO 105, F 000 ALO 107, F 000 ALO 112, F 000 AL1 973, 0 001 109 018, 0 001 109 048, 0 001 109 306

Aplicação / Application: **CHEVROLET-GM:** S10 / BLAZER 2.5 DIESEL 4.07 TCA / 2.8 DIESEL SPRINT MWM, **FIAT, IVECO, LANCIA, MERCEDES-BENZ, NISSAN:** FRONTIER / X-TERRA C/ MOTOR / W/ENGINE MWM 2.8 SPRINT (05.2004→), **TROLLER:** T4, PANTANAL 2.8 MWM SPRINT, **AGRITECH/ YANMAR:** BTD (05.2004→)

Bosch

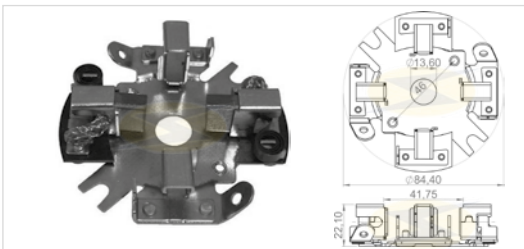

UF - 1.197

Especificações / Features: **12V, Tipo / Type: EF** - Escova / Brush: 7 x 16 x 18 mm

UF - 1.197/2 2 escovas / brushes

(L x A x C / W x H x L)

UF - 1.197/4 4 escovas / brushes

Original: 1 004 336 046

Partida / Starter: 0 001 312 103, 0 001 314 005, 0 001 314 018, 0 001 314 025

Aplicação / Application: **VOLKSWAGEN 12 VOLTS (MÉXICO)**

Bosch

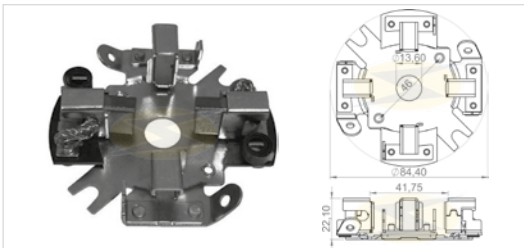

UF - 1.198/2 2 escovas / brushes

Especificações / Features: **6V, Tipo / Type: EF** - Escova / Brush: 7 x 16 x 18 mm

UF - 1.198/4 4 escovas / brushes

(L x A x C / W x H x L)

Original: 1 004 336 027, 9 001 042 176

Partida / Starter: 0 001 207 003, 0 001 207 005, 0 001 207 009, 0 001 207 015, 0 001 207 018

Aplicação / Application: **VOLKSWAGEN 6 VOLTS (MÉXICO)**

Bosch

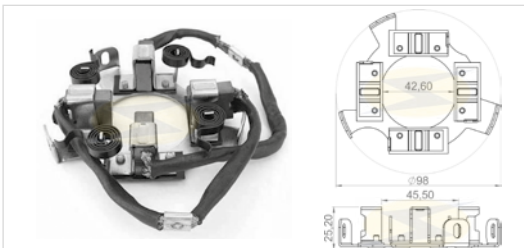

UF - 1.201/4 4 escovas / brushes

Especificações / Features: **12V** - Escova / Brush: 8,8 x 19 x 22 mm (L x A x C / W x H x L),

Quatro pólos isolados / Four isolated poles

Original:

Partida / Starter: WAPSA 12 volts

Aplicação / Application: **EMPILHADERA / FORKLIFT E PLATAFORMAS / FLATBED TRUCKS**

Bosch

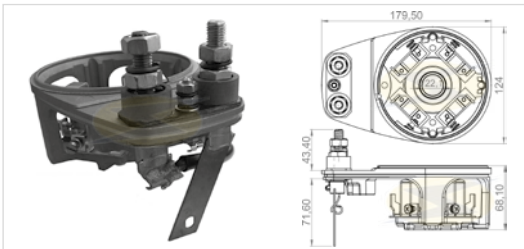

UF - 1.206

Especificações / Features: **24V, Tipo / Type: KB** - Escova / Brush: BSX 12 x 36 x 27

UF - 1.206/4 4 escovas / brushes

mm (L x A x C / W x H x L), (BSX 60), Isolado / Isolated.

Original: 9 001 084 126

Partida / Starter: 9 000 084 011

Aplicação / Application: **MOTORES ESTACIONÁRIOS E MARÍTIMOS / STATIONARY AND MARINE ENGINES**

Bosch

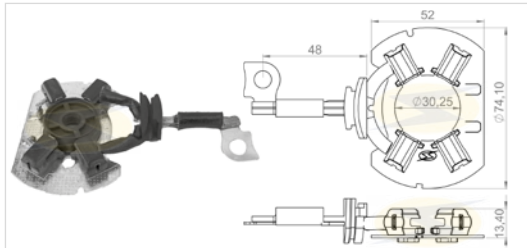

UF - 1.210/4 4 escovas / brushes

Especificações / Features: 12V, Tipo / Type: K1 - Escova / Brush: 4,5 x 8,7 x 10,5 mm

(L x A x C / W x H x L)

Original: F 000 CD1 203

Partida / Starter: F 000 ALO 309, F 000 CD0 800, F 000 CD0 A0, 51888975, 51865316

Aplicação / Application: CHEVROLET: MONTANA, FIAT: FIORINO 1.3 FIRE, DOBLO, PALIO, IDEA, UNO, STRADA 1.4 / 1.6, PUNTO, BRAVO. TODOS MOTORES / All Engines: E. TORQ. VOLKSWAGEN: GOL, VOYAGE 1.0 / 1.6

Bosch

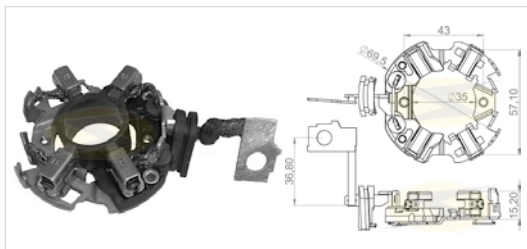

UF - 1.217/4 4 escovas / brushes

Especificações / Features: 12V, Tipo / Type: DW - Escova / Brush: 5 x 12 x 11,6 mm

(L x A x C / W x H x L), Terminal saída lado direito / Right side terminal

Original: F 000 AL1 171, F 000 ALO 106

Partida / Starter: 0 001 107 075

Aplicação / Application: TOYOTA: COROLLA / FIELDER 1.8i 16V (08.1998→06.2002)

Bosch

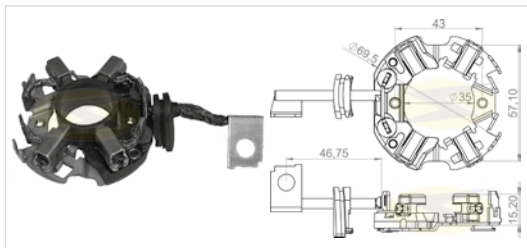

UF - 1.218/4 4 escovas / brushes

Especificações / Features: 12V, Tipo / Type: DW - Escova / Brush: 5 x 12 x 11,6 mm

(L x A x C / W x H x L), Terminal saída lado direito / Right side terminal

Original: 1 004 336 985

Partida / Starter: 0 001 107 037, 0 001 107 048, 0 001 107 056, 0 001 107 072

Aplicação / Application: ALFA ROMEO, AUDI, CITROEN, LANCIA, OPEL, PEUGEOT, RENAULT, SEAT, VAUXHALL, VOLKSWAGEN

Bosch

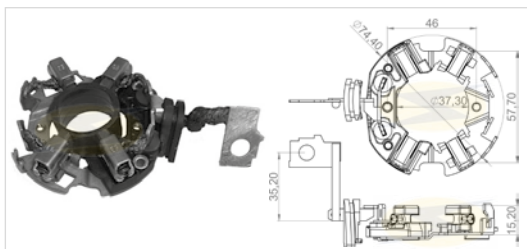

UF - 1.219/4 4 escovas / brushes

Especificações / Features: 12V, Tipo / Type: DM - Escova / Brush: 5 x 12 x 11,6 mm (L x A x C /

W x H x L), Base maior que UF-1.217/4 e UF-1.218/4 / Bigger than UF-1.217/4 and UF-1.218/4

Original: 9 001 081 094, 9 001 081 068

Partida / Starter: 9 001 081 009, F 000 ALO 300, F 000 ALO 305, F 000 AL1 094

Aplicação / Application: FIAT: UNO MILLE 1.0 5P (1995→2001), PALIO 1.0 MPI 8V, (1996→2001), SIENA, PALIO WEEKEND, STRADA

Bosch

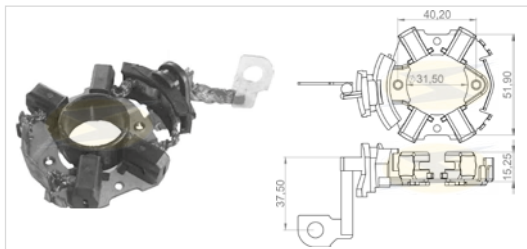

UF - 1.222/4 4 escovas / brushes

Especificações / Features: 12V, Tipo / Type: DB / LT - 1,1 Kw - Escova / Brush: 4,5 x 10 x 13 mm

(L x A x C / W x H x L), CCW - Counter Clock Wise / Sentido Anti-horário

Original: 1 004 336 526, 1 004 336 842, 1 004 336 879, 1 004 336 957, 1 004 337 027

Partida / Starter: 0 000 112 040, 0 001 107 025, 0 001 121 422, 0 001 120 400, 0 001 120 401, 0 001 120 402, 0 001 120 403, 0 001 120 404, 0 001 120 405, 0 001 120 406, 0 001 120 407, 0 001 120 408, 0 001 120 409, 0 001 120 410, 0 001 120 411, 0 001 120 412, 0 001 120 440, 0 001 121 402, 0 001 121 403, 0 001 121 408, 0 001 121 409, 0 001 121 410, 0 001 121 411, 0 001 121 412, 0 001 121 413, 0 001 121 422, 0 001 121 423, 0 001 121 427, 0 001 121 428, 0 001 121 440, 0 001 121 443, 0 001 121 444

Aplicação / Application: AUDI: A3 1.4 TFSI / 1.6 / 1.6 SPORTBACK, A3 1.8 TFSI / QUATTRO / SPORTBACK, A3 2.0 FSI SPORTBACK / TFSI / QUATTRO / TFSI SPORTBACK / QUATTRO / TFSI, TT 2.0 TFSI / QUATTRO, A4, BMW: X1, FIAT: BRAVO, PALIO WEEKEND (2011),

LINEA 1.8 (E-TORQ), UNO FIRE, STRADA 1.8 (2011), FORD: MONDEO, LAND-ROVER: RANGE ROVER, SEAT: IBIZA 1.8 TURBO CUPRA R / 2.0, ALTEA 1.4 / 1.6 / 1.8 / 2.0, CORDOBA 2.0, LENON 1.6 / 1.6 16V / 1.8 TSI / 2.0 FSI / 2.0 TFSI, TOLEDO 1.6 / 1.8 TFSI / 2.0 FSI / 2.0 TFSI, SKODA: OCTAVIA 1.4 / 1.6 / 1.8 / 2.0 / 2.0 FSI 4X4, SUPERB 1.4 / 1.8, VOLKSWAGEN: EOS 1.4 / 2.0, GOLF V 1.4 TSI / 1.4 TSI PLUS, GOLF V 1.6 / 1.6 PLUS / 1.6 PLUS MULTIFUEL, GOLF V 2.0 / FSI / FSI 4 MOTION / FSI PLUS / GTI, GOLF VI 1.4 TSI / 1.6 / 1.6 BIFUEL / 2.0 TSI, JETTA 1.4 TSI / 1.6 / 2.0 / 2.0 FSI / 2.0 TFSI / 2.5, MULTIVAN 2.0, PASSAT 1.4 TSI / 1.4 TSI ECOFUEL / 1.6 FSI / 1.8 TSI / 2.0 FSI / 2.0 FSI 4 MOTION, POLO 1.8 GTI / 1.8 GTI CUP EDITION, SIROCCO 1.4 / 2.0, TOURAN 1.4 / 2.0

Bosch

UF - 1.223/4 4 escovas / brushes

Especificações / Features: 12V, Tipo / Type: LT e PDM (JF / JD Moderno / New) - 3,0 Kw -

Escova / Brush: 6 x 18 x 14,5 mm (L x A x C / W x H x L)

Original: 1 004 336 518, 1 004 336 586, 1 004 336 599, 6 004 AE0 016

Partida / Starter: 0 001 109 300, 0 001 109 301, 0 001 109 306, 0 001 109 307, 0 001 109 309, 0 001 109 310, 0 001 109 330, F 000 ALO 111, F 000 ALO 128, F 000 ALO 129, F 000 ALO 130, F 000 ALO 138, F 000 ALO 139, F 004 A94 008, F 004 A94 011, 900008328, 9000083054

Aplicação / Application: **FIAT:** DUCATO MULTIJET 2.3, **FORD:** CARGO ELETRONIC 715, 815, 1317, 1517, 1717, 1722, 2422, 2428, F-250 CUMMINS 4CC 3.9 ELETRONICO / ELECTRONIC (2006→2011), F-4000 CUMMINS (2010→), **IVECO:** DAILY, **TOYOTA:** HILUX / SW4 2.5 / 2.8 / 3.0 DIESEL (2002 →), **MERCEDES-BENZ:** CAMINHÃO L608D / 709 / 710 / 712 / LO 809 / LO 812 / LO 814 / 912 / 914 / L 1013 / L 1111 / L 1113 / L 1114 / L 1116 / L 1117 / L 1214 / L 1218 / L 1313 / L 1314 / L 1316 / L 1317 / L 1318 / L 1418 / L 1513 / L 1516 / L 1517 / L 1518 / L 1620

/ 1714 / 1718 / 1720 / 1721 / 1722 / 1723 / L 2013 / L 2014 / L 2016 / L 2213 / L 2214 / L 2216 / L 2217 / L 2218 / 2418 / O362 / 365 / OM 366 C/ MOTORES OM 314 / OM 364 / OM 352, ONIBUS / BUS O364 - MOTOR/ ENGINE OM352/ 352*, CAMINHÕES/ TRUCKS 1316, 1513, **NEW HOLLAND:** COLHEITADEIRA / COMBINE FNH 8040, 8255, **TOYOTA:** BANDEIRANTES - MOTOR / ENGINE OM 352 / 364

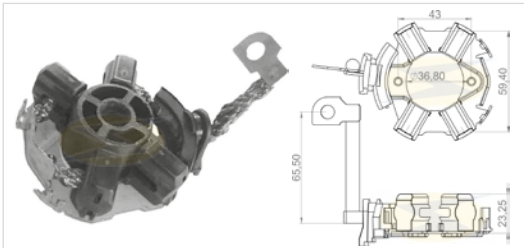

Bosch

UF - 1.224/4 4 escovas / brushes

Especificações / Features: 12V, Tipo / Type: LT - 1,4 Kw - Escova / Brush: 5 x 16 x 13,5 mm

(L x A x C / W x H x L)

Original: 1 004 336 530

Partida / Starter: 0 001 108 401, 0 001 108 411

Aplicação / Application: **BMW, FIAT:** DUCATO, **CITROEN, PEUGEOT, VOLVO:** S80 3.0L (2008), S80 3.2L T6 AWD (2007→2008), V70 III 3.2L, AWD 2008, XC60 T6 AWD 3.2, XC70 3.2L (2008), XC90 3.2L (2007→2008)

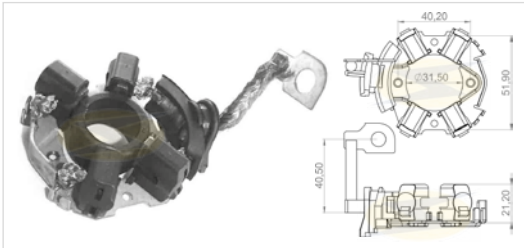

Bosch

UF - 1.225/4 4 escovas / brushes

Especificações / Features: 12V, Tipo / Type: LT - 1,8 Kw - Escova / Brush: 5 x 16 x 13,5 mm

(L x A x C / W x H x L)

Original: 1 004 336 228, 1 004 336 533, 1 004 336 511, 1 004 336 536, 1 004 336 566, 1 004 336 577, 1 004 336 579, 1 004 336 638, 1 004 336 712, 1 004 336 727, 1 004 336 770, 1 004 336 888

Partida / Starter: 0 001 108 202, 0 001 108 217, 0 001 108 218, 0 001 108 222, 0 001 108 223, 0 001 108 224, 0 001 108 230, 0 001 107 107, 0 001 151 4214

Aplicação / Application: **ALFA ROMEO, FIAT, LANCIA:** JTD, **MERCEDES-BENZ**

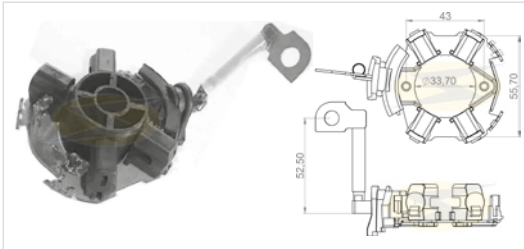

Bosch

UF - 1.226/4 4 escovas / brushes

Especificações / Features: 12V, Tipo / Type: LT - 1,4 Kw - Escova / Brush: 5 x 16 x 13,5 mm

(L x A x C / W x H x L)

Original: 1 004 336 533

Partida / Starter: 0 001 108 400, 0 001 108 406, 0 001 108 409

Aplicação / Application: **AUDI:** A4 / QUATTRO 3.2L (2005→2008), A6 / QUATTRO 3.2L (2005→2008), **CITROEN:** BERLINGO 1.9 / 2.0, C4 HATCHBACK 2.0 16V, C4 GRAND PICASSO 1.8 / 2.0 16V, C4 PICASSO 1.8 / 2.0 16V, C5 HATCHBACK / SALOON 1.8 16V, C5 BREAK ES-TATE 1.8 16V, JUMPY 1.9D / 2.0 HDI, XSARA HATCHBACK / COUPE / BRAKE STATE / PICASSO 2.0 HDI, **FIAT:** ULYSSES 2.0, **PEUGEOT:** 206 1.9D / 2.0 HDI, 306 1.9D / 2.0 HDI, 307 2.0 16V / HDI, 407 1.8 / 2.0 / 2.2 16V, EXPERT 1.9D, 2.0 HDI, PARTNER 1.9D / 1.9D 4X4 / 2.0 HDI, **MB:** CLASSES CL, CLK, CLS, E, G, M, S, SL 5.5L, GL 4.6L

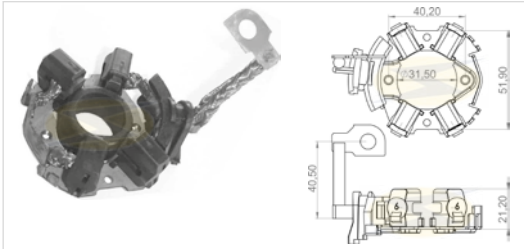

Bosch

UF - 1.227/4 4 escovas / brushes

Especificações / Features: 12V, Tipo / Type: CDS - Escova / Brush: 4,5 x 8,5 x 11 mm

(L x A x C / W x H x L)

Original:

Partida / Starter: F 000 CD0 001, F 000 CD0 002, F 000 CD0 003, F 000 CD0 9A0, F 000 CD1 020

Aplicação / Application: **RENAULT:** DUSTER, LOGAN 1.6 / MCV, SCENIC 1.6, MEGANE 1.6, SANDERO, TODOS / ALL 1.0 (2006→), **FIAT:** DOBLO 1.3 MPI 16V, IDEA 1.4 / FLEX, FIORINO FURGÃO 1.3 MPI 8V / FLEX, PALIO 1.0 / 1.3 / 1.4 / MPI 8V / 16V / FLEX / FIRE / WEEKEND, PUNTO 1.4 / FLEX, SIENA 1.0 / 1.3 / 1.4 / MPI 8V / 16V / FLEX / FIRE, STRADA 1.3 / 1.4 / 1.6 / FIRE / 8V, UNO (NOVO) / 1.3 / FIRE / MILLE 1.0 / FLEX, **DACIA:** DUSTER, LOGAN, LOGAN MCV, SANDERO

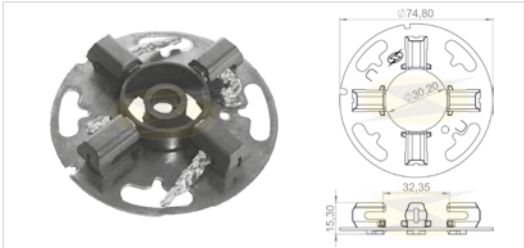

Bosch

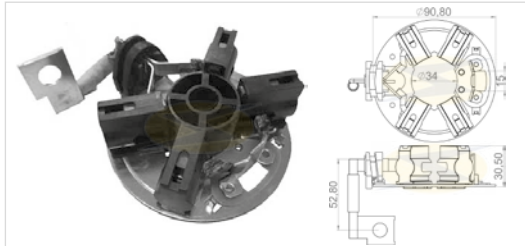

UF - 1233/4 4 escovas / brushes

Especificações / Features: 24V, Tipo / Type: HEF95-L24V - 5.5 Kw

Escova / Brush: 5.5 x 28 x 18 mm (L x A x C / W x H x L)

Original: 6 033 AD4 054, 6 033 AD4 194, 6 033 AD5 016, 6 033 AD5 128, 6 033 AD5 179, 6 033

AD5 194, 6 033 AD5 316

Partida / Starter: 0 001 230 030, 0 001 231 033, 0 001 241 001, 0 001 241 003, 0 001 241 005, 0 001 241 014, 0 001 241 015, 0 001 241 019, 0 001 241 020, 0 001 161 002, 0 002 242 002

Aplicação / Application: **SCANIA:** (2000→), T 340 DC 11.08 EURO 3 / T 380 DC 11.09 EURO 3, T 420 DC 12.14 EURO 3 / T 420 DT 12.11 EURO 4, T 470 DT 12.06 EURO 3, P 230 DC 9.13 EURO 3 / P 270 DC 9.12 EURO 3 / P 310 DC 9.11 EURO 3 / P 340 DC 11.08 EURO 3 / P 380 DC 11.09 EURO 3 / P 420 DC 12.14 EURO 3, P 230 DC 9.16 EURO 4 / P 270 DC 9.17 EURO 4 / P 310 DC 9.18 EURO 4 / P 340 DC

12.10 EURO 4 / P 380 DC 12.13 EURO 4, P 380 DC 12.18 EURO 5 / P 480 DT 12.17 EURO 4, P 420 DC 12.15 EURO 5, P 420 DT 12.12 EURO 4, P 470 DT 12.06 EURO 3, T 340 DC 11.08 EURO 3 / T 380 DC 11.09 EURO 3T 420 DC 12.14 EURO 3 / T 420 DT 12.11 EURO 4, T 470 DT 12.06 EURO 3, **KAMAZ:** 18t 5460 740.50-360 EURO 2, 27T 6520 740.51-320 EURO 2, **MBB:** AXIOR

Bosch

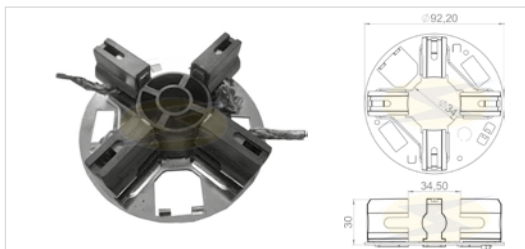

UF - 1235/4 4 escovas / brushes

Especificações / Features: 24V, 5.5 Kw Tipo / Type: HEF95-L24V -

Escova / Brush: 6.5 x 28 x 18 mm (L x A x C / W x H x L)

Original:

Partida / Starter: 0 001 261 001, 0 001 261 002, 0 986 021 480

Aplicação / Application: **SCANIA:** SERIES P / G / R / T (MOTORES ELETRÔNICOS / ELECTRONIC ENGINES): G 230 / G 230 E P 230 (2006→2007) / G 270 / P 270 / G 270 / P 270 E R 270 2004 / 1 / 9, G 310 / P 310 / G 310 E P 310 2004 / 09 / 01, G 340 / P 340 / G 340 E P 340 2004 / 08 / 01, G 340 / P 340 / R 340 / G 340 E R 340 2006 / 8 / 1, G 380 / P 380 / G 380 E P 380 2004 / 08 / 01, G 380 / P 380 E R 380 (2005→2008), G 420 / G 420 E R 420 2008 / 1 / 1, G 420 / P 420 E R 420 (2004→2005), G 420 E R 420 2008 / 1 / 1, G 480 E R 480 (2008), P 230 (2006→2008), P 230 E R 230 (2004→2006), P 270 E R 270 (2004→2006), P 280 / P 310 (2006→2008), P 310 E R 310 (2004→2006), P 340 (2004→2006),

P 340 E R 340 (2004→2006), P 380 (2004→2006), P 380 E R 380 (2004→2006), P 420 2004 / 09 / 01, P 420 E R 420 (2004→2006), P 470 E R 470 (2004→2005), P 480 E R 480 E R 340 2004 / 3 / 1, R 380 2004 / 3 / 1, R 380 2004 / 9 / 1, R 400 2008 / 3 / 1, R 420 / 440 R 2008 / 03 / 01, R 470 2004 / 1 / 4, R 480 2006 / 1 / 8, T 470 (2004→2005)

Bosch

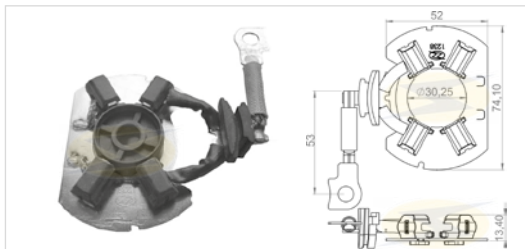

UF - 1238/4 4 escovas / brushes

Especificações / Features: 12V, Tipo / Type: K1 - Escova / Brush: 4,5 x 8,7 x 10,5 mm

(L x A x C / W x H x L)

Original: F 000 CD1 285

Partida / Starter: F 000 CD0 900, 0 001 121 439

Aplicação / Application: **VOLKSWAGEN:** GOL, VOYAGE 1.0 / 1.6, POLO, SAVEIRO, FOX, SPACEFOX 1.0 / 1.6, GOLF 2.0

Bosch

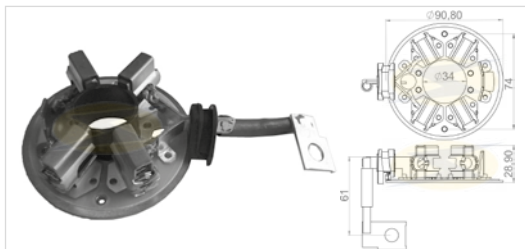

UF - 1239/4 4 escovas / brushes

Especificações / Features: 12V, Tipo / Type: PLGR 230 SERIES EV - 3.0 Kw -

Escova / Brush: 6,5 x 25 x 16,5 mm (L x A x C / W x H x L)

Original: 6033AD0166, 6033AD0374, 6033AD2022, 6033AD3267, 6033AD3042,

6033AD3328, 9003334368

Partida / Starter: 0001230002, 0001230003, 0001230004, 0001230005, 0001230006, 0001230007, 0001230008, 0001230009, 0001230011, 0001230018, 0001230020, 0001230021, 0001230022, 0001230023, 0001230025, 0001230026, 0001230027

Aplicação / Application: **NEW HOLLAND, JOHN DEERE:** COMBINE 2254 / 4045 / 5410 / 5415 / 5420 / 5510 / 5615 / 5715 / 6205 / 6505 / 6520 / 6620 / 6820 / 6920 / 6510 / 6520 / 6605 / 6610 / 6615 / 6620 / 6715 / 6810 / 6820 / 6910 / 6920 / 7220 / 7320 / 7420 / 7520 (MOTORES JD6068 2001→2006), RE501910, RE508815, RE508818, **FUCHS, LIEBHERR, DEUTZ, VOLVO, MERCEDES-BENZ, FORD:** CAMINHAO

SÉRIE 21, CASE: IH 82035765, IVECO: 9971889, RENAULT: 5001855189, KHD: 1319759 / 1319875

Bosch

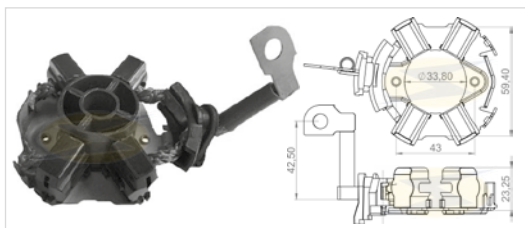

UF - 1240/4 4 escovas / brushes

Especificações / Features: 24V, Tipo / Type: HX87-M - Escova / Brush: 6 x 18 x 14,5 mm

(L x A x C / W x H x L)

Original:

Partida / Starter:

Aplicação / Application: **FORD:** CARGO 2422 / 2626 / 2628 MOTOR CUMMINS ELETRONICO / CUMMINS ELECTRONIC ENGINE

Bosch

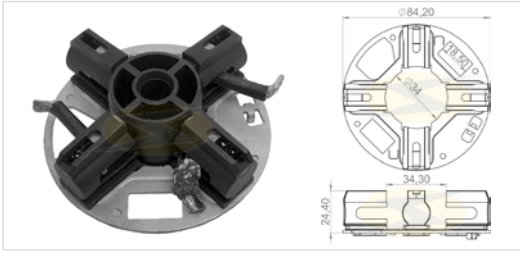

UF - 1.245/4 4 escovas / brushes

Especificações / Features: **24V, Tipo / Type: HX87-M** - 1,5 Kw -

Escova / Brush: 6,1 x 22 x 17,3 mm (L x A x C / W x H x L)

Original: F002G20731

Partida / Starter: F 002 G20 904, BC-4511001-BA

Aplicação / Application: **FORD:** CARGO 816 / 1119 / 1319 / 1519 / 1719 / 1729 / 1723 / 2423 / 2429 / 2623 / 2629 / 1317 / 1517 / 1717 / 1722 / 2422 / 2626 / 2628 / 2622 / 2626, **MOTOR CUMMINS** ELETRÔNICO 24V MOTOR ISC 4.5L E 6.7L (2010→)

Bosch

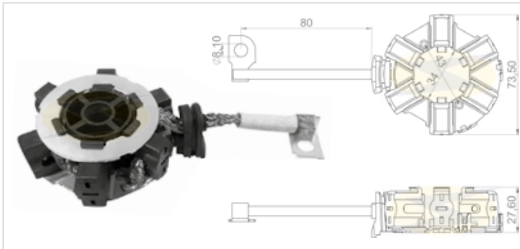

UF - 1.251/6 6 escovas / brushes

Especificações / Features: **12V, Tipo / Type: START/STOP** - Escova / Brush: 5,5 x 18 x 14,5 mm

(L x A x C / W x H x L)

Original: 1004336674, 1004336695, 1004337153 FIAT 77365121

Partida / Starter: 0001136002, 0001136003, 0001137001, 0001137002, 0001137003, 0001137004, 0001137005, 0001137006, 0001137011, 0001137012, 0001138001, 0001138002, 0001138009, 0001138010, 0001138017, 0001138018, 0001138019, 0001138020, 0001138043, 0001138044, 0001138045, 0001138046, 0001138051, 0001138052, 12417550975, 12417567788, 12417589350, 12417589352, 12417589354, 12417589355, 12417589356, 12417610342, 12417610349, 12417550975, 12417567788, 12417589350, 12417589352, 12417589354, 12417589355, 12417589356, 12417610342, 12417610349, 36100-28301, 36100-2B300, 55572440, 06E911021D, 06E911021DX

Aplicação / Application: **AUDI:** A3, A4, A5, A5 3.2 TSI, A6, A7, A7 3.0 TFSI, Q5. **BMW:** 116i, 118i, 120i, 125i, 220i, 228i, 316i, 318i, 320i, 328i,

335i, 420i, 428i, 435i, 520, 528i, 640i, X1, X3, Z4, **CHEVROLET-GM:** AVEO, CRUZE, ORLANDO, TRAXAWD, **CITROËN:** BERLINGO, C3 PICASSO, C4, C4 PICASSO, C4 GRAND PICASSO, C5, C5 BREAK, DS3, **HYUNDAI:** I20, I30, I30CW, I40, IX20, IX 35, VELOSTER, **KIA:** CEE'D, RIO, SOUL, SPORTAGE, VENZA, **MINI:** COOPER, COOPER S, JOHN COOPER WORKS, ONE, **MINI CLUBMAN:** COOPER, COOPER S, ONE, **MINI CLUBVAN:** COOPER, ONE, **MINI COUNTRYMAN:** COOPER, COOPER S, COOPER S ALL4 / JCW, **OPEL:** ADAM, ASTRA J, CASCADA, CORSA, INSIGNIA, MERIVA, MOKKA 4X4, MOKKA TURBO, ZAFIRA, **PEUGEOT:** 207, 207 CC / SW, 308, 308 CC / SW, 3008, **VOLKSWAGEN:** FUSCA TSI, GOLF TSI, GOLF GTI, EOS, PASSAT CC

Delco

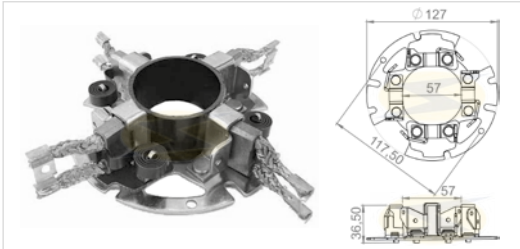

UF - 1.120

UF - 1.120/4 4 escovas / brushes

Especificações / Features: **12V, Tipo / Type: 37/41 MT** - Escova / Brush: 9,6 x 28,6 x 26,6 mm

(L x A x C / W x H x L)

Original: 10468705

Partida / Starter: 1993874, 1993931, 1993963, 1993964

Aplicação / Application: **CHEVROLET-GM:** CAMINHÕES C / MOTOR CATERPILLAR / TRUCKS W / CATERPILLAR ENGINE 3116 / 3126, **CUMMINS:** VEÍCULOS C / MOTOR CUMMINS / VEHICLES W / CUMMINS ENGINE SÉRIE C, **FORD:** VEÍCULOS C / MOTOR CUMMINS / VEHICLES W / CUMMINS ENGINE SÉRIE C, **VOLKSWAGEN:** VEÍCULOS C / MOTOR CUMMINS / VEHICLES W / CUMMINS ENGINE SÉRIE C

Delco

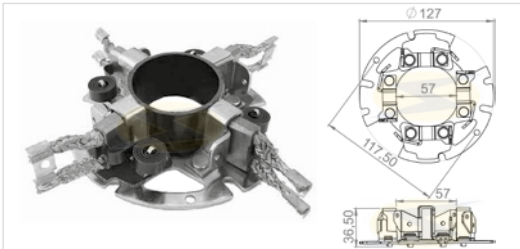

UF - 1.121/4 4 escovas / brushes

Especificações / Features: **24V, Tipo / Type: 37 MT** - Escova / Brush: 9,6 x 28,6 x 26,6 mm

(L x A x C / W x H x L)

Original: 10469238

Partida / Starter: 10479196, 1993910, 10478961, 10479292, 10479310

Aplicação / Application: **CUMMINS:** VEÍCULOS C / MOTOR CUMMINS / VEHICLES W / CUMMINS ENGINE SÉRIE C, **FORD:** VEÍCULOS C / MOTOR CUMMINS / VEHICLES W / CUMMINS ENGINE SÉRIE C, **MERCEDES-BENZ:** 1631L / 1632L / 1632LS / 1634LS / 1938LS / 1939S / 1944L / 2638 / 2638LK / 2638LS / OF1722 / OH1628 / BR 400 / BR 450, ÔNIBUS O-400, CAMINHÕES 1938 / 2638, VEÍCULOS C / MOTOR CUMMINS / VEHICLES W / CUMMINS ENGINE SÉRIE C, **VOLKSWAGEN:** VEÍCULOS C / MOTOR / VEHICLES W / ENGINE SÉRIE C

Delco

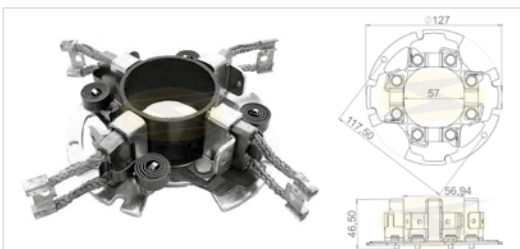

UF - 1.122

UF - 1.122/4 4 escovas / brushes

Especificações / Features: **12V, Tipo / Type: 42 MT** - Escova / Brush: 10,6 x 36,6 x 25 mm

(L x A x C / W x H x L)

Original: 1988121

Partida / Starter: 10479117, 1990420, 1993961

Aplicação / Application: **CUMMINS:** MOTORES / ENGINES CUMMINS, **INTERNATIONAL / NAVISTAR:** NAVISTAR 9000 - CAMINHÕES / TRUCKS 9200, CAMINHÕES / TRUCKS 9200 - 4X2, 9200 - 6X4

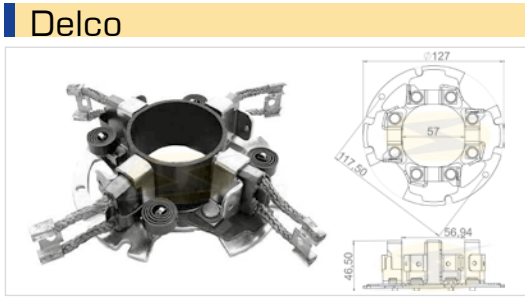

UF - 1.123/4 4 escovas / brushes
Especificações / Features: **24V, Tipo / Type: 42 MT** - Escova / Brush: 10,6 x 36,6 x 25 mm
 (L x A x C / W x H x L)
Original: 1988439

Partida / Starter: 10479114, 10479118, 1990378, 10478941

Aplicação / Application: **CUMMINS: MOTORES CUMMINS / CUMMINS ENGINE**

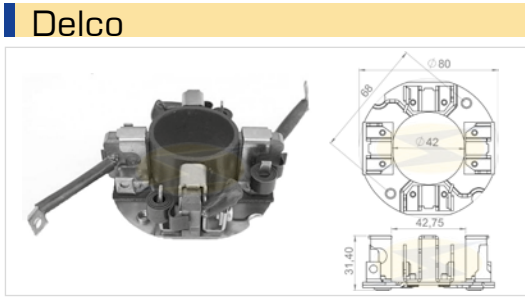

UF - 1.133
UF - 1.133/4 4 escovas / brushes
Especificações / Features: **12V, Tipo / Type: 28 MT** - Escova / Brush: 8 x 25 x 19,5 mm
 (L x A x C / W x H x L)
Original: 10456456

Partida / Starter: 10479621

Aplicação / Application: **ASIA MOTORS: BESTA, CUMMINS: MOTORES CUMMINS / CUMMINS ENGINE, MERCEDES-BENZ: SPRINTER 180 / 7t - 709 / 9t - 912**

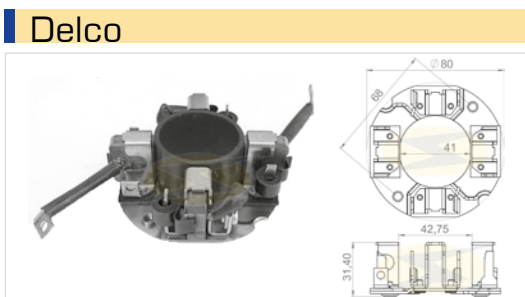

UF - 1.134/4 4 escovas / brushes
Especificações / Features: **24V, Tipo / Type: 28 MT** - Escova / Brush: 8 x 25 x 19,5 mm
 (L x A x C / W x H x L)
Original: 10483823

Partida / Starter: 1113277, 10479626

Aplicação / Application: **ASIA MOTORS: BESTA, CUMMINS: MOTORES CUMMINS / CUMMINS ENGINE, MERCEDES-BENZ: CAMINHÕES E ÔNIBUS 712 / 912 / 914 / 1215 / 1417 / 1625 / 1628 / 1632 / 1721 / 1725 / 2423 C/ MOTOR / W/ ENGINE BR900**

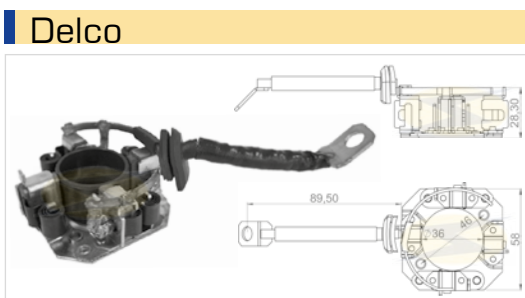

UF - 1.148/4 4 escovas / brushes
Especificações / Features: **12V, Tipo / Type: PG260MQ / PMGR** - Escova / Brush: 6 x 19 x 16 mm
 (L x A x C / W x H x L)
Original: 10475602

Partida / Starter: 9000 786, 9000 798, 9000 804, 9000 805, 9000 806, 9000 812, 9000 819, 9000 820, 9000 821, 9000 822, 9000 827, 9000 834, 9000 835, 9000 844, 9000 850, 9000 851, 9000 853, 9000 860, 9000 861, 9000 862, 9000 863, 9000 864, 9000 866, 9000 867, 9000 899, 9000 900

Aplicação / Application: **CHEVROLET-GM: BLAZER / S10 - C/ MOTOR / W/ MOTOR VORTEC V6 4.3L, CASE: MINI TRATOR / TRACTOR**

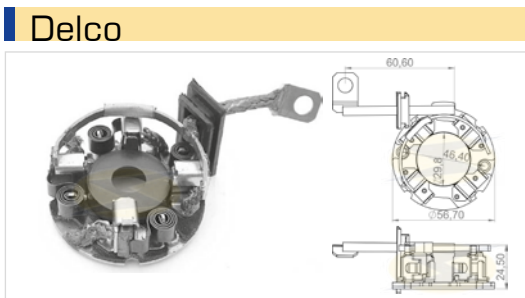

UF - 1.149/4 4 escovas / brushes
Especificações / Features: **12V, Tipo / Type: PG260B / C / D** - Escova / Brush: 5 x 15 x 13 mm
 (L x A x C / W x H x L)
Original: 10452368, 10504488, DELCO: 10535653

Partida / Starter: 8000090, 8000158, 8000159, 8000188, 9000844, 9000893, 9000948, 9000978, 9000981

Aplicação / Application: **CHEVROLET-GM: MONZA, ASTRA, BLAZER, CELTA, CORSA, CORSA CLASSIC, MERIVA, MONTANA, PICK-UP CORSA, S-10, VECTRA - TODOS COM / ALL WITH DOHC / SOHC II, C/ MOTORES / W/ MOTORS 1.8, 2.0 / 2.2 L 16V / L 8V, ZAFIRA - COM MOTOR / WITH MOTOR 1.8 / 2.0 / 2.2 E 2.4 8V E 16V SOCH (GASOLINA, ÁLCOOL E FLEX), FIAT: PALIO, PALIO WEEKEND, SIENA, DOBLÔ, STILO, STRADA, UNO, PUNTO E IDEA (TODOS COM MOTORES FIRE / ALL WITH FIAT FIRE ENGINE 1.0 / 1.3 / 1.4 / 1.8, 8V E 16V), DAEWOO - ESPERO 2.0 L., OPTRA 1.8 L (GASOLINA, ÁLCOOL E FLEX), OPTRA 1.4L., CADILLAC, ISUZU, OLDSMOBILE, KADET**

Delco



UF - 1.167

UF - 1.167/12 12 escovas / brushes

Especificações / Features: **24V, Tipo / Type:** 50MT - Escova / Brush: 8 x 19 x 19 mm

(L x A x C / W x H x L) - 12 Escovas / Brushes RX 92 ou / or RX 124

Original: 1945849, 1967354

Partida / Starter: 10478827, 10478829

Aplicação / Application: LOCOMOTIVA COM MOTORES / Locomotive for engines DIESEL V16 E V20, **CATERPILLAR:** 245, 346, 621B, 621E, 623E, 631D, 631E, 633D, 637E, 639D, 641B, 651B, 651E, 657B, 657E, 660B, 666B, 768B, 768C, 769B, 769C, 772, 772B, 773, 773B, 824, 824C, 825C, 826C, 834B, 983B, 988, 988B, 992, 992B, 992C, 3406, 3408, 3412, 3508, 3512, 3516, D343, D08, **CLARK:** 275K, 310, 310III, 310IIIH, 330IIIH, 380, 380III, 380IIIA, 380-2III, 380C-480, 410, 475III, 475B, 675, 675B, **CUMMINS:** SÉRIE K, **INGERSOLL RAND:** DL 1200

Delco

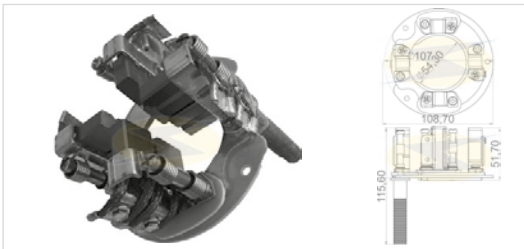

UF - 1.168

UF - 1.168/8 8 escovas / brushes

Especificações / Features: **24V, Tipo / Type:** 40MT - Escova / Brush: 9,5 x 19 x 19 mm

(L x A x C / W x H x L) - 8 Escovas / Brushes RX70

Original: 1948515

Partida / Starter: _____

Aplicação / Application: **CATERPILLAR, FIAT-ALLIS, JOHN DEERE**

Delco



UF - 1.181/4

4 escovas / brushes

Especificações / Features: **12V, Tipo / Type:** 39MT - Giro Sentido Horário / Clockwise Rotation - Escova / Brush: 9,5 x 32 x 22 mm (L x A x C / W x H x L)

Original: _____

Partida / Starter: 8200288, 8200289, 8200290, 8200291, 8200308, 8200417, 8200468, 8200469, 8200470, 19011513, 19011519

Aplicação / Application: **FREIGHTLINER:** C/ MOTOR CAT C10 / C12 / C15, C11 / C13 / C15, ACERT, **VOLVO:** MOTOR D11 / 12 / 13 / 16, **CUMMINS:** 3103915, ISX, ISM, N14 OU DDC 60 SERIES, **MACK:** C/ MOTOR E-7, MP7 / 8, **INTERNACIONAL:** MAXXFORCE 11, 13

Delco



UF - 1.182/4

4 escovas / brushes

Especificações / Features: **24V, Tipo / Type:** 39MT - Giro Sentido Horário / Clockwise Rotation - Escova / Brush: 9,5 x 32 x 22 mm (L x A x C / W x H x L)

Original: 10527543

Partida / Starter: 19011507, 19011509, 19011511, 19011522, 19011523, 19011524, 19011527, 8200034, 8200039, 8200101, 8200040, 8200465, 8200519

Aplicação / Application: **CNH:** COLHEITADEIRA DE CANA A7000 E A7700 COM MOTOR CUMMINS / SUGAR CANE LOADER A700 AND A7700 WITH CUMMINS ENGINE, **FIAT:** ALLIS MAT TRACTOR FC170, ALLIS GRADER FG170 / 170.2 / 200 E 200.2, **TEREX:** EMPILHADEIRA / FORKLIFT GEP 23, **CUMMINS:** 3102920 E 3103914.

Delco

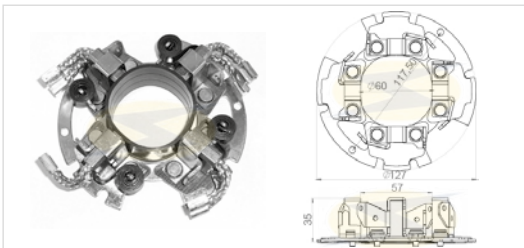

UF - 1.184

UF - 1.184/4 4 escovas / brushes

Especificações / Features: **12V, Tipo / Type:** 41MT - Escova / Brush: 9,6 x 28,6 x 26,6 mm

(L x A x C / W x H x L), (Quatro pólos isolados / Four isolated poles)

Original: 10468705

Partida / Starter: 10479109

Aplicação / Application: **AGCO, MASSEY-FERGUSON:** TRACTOR 2360 COM MOTOR CUMMINS / WITH CUMMINS ENGINE. **CATERPILLAR:** COLHEITADEIRA / COMBINE MT875

Delco

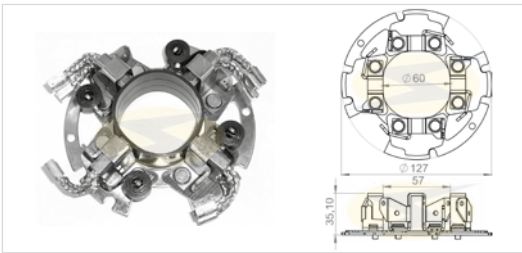

UF - 1.185/4 4 escovas / brushes

Especificações / Features: **24V, Tipo / Type: 41MT** - Escova / Brush: 9,6 x 28,6 x 26,6 mm

(L x A x C / W x H x L) - (Quatro pólos isolados / Four isolated poles)

Original: 10470208, 10453807, 10500113

Partida / Starter: 10478898

Aplicação / Application: **PLATAFORMA / PLATFORMS 0400 RSD E SRE (2004→2009)**

Delco

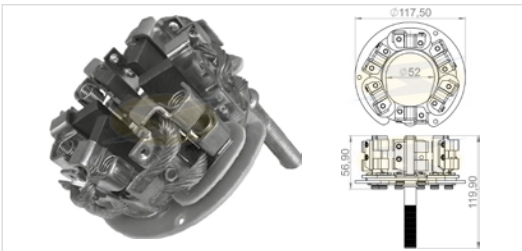

UF - 1.188
UF - 1.188/6 6 escovas / brushes

Especificações / Features: **24V, Tipo / Type: 50MT** - Escova / Brush: 8 x 38 x 21,5 mm

(L x A x C / W x H x L) - 6 ESCOVASRX 124H

Original: 1984974

Partida / Starter: 9000794, 9000871

Aplicação / Application: **CATERPILLAR:** 245, 346, 621B, 621E, 623E, 631D / E, 633D, 637E, 639D, 641B, 651B / E, 657B / E, 660B, 666B, 768B / C, 769B / C, 769C, 772 / B, 773 / B, 824 / C, 825C, 826C, 834B, 983B, 988 / B, 992 / B / C, 3406 / 08 / 12, 3508 / 12, 3516, 4D343, D08, **CLARK:** 275K, 380, 475B, 675B, 310, 310III, 310IIIH, 330IIIH, 380, 380III, 380IIIA, 380-2III, 380C-480, 410, 475III, 475B, 675, 675B, **CUMMINS:** SÉRIE K, **INGERSOLL RAND:** DL 1200

Delco

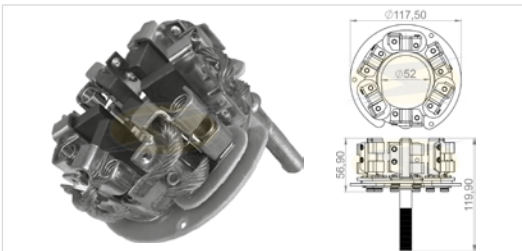

UF - 1.189/6 6 escovas / brushes

Especificações / Features: **12V, Tipo / Type: 50MT** - Escova / Brush: 8 x 38 x 21,5 mm

(L x A x C / W x H x L)

Original:

Partida / Starter: 10461056, 10461129, 10461191, 10461731, 10461738, 10461741, 10478813, 10478877, 10478881, 10478906, 10478910, 10478917, 10479201, 10479297, 10479309, 10479328, 10479336, 10479338, 10479341, 10479352, 10479382, 1109554, 1990261, 1990277, 1993859

Aplicação / Application: **CUMMINS, CHEVROLET / GMC HEAVY DUTY, FORD HEAVY DUTY, FREIGHTLINER, KENWORTH, PETERBILT, VOLVO, WESTERN STAR**

Delco

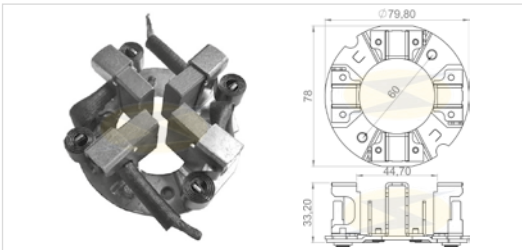

UF - 1.190/4 4 escovas / brushes

Especificações / Features: **24V, Tipo / Type: 38MT**, 6,0 Kw - Escova / Brush: 9,5 x 28 x 22 mm

(L x A x C / W x H x L)

Original: 10528064

Partida / Starter: 8200053, 8200072, 8200078

Aplicação / Application: **VOLKSWAGEN:** 31.370, 25.370, 19.370 COM MOTOR 9,3 LITROS INTERNATIONAL / VWB - 18.310, 19.320, 31.320 - TITAN TACTOR E CONSTELLATION C/ MOTOR / W/ ENGINE CUMMINS ISC 8,3 LITROS, ÔNIBUS / BUS 19320EOT - QUÉOPS EVOLUTION COM MOTOR / W/ ENGINE CUMMINS ISC 8,3 LITROS, 17-320 E, 18-320 EVO, 19-360 E, 24-320E, 25-320E, 25-370E, 25-400E - TODOS COM MOTOR CUMMINS / ALL W/ CUMMINS ENGINE, **FORD:** CARGO ELETRÔNICO - 2632, 2932, 4532 E 5032

Delco

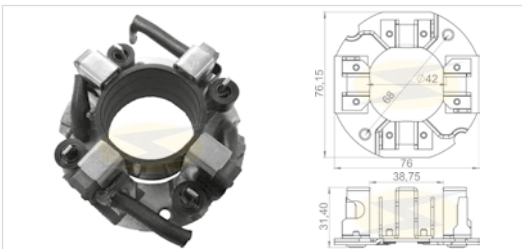

UF - 1.191
UF - 1.191/2 2 escovas / brushes
UF - 1.191/4 4 escovas / brushes

Especificações / Features: **12V, Tipo / Type: 29MT**, 3,3 Kw - Escova / Brush: 8 x 25 x 18 mm

(L x A x C / W x H x L)

Original: 10527547

Partida / Starter: 820003, 820295, 820196, 820331, 820478

Aplicação / Application: **MB:** CAMINHÕES / TRUCKS 710, 712E, 1418R, 1720, 1720K, L1620 - CHASSI DE ÔNIBUS / BUS FRAME LO 712, LO 812, LO 814 (TODOS C/ MOTORES MECÂNICOS / ALL W/ MECHANIC ENGINE 12V OM 364 E OM 366), VWB, CAMINHÕES / TRUCKS WORKER, 8-120 EURO II E III, 13-180 EURO II E III, 15-180 EURO III, 17-180 EURO III. (MOTOR / ENGINE MWM 4 E 6 CILINDROS) ÔNIBUS / BUS 8.120 OD EURO II E III (MOTOR / ENGINE MWM 4 CILINDROS), **VOLKSWAGEN:** 8-120, 9-150, 13-180, 17-180, 8-150, COM MOTOR / W/ ENGINE MWM, 4 E 6 CILINDROS MECÂNICO, CAMINHÕES / TRUCKS 8-150, 15-190, 17-250, 24-250 COM MOTOR / W/ ENGINE CUMMINS ISB 4 E 6

CILINDROS COM CREMALHEIRA 10/12 (→2009), **FORD:** CAMINHÕES / TRUCKS C815E (4X2), C1317E (4X2), C1517E (4X2), C1717E (4X2), C1722E (4X2), C2422E (6X2), C2622E (6X4), C2428E (6X2), C2628E (6X4), COM MOTOR / W/ ENGINE CUMMINS EIETRÔNICO ISB (4 E 6 CILINDROS)

Delco

UF - 1.192/2 2 escovas / brushes
UF - 1.192/4 4 escovas / brushes

Especificações / Features: 24V, Tipo / Type: 29MT, 4.0 Kw - Escova / Brush: 8 x 25 x 18 mm

(L x A x C / W x H x L)

Original: 10527548

Partida / Starter: 8200004, 8200064, 8200138, 8200296, 8200297, 8200054, 8200231, 8200292, 8200357, 8200386

Aplicação / Application: **MB:** CAMINHÕES / TRUCKS 1720A - CHASSI DE ÔNIBUS OF 1721, OH 1420, OH 1621L, OH 1623 (MOTORES MECÂNICOS / MECHANIC ENGINES 24V OM 364 E OM 366), GRADER 845, 845.2, FG 140.2, PÁ CARREGADEIRA W20, 521D, 621D, W130, MOTONIVELADORAS RG140.B, RG170.B (MOTORES / ENGINES CUMMINS B 4 E 6 CC), 712C, 715, 714C, 915C, 1215, 1218EL, 1218L, 1418 EL, 1418L, 1718, 1725, 2423, 2428, FAMÍLIA ATEGO (1315, 1418, 1518, 1718, 1725, 2425), L1318, 2423B, 2423K, L1620 CHASSI DE ÔNIBUS / BUS FRAME LO 914, 0500M / U / R, OF 1417 / 1418 / 1518 / 1721 / 1722 (MOTORES ELETRÔNICOS / ELECTRONIC ENGINES 24V OM 904

/ 906 / 924 / 926), AXOR 1933 CAMINHÕES / TRUCKS 8-150 ELETR DELIVERY PULS, 9-150E, 10-150E, 13-180E, 15-190E (→06.2009), 17-250E, 24-250E (→09.2009) - MOTOR CUMMINS ISB 4 E 6 CIL. ÔNIBUS 8-150 ODC / FEB, 9-150 ODC - MOTOR / ENGINE CUMMINS ISB 4 E 6 CIL., **VOLKSWAGEN:** CONSTELLATION 13-180, 15-180, 17-260, 26-260E, 31-260E (MOTOR / ENGINE MWM ELETRÔNICO 4 E 6CC) ÔNIBUS / BUS 8-150ODM / ODM ELTR. / ODM DELIVERY, 9-150EOD, 15-190EOD, 17-210EOD, 17-230EOD / UTRONIC E 17-260EOD / UTRONIC (MOTOR / ENGINE MWM ELETRÔNICO 4 E 6 CC), 8-150 ELETR DELIVERY PULS, 9-150E, 10-150E, 13-180E, 15-190E (06.2009→), 17-250E, 24-250E (10.2009→) - TODOS COM MOTOR CUMMINS ISB 4 E 6 CIL. ÔNIBUS 8-150 ODC / FEB, 9-150 ODC - TODOS COM MOTOR CUMMINS ISB 4 E 6 CIL. CAMINHÕES 9-150 ELETR DELIVERY MOTOR CUMMINS (01.2010 →), **VOLVO:** CAMINHÕES VM 210, 260, 310 COM MOTORES MWM 4.12TCE E 6.12TCE (SUBSTITUI MELCO), **CASE:** MOTONIVELADORA RG140B E 845 COM TRANSMISSÃO ZF

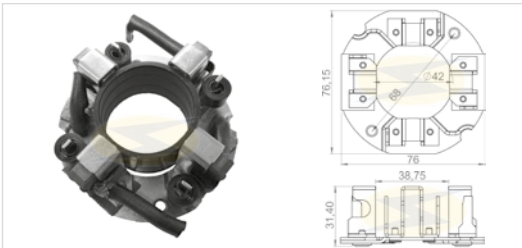

Delco

UF - 1.193/4 4 escovas / brushes

Especificações / Features: 12V, Tipo / Type: PG260G - Escova / Brush: 5 x 16 x 12,5 mm

(L x A x C / W x H x L)

Original: 10453748

Partida / Starter: 9000871, 9000846, 9000794

Aplicação / Application: **CHEVROLET-GM:** S-10 4CC 2.2, ASTRA, VECTRA CD 2000 (OPEL), ZAFIRA (OPEL), **DAEWOO:** CIELO, ESPERO CD 2000, RACER, LANOS, LEGANZA, NEXIA, NUBIRA

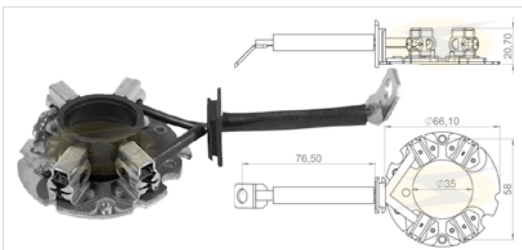

Delco

UF - 1.220
UF - 1.220/4 4 escovas / brushes

Especificações / Features: 12V, Tipo / Type: 40MT - Escova / Brush: 9,5 x 38 x 19,5 mm

(L x A x C / W x H x L)

Original:

Partida / Starter: 1945960, 1948518, 1949611, 1967552, 1967553, 1979185, 1979387, 1979494, 1979502 (DD Séries)

Aplicação / Application: **CATERPILLAR**



Delco

UF - 1.221

Especificações / Features: 12V, Tipo / Type: 8/ 10/ 15/ 20/ 25/ 27, 30 MT, SD 300, Conjunto

reparo pólo positivo / Positive Repair Set

Original:

Partida / Starter: 7322 463 48

Aplicação / Application: **CHEVROLET-GM:** OPALA, CARAVAN 2500 4CC / 4100 6CC (1969→1984), C-10, C-14, C-60 (GAS), **ALLIS CHAR-MES, CADILLAC:** (1957→1963), **HYSTER, FORD:** (1963→1964), **AMC:** (1959→1963), **BUICK:** (1957→1963), **CHECKER CAB:** (1964→1980), **CHEVY/GMC:** Trucks (1955→1978), **INTERNACIONAL TRUCKS:** (1957→1979), **JEEP:** (1961→1971), **OLDSMOBILE:** (1957→1974), **PONTIAC:** (1956→ 1974), **STUDEBAKER:** (1965→1966), **APLICAÇÕES MARÍTIMAS/ MARINE APPLICATION:** **CHRIS CRAFT:** (1967→1978), **CRUSADER:** (1961→1975), **GRAY MARINE:** (1957→1967), **JOHNSON-EVINRUDE:** (1967→1978), **MERCURY:**

(1971→1978), **PALMER:** (1955→1963), **UNIVERSAL:** (1961→1964)

Delco

UF - 1.228/4 4 escovas / brushes

Especificações / Features: 12V, Tipo / Type: PG260F2 - 1,5 Kw - Escova / Brush: 5 x 18 x 15 mm

(L x A x C / W x H x L)

Original:

Partida / Starter: 9000836, 9000837, 9000841, 9000842, 9000854, 9000857, 9000858, 9000888

Aplicação / Application: **BUICK:** LESABRE 3.8L (1997→2003), PARK AVENEU 3.8L (1998→2001), REGAL 3.8L (1998→2001), **CHEVROLET GM:** BLAZER / S-10 4.3L V6 VORTEC, CAMARO 3.8L (1998→2000), IMPALA (2000), LUMINA 3.8L (1998→1999), MONTE CARLO 3.8L (1998→2000), SILVERADO 4.8L, 5.3L, SUBURBAN SIERRA / YUKON XL 4.8 / 5.3L, TAHOE YUKON 4.8 / 5.3L, G1500, G2500 4.3L V6, S. T SERIES 4.3L V6, **GMC:** JIMMY, SAFARI, SIERRA 4.3L V6, **SONOMA ISUZU:** HOMBRE 4.3L V6, **OLDSMOBILE:** BRAVADA 4.3L V6, 88 3.8L (1998→1999), INTRIGUE 3.8L (1998→1999), **PONTIAC:** FIREBIRD 3.8L (1998→2001), GRAND PRIX 3.8L (1997→2000), **CADILLAC,**

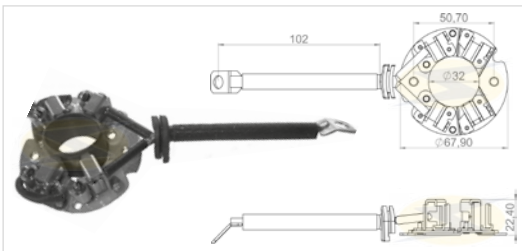

Delco

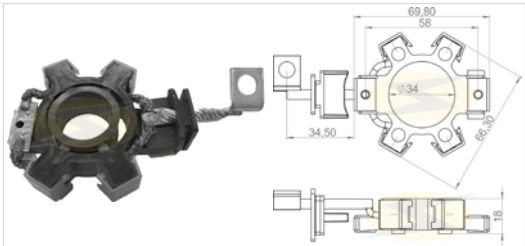

UF - 1.230/4

4 escovas / brushes

Especificações / Features: **12V, Tipo / Type: SD80** - Escova / Brush: 5 x 13 x 16 mm

(L x A x C / W x H x L)

Original: 10475107, 93740997

Partida / Starter: 10455503, 10455506, 10455515, 96275471, 96467385

Aplicação / Application: **CHEVROLET-GM:** AVEO 1.6L, MATIZ, NUBIRA (1997→2003), **DAEWOO:** CIELO, MATIZ, TICO, REZZO, **NISSAN:** SENTRA 1.6 / 1.8 / 2.0, **SUZUKI:** WAGON R+ 1.2 4WDM, SWIFT 1.6L, **PONTIAC:** WAVE 1.6L

Delco

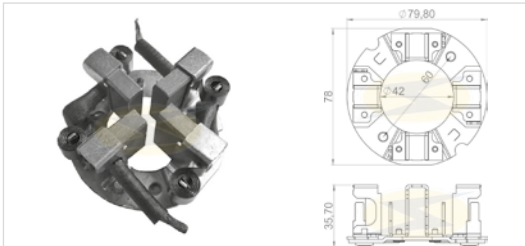

UF - 1.241/4

4 escovas / brushes

Especificações / Features: **12V, Tipo / Type: 38MT** - Escova / Brush: 9,5 x 28 x 22 mm

(L x A x C / W x H x L)

Original: 10528064

Partida / Starter: 10461768, 10461769, 10461775, 19026027, 19026028, 19026029, 19026031, 19026035, 8200005, 8200007, 8200023, 8200025, 8200075, 8200076, 8200077, 8200211, 8200217, 8200235, 8200239, 8200324, 8200408, 8200977, 8201002, 8201039, 8300005, 8300021, 8300022, 8300024, 8300026, 8300065, 8300066

Aplicação / Application: **FORD:** CARGO MOTOR CUMMINS ELETRONICO, **FREIGHTLINER:** CENTURY COM MOTOR MBE4000, **CASCA-DIA:** COM MOTOR MBE4000, MOTOR MBE 4000

Denso

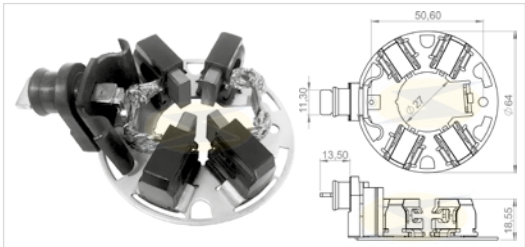

UF - 1.249/4

4 escovas / brushes

Especificações / Features: **12V, Tipo / Type: PMGR** - Escova / Brush: 4,5 x 12 x 12,3 mm

(L x A x C / W x H x L)

Original:

Partida / Starter: BC 428000-9391, BC 438000-9500, 51911199, 80023936

Aplicação / Application: **FIAT GRAND SIENA, SIENA**

Denso

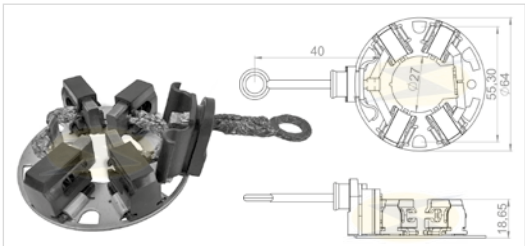

UF - 1.250/4

4 escovas / brushes

Especificações / Features: **12V, Tipo / Type: PMGR** - Escova / Brush: 4,5 x 12 x 12,3 mm

(L x A x C / W x H x L)

Original:

Partida / Starter: BC 438000-0920, 02M911021F

Aplicação / Application: **VOLKSWAGEN:** GOL 2013, VOYAGE 2013 EM DIANTE, UPI 2013 EM DIANTE

Ford / Motorcraft

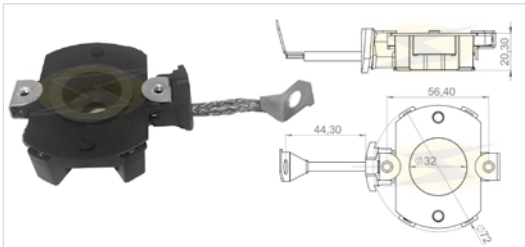

UF - 1.108/4

4 escovas / brushes

Especificações / Features: **12V** - Escova / Brush: 4,6 x 16 x 14 mm (L x A x C / W x H x L)

Original: F3RZ11002C, F3RZ11061A, F3RZ11061C

Partida / Starter: F77211002AA, 93BB11000

Aplicação / Application: **FORD:** BRONCO, ECOSPORT, EXPEDITION, EXPEDITION 6CL, EXPLORER 4.0 L V6, MONDEO, MUSTANG V6, RANGER, WINDSTAR V6

Ford / Motorcraft

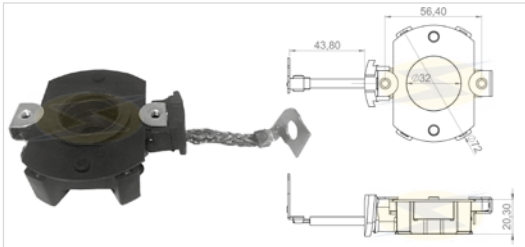

UF - 1.109/4

4 escovas / brushes

Especificações / Features: **12V** - Escova / Brush: 4,6 x 16 x 14 mm (L x A x C / W x H x L)

Original: E90Z11061A, E90Z11061B, E90Z11061C

Partida / Starter: SB-33, SB-335, SB-337, SB-348, SB-353, SB-356, E90F11000AA, E90F11000BA, E95F11000AA, E95F11000BA, F02F1 10 00AA, F07U11000AA, F07U11000BA, F0CF11000AA, F0CF11000BA, F00U11000AA, F13U11000AA

Aplicação / Application: **FORD:** CONTOUR-4 / 6CL, COURIER, ESCORT 4CL, FIESTA, KA, MERCURE SABLE 6CL 3.0L, MONDEO, VAN WINDSTAR 6CL

Ford / Motorcraft

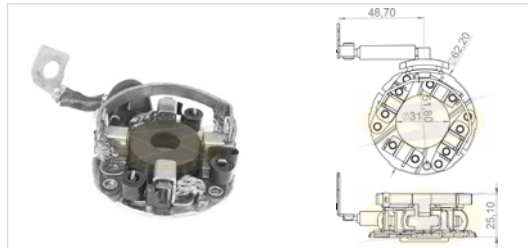

UF - 1.137/4 4 escovas / brushes

Especificações / Features: **12V, Tipo / Type: PMGR** - Escova / Brush: 6 x 12,7 x 13,35 mm

(L x A x C / W x H x L)

Original:

Partida / Starter: 96BB11000AA7, 19 BI, 96FB11000MG

Aplicação / Application: **FORD:** MONDEO, KA, ESCORT, FIESTA, CONTOUR LX / SE / SPORT, FOCUS LE / LX / S2 / SE / STREET / SVT / ZTS / ZTW / ZX5, **MERCURY:** COUGAR, MYSTIQUE GL / LS

Ford / Motorcraft

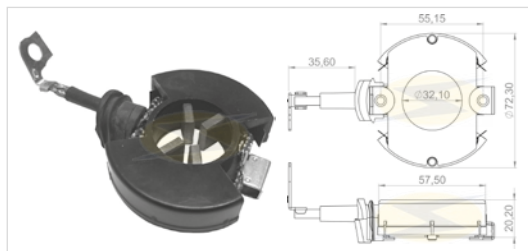

UF - 1.176/4 4 escovas / brushes

Especificações / Features: **12V, Tipo / Type: PMGR** - Escova / Brush: 4,5 x 16 x 16,2 mm

(L x A x C / W x H x L)

Original: F81U11434AA

Partida / Starter: F81Z11002AA, XL1Z11002AA, XW4U11000CG, XW4Z11002CG

Aplicação / Application: **FORD:** COURIER, RANGER, F-150, 4.6L / 5.4L V8 (1999→2001), 6.8L V10, F-100, EXPLORER, TRANSIT, 4.6L V8 (1999→2001), 5.4L V8 (2000→2001), 6.8L V10 (2000→2001), EXCURSION, EXPEDITION, THUNDER BIRD, **LINCOLN:** BLACKWOOD, NAVIGATOR

Ford / Motorcraft

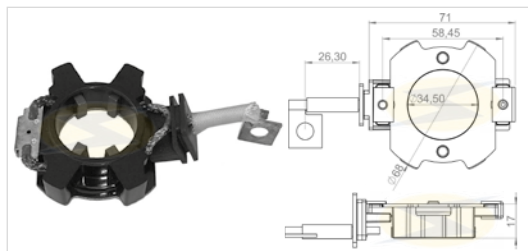

UF - 1.177/4 4 escovas / brushes

Especificações / Features: **12V, Tipo / Type: PMGR** - Escova / Brush: 4,8 x 13 x 12 mm

(L x A x C / W x H x L)

Original:

Partida / Starter: 10455505, **DAEWOO:** AA10018400

Aplicação / Application: **DAEWOO:** TOWNER, **FORD EURO**

Ford / Motorcraft

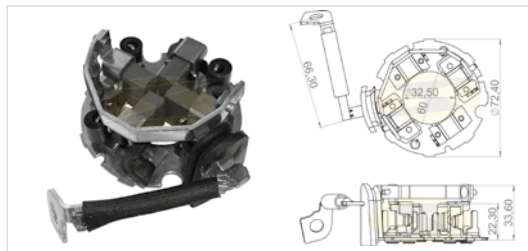

UF - 1.183/4 4 escovas / brushes

Especificações / Features: **12V** - Escova / Brush: 8,2 x 19,2 x 22,3 mm (L x A x C / W x H x L)

Original: F7RU11434BA, F7RUBA

Partida / Starter: 4878768, 93BB11000JB, 97BB11000BB, 97BB11000BC, 97CA11000AB, 97VB11000A, 97VB11000AA, 97VB11000AB, 97VB11000B, 97VB11000BA, 98AB11000AC, 98AB11000BC, 98VB11000B1A, 98VB11000B3A, 98VB11000BA, F3RZ11002A, F3RZ11002B, F3RZ11002C, F50Y11002A, F87U11000, YC1U11000AB

Aplicação / Application: **FORD:** F-100, F-1000, COURIER, RANGER DIESEL, TRANSIT, FIESTA, FOCUS, MONDEO, ESCORT, ORION

Hitachi / Mitsubishi

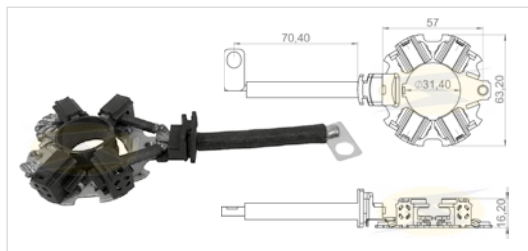

UF - 1.180/4 4 escovas / brushes

Especificações / Features: **12V** - Escova / Brush: 4,5 x 12 x 12,2 mm (L x A x C / W x H x L)

Original:

Partida / Starter:

Aplicação / Application: **CHRYSLER, DODGE, HYSTER:** EMPILHADEIRA / FORKLIFT, **MITSUBISHI, NISSAN:** SENTRA, VEÍCULOS COM MOTORES / VEHICLES WITH ENGINE GA15, **RENAULT**

Hitachi / Denso

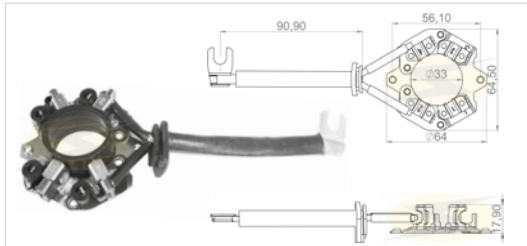

UF - 1.205/4 4 escovas / brushes

Especificações / Features: **12V, Tipo / Type: PMGR** - Escova / Brush: 4,5 x 14 x 17 mm
(L x A x C / W x H x L)

Original:

Partida / Starter: S114-753C, S114-755, S114-756, S114-766A, S114-767, **DENSO:** 752 1122-03, **DENSO:** 428000-7400, **CHRYSLER:** 04801694AC

Aplicação / Application: **ACURA, JEEP:** GRAND CHEROKEE LAREDO (2010→2012), **ISUZU, BMW:** 335, **NISSAN:** SENTRA

Hitachi

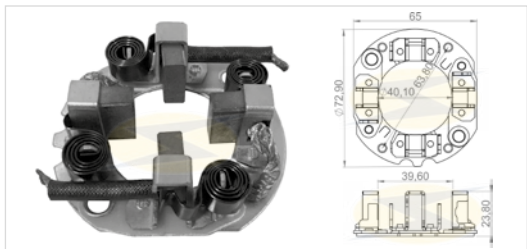

UF - 1.214/4 4 escovas / brushes

Especificações / Features: **12V, Tipo / Type: OSGR** - Escova / Brush: 7 x 19 x 15,2 mm
(L x A x C / W x H x L)

Original: 2130-13022, 21301306, 213053021, 213053022, 213073021, 213073022, 213093021,

21309305, 22401310, 22402310, EC45011

Partida / Starter: 2,3 KW 12V, RFB S114482, RFB S131068, S13-91, S13-91A, S13-114, S13-102, S13-102A, S13-105, S13-107, S13-121, S13-137A, S13-200, S13-203, S13-210B, S13-210C, S13-282, S13-289, S13-289A, S13-294, S13-302, S13-302A, S13-305, S13-307A, S13-317, S13-321, S13-322, S13-326, S13-327, S13-329, S13-331, S14-203, S14-205, S14-206, S14-210, S14-210A, 2130-61004, 2130-81004, 23310-0Y000, 2330010T02

Aplicação / Application: **ISUZU:** 8.94478-863-0, **KOMATSU:** EMPILHADEIRA/ FORKLIFT FG40, **NISSAN:** EMPILHADEIRA/ FORKLIFT, (PARTI-

-DAS RFB S114482), **CAPISTAR** 2.3D / 2.3 TD / 2.5 TD / 2.7 TD, **KING VAN** 2.3 D / 2.5 D, **URVAN** 2.0 / 2.3 TD / TD27, **TERRANO** 2.7 TD, **PICK UP D.** (PARTIDAS RFB S131068), **GMC:** 7.110, **THERMO KING**

Hitachi

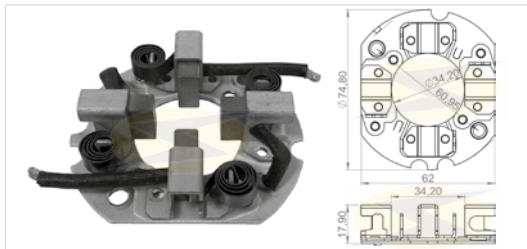

UF - 1.215/4 4 escovas / brushes

Especificações / Features: **12V, Tipo / Type: G/R** 1,4 Kw - Escova / Brush: 6,8 x 14 x 15 mm
(L x A x C / W x H x L)

Original: 2114-79001, 23378 M4901

Partida / Starter: S114-252, S114-253, S114-254, S114-255, S114-257, S114-258, S114-264, S114-296, S114-322, S114-344, S114-357, S114-393, S114-429, S114-458

Aplicação / Application: **NISSAN:** CD17, **ISUZU, MASSEY-FERGUSON, TOYOTA, YANMAR**

Iskra

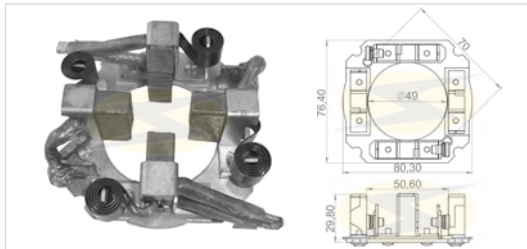

UF - 1.213/4 4 escovas / brushes

Especificações / Features: **12V, Escova / Brush:** 10 x 25 x 23 mm (L x A x C / W x H x L)

Original: 16906708

Partida / Starter: AZJ 3313 K4W Z9, 11.130.664, 11.130.679, 11.130.695, 11.130.739, AZJ 3216, AZJ 3226, AZJ 3236, AZJ 3261, AZJ 3405, 15.0679, 15.0695, 15.0739, 15.1063

Aplicação / Application: **NEW HOLLAND, VALTRA (VALMET):** TRATORES

Iskra

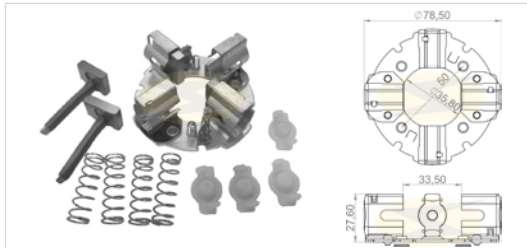

UF - 1.236/4 4 escovas / brushes

Especificações / Features: **12V, Escova / Brush:** 6,3 x 14,9 x 21,8 mm (L x A x C / W x H x L)

Original: 16908752

Partida / Starter: AZE4573, 11.131.223, 11.131.426, 11.131.598, 11.131.599, 11.131.279, 11.131.198, 11.131.535, 11.131.659

Aplicação / Application: **CNH:** TS6000, 6030, 6040, 8030, **CUMMINS:** 4B, 6B, **JOHN DEERE, MWM, MASSEY-FERGUSON, NEW HOLLAND:** TS 6000, 6030, 6040, 8030, **VALTRA:** 685, **YANMAR**

Iskra

UF - 1.237/4 4 escovas / brushes

Especificações / Features: 12V - Escova / Brush: 10 x 25 x 23 mm (L x A x C / W x H x L)

Original: 16908336, 16906265

Partida / Starter: 11.130.567, 11.130.569, 11.130.619, 11.130.627, 11.130.692, 11.130.703, 11.130.704, 11.130.705, 11.130.706, 11.130.762, 11.130.799, 11.130.819, 11.130.820, 11.130.862, 11.130.863, 11.130.998, 11.131.542, 11.131.573, 11.131.430, 131.131.705, 11.131.798, 11.130.941, 11.131.370, 11.131.300, 11.131.508, 11.131.260, 11.131.507, 11.131.491

Aplicação / Application: **AGCO, CASE:** MAGNUN 220, 240, 270, 2388, 2399, **CUMMINS:** 6CC, **MASSEY-FERGUSON:** MF-34 / 275 / 291 / 297 / 298 / 299 / 650 / 660 / 680 / 6350 / 6360 / 7140 / 7150 / 7170 / 7080, **NEW HOLLAND:** TM 7010, 7020, 7030, 7040, TS 6000, 6020, 6030, 6040, TC 57, **COLHEITADEIRA / COMBINE:** CS 660, **PERKINS, VALTRA:** BH- 185I, BH-205I

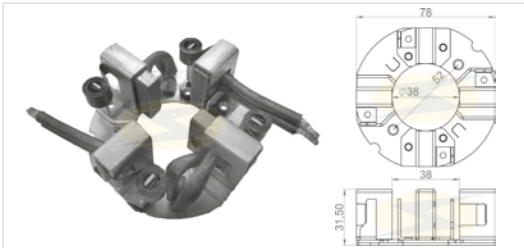

Iskra

UF - 1.243/4 4 escovas / brushes

Especificações / Features: 12V, Tipo / Type: DD (DIRECT DRIVE) - 2,7 Kw -

Escova / Brush: 8,9 x 15,9 x 23 mm (L x A x C / W x H x L)

Original:

Partida / Starter: 16445, 16562, 17072, 17074, 17075, 17095, 17114, 17649, 18461, 19657, 19677, 30036, 30122, 32302, 11.130.823, AZJ3286

Aplicação / Application: **VALTRA:** 685C, 685F (MWM), **AUDI, HANOMAG HENSCHEL, MERCEDES-BENZ, STEYR-DAIMLER-PUCH AG, VOLVO, VOLKSWAGEN, CESAB, GOLDONI, ITMA TRATTORI, JENBACHER WERKE, LAND ROVER, VM, STABILIMENTI MECCANICI, AGRALE-DEUTZ:** 1600D D229-3 3.0. (1985→), 1800D D229-4 3.9L (1988→), TX1600 D229-3 3.0L (1983→1985), **MULLER:** VIBRO RT62 D229-3 2.0L (1981→), RT82 D229-3 2.0L (1981→), **MWM-DIESEL:** D229 2.9L (1980→), 3.9L (1981→), 5.9L (1981→1988), TBD229 5.9L (1983→1988), SLC (JOHN DEERE): 7200 TURBO 5.9L (1986→), **VALTRA DO BRASIL (VALMET):** 685 3.0L (1992→), 685 ECO 3.0L

(1994→)

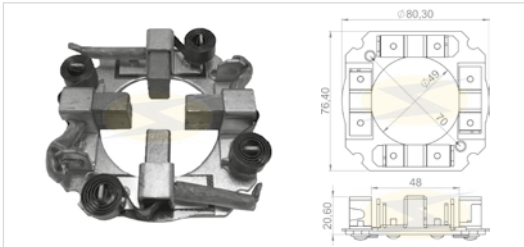

Magneti Marelli

UF - 1.139

Especificações / Features: 12V, Tipo / Type: E95R - Escova / Brush: 8 x 19 x 18,2 mm

UF - 1.139/2 2 escovas / brushes

(L x A x C / W x H x L)

UF - 1.139/4 4 escovas / brushes

Original: 855 403 41

Partida / Starter: 632 218 31, 632 220 30, 632 220 31, 632 220 34, 632 220 35, 632 220 36, 632 220 38, 632 220 39, 632 221 30, 632 221 31

Aplicação / Application: **IVECO:** FURGÃO, **FIAT:** DUCATO

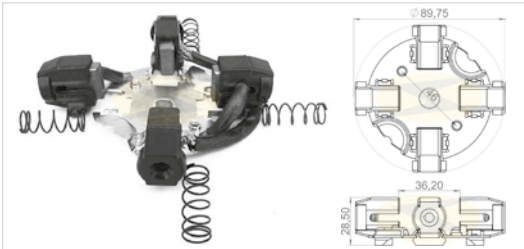

Magneti Marelli

UF - 1.140

Especificações / Features: 12V, Tipo / Type: E80E 0,9-12 - Escova / Brush: 7 x 13 x 17,5 mm

UF - 1.140/3 3 escovas / brushes

(L x A x C / W x H x L)

Original: 832 244 61, 832 253 26

Partida / Starter: 631 020 03, 631 020 04, 631 020 07, 631 020 08, 632 229 00, 632 229 01, 632 230 85, 632 231 01, 632 231 03, 632 231 08, 632 931 01

Aplicação / Application: **FIAT:** FIORINO 1.0 / 1.5 / 1.6 / 2.0, PALIO, SIENA, STRADA 1.0 / 1.3, TIPO, UNO MILLE

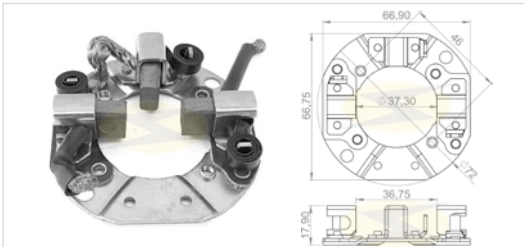

Magneti Marelli

UF - 1.141

Especificações / Features: 12V, Tipo / Type: E80 0,8/1-12 - Escova / Brush: 7 x 13 x 17,5 mm

UF - 1.141/4 4 escovas / brushes

(L x A x C / W x H x L)

Original: 832 212 41

Partida / Starter: 631 110 16, 632 228 31, 632 228 33, 632 228 36, 632 228 38, 632 230 31, 632 230 34, 832 212 41, 832 244 61, 832 253 59, 832 262 16

Aplicação / Application: **FIAT:** PALIO, SIENA 1.6, STRADA 1.6, TIPO, **TOYOTA:** 18R

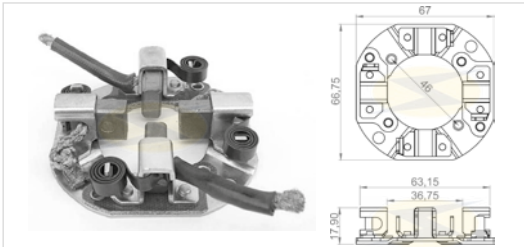

Magneti Marelli

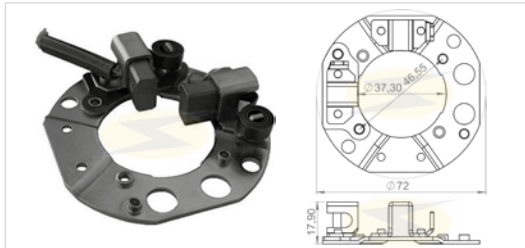

UF - 1.202/2 2 escovas / brushes

Especificações / Features: 12V - Escova / Brush: 7 x 13 x 17,5 mm (L x A x C / W x H x L)

Original: 9945553, 83225326

Partida / Starter: E80, E80E, 63101000, 63101002, 63201008, 63222889, 63222897, 63222905

Aplicação / Application: FIAT: UNO MILLE, SIENA 1.0 8V (FIRE) (2001→), PALIO 1.0 8V (1996→2000), 1.0 / 1.3 8V (FIRE) (2001→)

Magneti Marelli

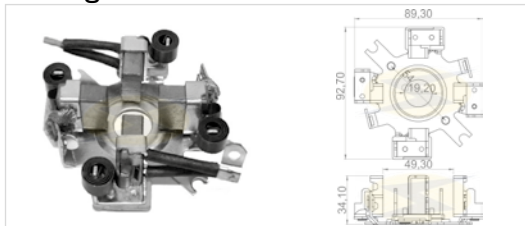

UF - 1.246/4 4 escovas / brushes

Especificações / Features: 12V - Escova / Brush: 10 x 25 x 23 mm (L x A x C / W x H x L)

Original: 72164701, 072164701000

Partida / Starter: 632 16817, 632 16818, 632 16831, 632 16852, 632 16861, 632 16884, 632 16896, MT68AD, MT68LC, MT68MC, MT68PB, MARELLI MT68RA, MT68S, MT68T

Aplicação / Application: IVECO: MK 198301-199112, RENAULT: MASTER I 1989-2001, TRAFIC 2.5D, MESSENGER B120.65 1996-1999, OPEL: ARENA 2.5D, FIAT: TRATOR 160-90 (1984- 1991), F100DT (1986- 1991), F120DT (1986- 1991), F130DT (1986- 1991), 100-90 (1984- 1991), 1380DT (1981- 1984), FORD: NEW HOLLAND TRATOR: 7530, CASE: TRATOR/TRACTOR FARMALL 80 ANO 2009>

Mitsuba

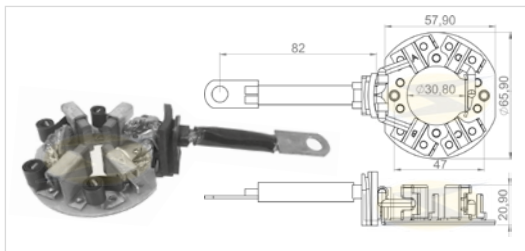

UF - 1.199/4 4 escovas / brushes

Especificações / Features: 12V - Escova / Brush: 5 x 17 x 16 mm (L x A x C / W x H x L)

Original:

Partida / Starter: 31200-P30-902, SM402-13, SM402-13N, SM442, SM442-01, SM442-02, SM442-07, SM442-08, SM442-09, SM442-10, SM442-11, SM442-13, SM442-22, SM442-25, SM442-39, SM442-42

Aplicação / Application: HONDA: CIVIC 1.6 (1993→1997), ACCORD 2.3 (1998→2002) / 3.0i V6 (1998→2002), ODYSSEY 2.3 (1998→1999), HR-V 1.6 16V (1999→), ISUZU: OASIS 2,3L (1998→1999)

Mitsuba

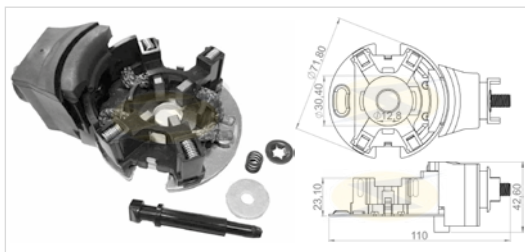

UF - 1.216/4 4 escovas / brushes

Especificações / Features: 12V, Tipo / Type: PMGR 1,6 Kw - Escova / Brush: 4,7 x 12 x 11,5 mm (L x A x C / W x H x L)

Original: 04312-PSA-305, 31210-PSA-J51

Partida / Starter: SM612-05, SM612-09, SM612-063M, SM612-09, SM612-10, SM7102, HONDA: 31200-RAA-A51, 31200-RAA-ARM, 31200-RAA-ARAA43, 31200-RAA-ARAA51, 31200PPA505, 1200PPAA01, 1200PPAA02, 1200PPAA03, 1200PPAA51, LESTER: 17816, 17844, 17870, 17959

Aplicação / Application: ACURA: TSX 2.4L, HONDA: ACCORD 2.4L, CIVIC SI / EX / LX (2007→2013) CR-V 2.4L, ELEMENT 2.4L EX / LX

Mitsubishi

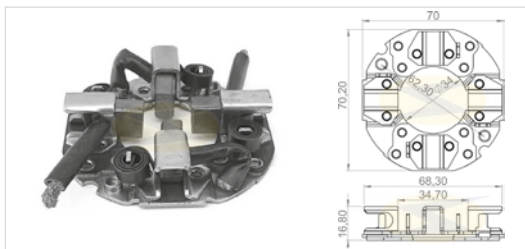

UF - 1.142

UF - 1.142/2 2 escovas / brushes

UF - 1.142/4 4 escovas / brushes

Especificações / Features: 12V, Tipo / Type: OSGR / PLGR - Escova / Brush: 7 x 12 x 16 mm (L x A x C / W x H x L)

Original: M649X20471, ME701467

Partida / Starter: M8T 75071, ME201650, M2T56182, M2T84071, M2T87071, M2T87971, M 008 T75 071, M 002 T87 771, M 002 T87 712A, M 002 T87 712T, M 002 T87 671, MANDO: MG-120413, TM000A36101

Aplicação / Application: AUDI, BOBCAT, CHEVROLET-GM: S10 C/ MOTOR MWM 2.8 SPRINT, CLARK, DODGE, FORD, HYUNDAI: H100 (COM PARTIDA DE MANDO), KIA: TS 2500, MAZDA, MITSUBISHI: L200 SPORT HPE / OUTDOOR, PAJERO SPORT 2.8D, TRATOR, PLYMOUTH, RENAULT: MASTER ATÉ 2005, SUBARU, TOYOTA

Mitsubishi

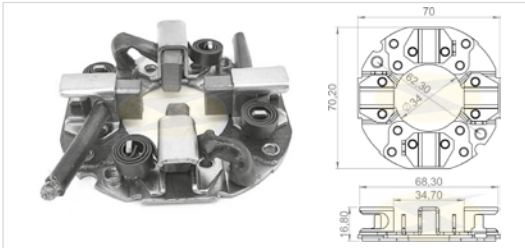

UF - 1.143/2 2 escovas / brushes
UF - 1.143/4 4 escovas / brushes

Especificações / Features: **24V, Tipo** / Type: **OSGR / PLGR** - Escova / Brush: 7 x 12 x 17 mm

(L x A x C / W x H x L)

Original: M649X20771, ME701495

Partida / Starter: M8T 80071, ME 012995, M8T 80171, M8T 85071

Aplicação / Application: **BOBCAT, CLARK, MITSUBISHI:** TRATOR / TRACTOR, **ONAN, TORO, TOYOTA**

Mitsubishi / Valeo / Mando

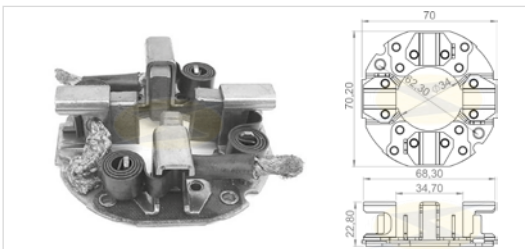

UF - 1.144
UF - 1.144/2 2 escovas / brushes
UF - 1.144/4 4 escovas / brushes

Especificações / Features: **12V, Tipo** / Type: **OSGR / PLGR** - Escova / Brush: 7 x 18 x 18,5 mm

(L x A x C / W x H x L)

Original: M649T05071, ME700127

Partida / Starter: M2T54271, M2T65271, M2T54172, M2T54371, **MANDO:** MG120413, **VALEO:** TM000A23601, **VALEO:** DSL36100-4400

Aplicação / Application: **ACURA, CASE, DODGE, KUBOTA:** MOTORES FRIGORÍFICOS, **MAZDA, MITSUBISHI:** L-200, L-300 - TURBO, **LIBERO, NISSAN:** FRONTIER 3.2 - (1999→), **TORO, YALE, HYUNDAI:** H1, H100, HR

Mitsubishi

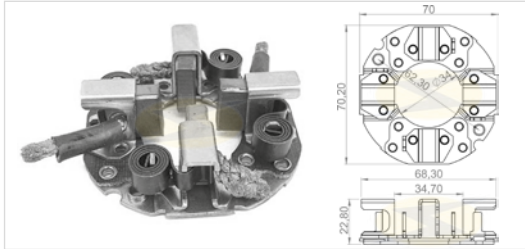

UF - 1.145/2 2 escovas / brushes
UF - 1.145/4 4 escovas / brushes

Especificações / Features: **24V, Tipo** / Type: **OSGR / PLGR** - Escova / Brush: 7 x 18 x 18,5 mm

(L x A x C / W x H x L)

Original: M649T05072, ME700140

Partida / Starter: M002T67871, ME017035, M002T67881, ME017085, M2T65271, M2T65272, M2T66272

Aplicação / Application: **CASE, KUBOTA:** MOTORES FRIGORÍFICOS, **MITSUBISHI:** CAMINHÃO, **YALE**

Mitsubishi

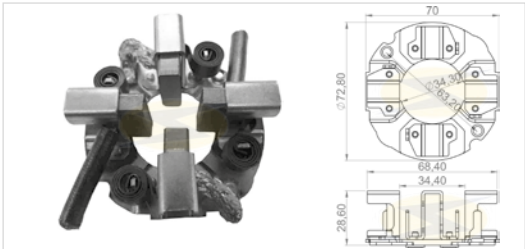

UF - 1.146/2 2 escovas / brushes
UF - 1.146/4 4 escovas / brushes

Especificações / Features: **12V, Tipo** / Type: **PLGR** - Escova / Brush: 8 x 24 x 18 mm

(L x A x C / W x H x L)

Original: F4TZ-11061-A, SBE-351

Partida / Starter: F4TZ-11002B, M008T60871, M008T60872, M008T60873, 32B66-02500, M8T50071, M8T50171, M8T55171, ME087764

Aplicação / Application: **CATERPILLAR:** 320C, **FORD:** VAN, PICK-UP - 7.3 L - DIESEL, **MITSUBISHI**

Mitsubishi

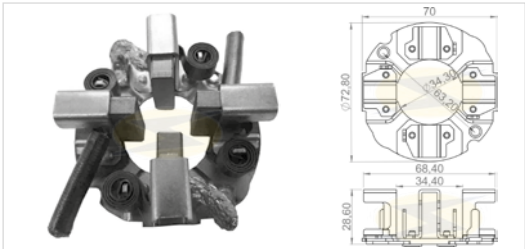

UF - 1.147/2 2 escovas / brushes
UF - 1.147/4 4 escovas / brushes

Especificações / Features: **24V, Tipo** / Type: **PLGR** - Escova / Brush: 8 x 24 x 18 mm

(L x A x C / W x H x L)

Original: M649X20671, ME701448

Partida / Starter: M8T60071, ME077796, M8T60271, M8T60371, M8T60372, M8T60771

Aplicação / Application: **CATERPILLAR:** EMPILHADEIRA / FORKLIFT, **FORD, MITSUBISHI:** FUSO

Mitsubishi

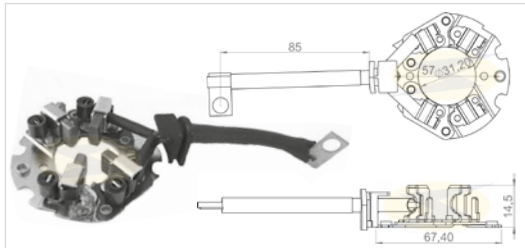

UF - 1.155
UF - 1.155/2 2 escovas / brushes
UF - 1.155/4 4 escovas / brushes

Especificações / Features: 12V, Tipo / Type: PMGR - Escova / Brush: 4,5 x 12 x 17 mm
(L x A x C / W x H x L) CABO CURTO / SHORT CABLE (85mm)
Original: MD611217

Partida / Starter: M1T60081, M1T60281, M1T71381, M1T72581, M1T72583, M1T72583G, M1T72681, M1T73281, M1T73283, M1T77881, M1T78981, M1T79081, TM000A08401

Aplicação / Application: CHRYSLER: NEON, STRATUS, CLARK: EMPILHADEIRA / FORKLIFT, DODGE: (1989→2000), HYUNDAI: ELANTRA, EXCEL, KOMATSU: EMPILHADEIRA / FORKLIFT, MAZDA: (1989→2000), MITSUBISHI: EMPILHADEIRAS / FORKLIFT, ECLIPSE 2.0, 3000GT, PAJERO 3.0, NISSAN: PULSAR, STANZA, EMPILHADEIRAS / FORKLIFT, TOYOTA: EMPILHADEIRA / FORKLIFT, YALE: EMPILHADEIRA / FORKLIFT

Mitsubishi



UF - 1.156/2 2 escovas / brushes
UF - 1.156/4 4 escovas / brushes

Especificações / Features: 12V, Tipo / Type: PMGR - Escova / Brush: 4,5 x 12 x 17 mm
(L x A x C / W x H x L) CABO LONGO / LONG CABLE (110mm)
Original: M649T01271

Partida / Starter: M1T70381, M1T70481, M1T70485, M1T70781, M1T70881, M1T71081, M1T71281, M1T71581, M1T71681, M1T71881, M001T76081, VALEO: 36100-23070, 36100-23071, TM000A37901

Aplicação / Application: CATERPILLAR, CHEVROLET-GM: OMEGA 6CC 3.0, CHRYSLER, CLARK: EMPILHADEIRA / FORKLIFT C/ MITSUBISHI (CGP 25), DODGE: RAIDER 2.6L, RAM 50 PICKUP 2.0L / 2.4L / 2.6L, DODGE COLT: PLYMOUTH COLT 1.6L, DODGE COLT VISTA: PLYMOUTH COLT VISTA 2.0L, EAGLE: SUMMIT 2.4L, TALON 2.0L, FORD, GEO, HYUNDAI: COUPE 2.0 16V (2004), EXCEL, H100, ELANTRA 1.6L / 1.8L / 2.0L (2007), I30 2.0 (2007), TIBURON 1.8L / 2.0L CVVT (2007), SONATA 2.0L, TUCSON 2.0L, INFINITI, JEEP: CHEROKEE / WRANGLER (1997→1998), GRAND CHEROKEE 5.2, V8 5.9, KIA: CEE'D 2.0 (2007), SPECTRA 2.0L (2007), SPORTAGE 2.0 (2007), MAZDA: RX7 1.3L TURBO, RX7 1.3L, PICKUP 2.2L, MERCURY, MITSUBISHI: ECLIPSE 2.0L, 2.0L TURBO, 2.4L, EXPO 2.4L, GALANT 2.4L, NISSAN: D21, PATHFINDER 3.0 V6 (1990→1995), PLYMOUTH, SUBARU, SUZUKI, YALE: EMPILHADEIRA COM / FORKLIFT WITH MITSUBISHI (CGP 25)

Mitsubishi



UF - 1.157
UF - 1.157/2 2 escovas / brushes
UF - 1.157/4 4 escovas / brushes

Especificações / Features: 12V, Tipo / Type: PMGR - Escova / Brush: 4,5 x 18 x 17 mm
(L x A x C / W x H x L) CABO CURTO / SHORT CABLE
Original: F32Z-11061-B, SBE-342, 835 036 71, 832 244 61, 832 253 26

Partida / Starter: M1T74081, M1T74181, M1T74281, M1T74381, M1T74481, M1T74482, M1T74581, M1T74583, M1T74781, M1T74781A, M1T75281, M1T75283, M1T75381, M1T75681, M1T76281, M1T95081

Aplicação / Application: AMC, CHEVROLET-GM, DODGE, EAGLE, FORD, GEO, HYUNDAI, INFINITI, JEEP, MAZDA, MITSUBISHI, SUBARU, SUZUKI, TOYOTA: 2L, 3L

Mitsubishi

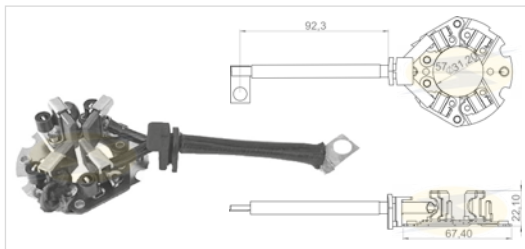

UF - 1.158/2 2 escovas / brushes
UF - 1.158/4 4 escovas / brushes

Especificações / Features: 12V, Tipo / Type: PMGR - Escova / Brush: 4,5 x 18 x 17 mm
(L x A x C / W x H x L) CABO LONGO / LONG CABLE
Original: M649T01671, F32Z-11061-B, SBE342

Partida / Starter: M1T74283, M1T75181, M1T75581, M1T76081

Aplicação / Application: JEEP: CHEROKEE SPORT XJ, (1989→1998), MAZDA: (1989→1998)

Mitsubishi

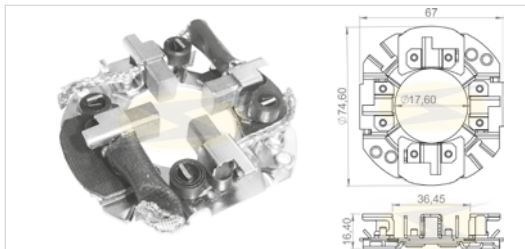

UF - 1.159
UF - 1.159/2 2 escovas / brushes
UF - 1.159/4 4 escovas / brushes

Especificações / Features: 12V, Tipo / Type: OSGR - 4 CAVALETES / 4 Brackets -
Escova / Brush: 7 x 10 x 18 mm (L x A x C / W x H x L)
Original: M649T04471, MD607420

Partida / Starter: M2T50181, M2T50585, M2T51085, M2T52181, M2T52681, M2T52881, M2T52882, M2T53181, M2T53781, M2T53785, M2T58581

Aplicação / Application: BOBCAT, CLARK, DODGE, FORD, GEHL, HYUNDAI: ACCENT, IHC, INGERSOLL-RAND, MAZDA, MELROE, MITSUBISHI, NISSAN, NISSAN: EMPILHADEIRAS / FORKLIFT, ONAN, PERKINS, PLYMOUTH, TORO, YALE: EMPILHADEIRA C/ PARTIDA / FORKLIFT W/ STARTER MITSUBISHI

Mitsubishi

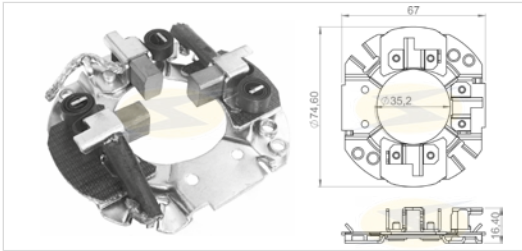

UF - 1.160

3 escovas / brushes

Especificações / Features: 12V, Tipo / Type: DD OSGR - 3 CAVALETES / 3 Brackets -

Escova / Brush: 7 x 10 x 18 mm (L x A x C / W x H x L)

Original: M649T04471

Partida / Starter: M2T20181D, M2T30481, M2T30581, M2T30981, M2T31081, M2T32281, M2T32581, M2T37081, M2T42381, M2T42985, M2T43681, M2T43781, M2T43881, M2T44781, M2T49881, M003T41781

Aplicação / Application: DODGE, EAGLE, FORD, HYSTER, HYUNDAI: EXCEL, JOHN DEERE, KIA, KUBOTA, LINCOLN ELECTRIC, MAZDA, MERCURY, MITSUBISHI, MITSUBISHI: EMPILHADEIRAS / FORKLIFT, NISSAN: EMPILHADEIRAS / FORKLIFT, ONAN, PLYMOUTH, SUZUKI: VITARA (1997→1998), WOODS, HYSTER: EMPILHADEIRAS C/ PARTIDA / FORKLIFT W/ STARTER 918139600, YALE: EMPILHADEIRAS C/ PARTIDA / FORKLIFT W/ STARTER 010476 DN

Mitsubishi

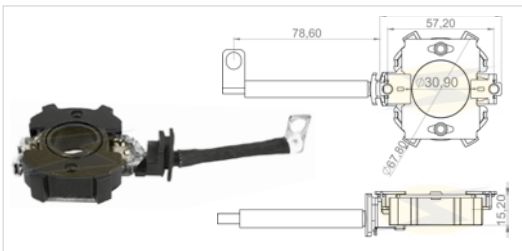

UF - 1.178/4

4 escovas / brushes

Especificações / Features: 12V, Tipo / Type: PMGR - Escova / Brush: 4,5 x 12 x 12,8 mm

(L x A x C / W x H x L) - Cabo longo / Long cable.

Original: M321X04471, M321X04771, M321X05171, M321X07071

Partida / Starter: 9181 396-00, (FF184 00, 000T92581), M000T84882ZC, MOT60081, MOT60082, MOT60186, MOT60187, MOT70881, MOT80081, MOT80281, MOT80281A, MOT80285, MOT80285A, MOT80381, MOT80581, MOT80783, MOT80981, MOT81081, MOT81281, MOT81284, MOT81681, MOT82081, MOT82281, MOT83981, MOT84881ZC, MOT85081, MOT85681, MOT85881, MOT85981, M001T86281, MOT86481, MOT91181ZC, M1T60285, M1T78681, M1T79482, M1T79781, M1T83981, M1T84171ZC, M1T84181, M1T84381, M1T84981, M1T85881, M1T86081, M1T86182, M001T86281ZC

Aplicação / Application: CHEVROLET-GM, CHRYSLER: CONCORDE, PT CRUISER, CITROEN: C5 (2001→2004), PICASSO, DODGE: IN-

TREPID 2.7L, HYSTER: EMPILHAD. / FORKLIFT (1995→2005), JEEP: WRANGLER L6 4.0 TJ / YJ (1988-1998), CHEROKEE SPORT L6 4.0 XJ, KIA: SPORTAGE, MAZDA: MPV 3.0L, PROTEGE 1.6L / 1.8L / 2.0L, MITSUBISHI: PAJERO / MONTERO: 3.0L (2000→2003) / 3.5L (1999→2004) / 3.8L (2001→2002), MIRAGE 1.5L / 1.8L, NISSAN: 200SX 1.6L (1995→1998), EMPILHAD. / FORKLIFT, SENTRA 1.6L (1995→1999), FRONTIER 2.4L (1999→2001), PICKUP 2.4L, LIFT TRUCK NISSAN, XTERRA 2.4L (2000→2001), PEUGEOT: 206, 406 (1999→2004), PLYMOUTH, SUBARU: FOREST 2.5L, IMPREZA (1997→2003), 2.2L / 2.5L, OUTBACK 2.2L / 2.5L, SUZUKI: VITARA

Mitsubishi

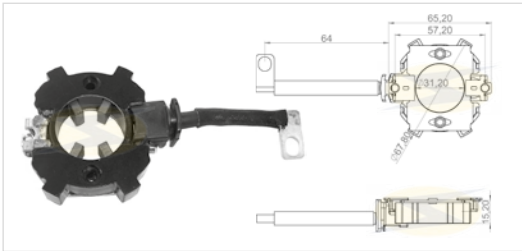

UF - 1.179/4

4 escovas / brushes

Especificações / Features: 12V, Tipo / Type: PMGR - Escova / Brush: 4,5 x 12 x 12,8 mm

(L x A x C / W x H x L), Cabo curto / Short cable.

Original:

Partida / Starter: M000T843814, MD61 9097, MD61 9311

Aplicação / Application: HYSTER: EMPILHADEIRA / FORKLIFT (1995→2005), CHRYSLER, DODGE, MAZDA, MITSUBISHI, NISSAN, SUBARU

Mitsubishi

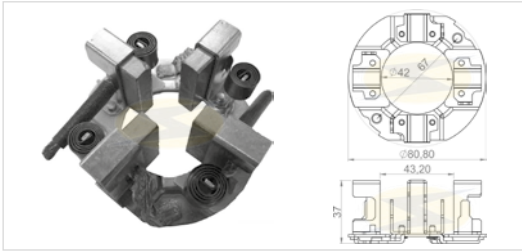

UF - 1.187/4

4 escovas / brushes

Especificações / Features: 24V - Escova / Brush: 8 x 30 x 18,2 mm (L x A x C / W x H x L)

Original:

Partida / Starter: M009T61671, M009T62572ZA, M009T644471ZA, 2T0911023G, MM0097662572ZA, 2509110223A

Aplicação / Application: IVECO: STRALLIS, VOLKSWAGEN: CONSTELLATION 25 370, VOLVO: NH / FH

Mitsubishi

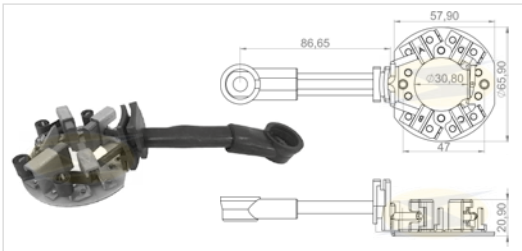

UF - 1.200/4

4 escovas / brushes

Especificações / Features: 12V - Escova / Brush: 5 x 17 x 16 mm (L x A x C / W x H x L)

Original:

Partida / Starter: SM 402-03, SM 402 202

Aplicação / Application: ISUZU, ACURA, HONDA: CIVIC, ACCORD 2.2L, PRELUDE 2.2L / 2.3L, ODYSSEY 2.2L / 2.3L

Mitsubishi

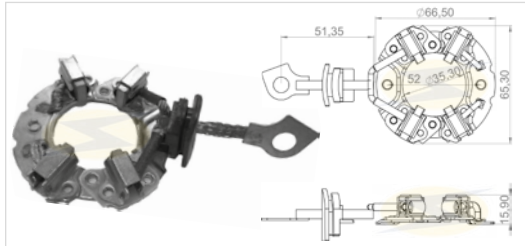

UF - 1.231/4 4 escovas / brushes

Especificações / Features: 12V, 0,8 Kw - Escova / Brush: 5 x 10,6 x 12,5 mm

(L x A x C / W x H x L)

Original:

Partida / Starter: M2T40081, M3T32581, M3T32582, M3T32583, M3T32591, M3T32592, M3T32593, M3T41081, M3T41083, M3T42781, MITSUBISHI MOTORS MD001333, MD034120, MD066761, MD081567, MD081568, MD100431, MD162836, MD162837, MD162838, MD180239, MANDO LESTER 16-940, MANDO MC109032, M39376

Aplicação / Application: **HYUNDAI:** ELANTRA, EXCEL, I30, SITEMA, **DODGE:** (1981→1994), PLYMOUTH 1.4L / 1.5L / 1.6L / 1.8L / 2.0L / 2.4L, **EAGLE:** (1989→1996), ENGINES 1.5L / 1.8L / 2.4L, **MITSUBISHI:** (1983→1996), ENGINES 1.5L / 1.6L / 1.8L / 2.0L / 2.4L

Mitsubishi

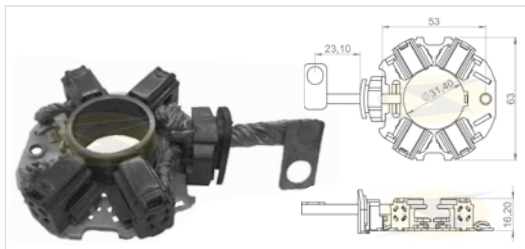

UF - 1.234/4 4 escovas / brushes

Especificações / Features: 12V, Tipo / Type: MR9943 (PMGR) - 1,2 Kw - Escova / Brush:

4,5 x 12 x 12 mm (L x A x C / W x H x L) - GIRO SENTIDO HORÁRIO / Clockwise Rotation

Original: MOT87681

Partida / Starter: M00T30771, M00T32071ZC, M000T32071, MOT32071, MOT32071ZC. (CHRYSLER 05034555AA, 5034555AA), M000T20672

Aplicação / Application: **CHRYSLER:** SEBRING 2.4L(144) L4 (2007→2009), **DODGE:** AVENGER 2.4L(144) L4 (2008→2009), CALIBER 1.8L (110) L4 (2007→2009), CALIBER 2.0L(122) L4 (2007→2009), CALIBER 2.4L(144) L4 (2007→2009), JOURNEY 2.4L(144) L4 (2009), **FIAT:** FREEMOUNT 2.4 (144) L4, **JEEP:** COMPASS 2.0L(122) L4 (2007→2009), COMPASS 2.4L(144) L4 (2007→2009), PATRIOT 2.0L(122) L4 (2007→2009), PATRIOT 2.4L(144) L4 (2007→2009), **MITSUBISHI:** AIRTREK 2.4 GRANDIS, PAJERO TR4, PAJERO IO 2.0L (1999→), LANCER 1.6 / 2.0 (2003→2007), COLT 1.6 / 2.0 (2003→2007), **MAZDA**

Mitsubishi

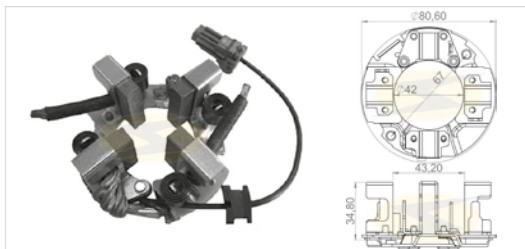

UF - 1.244/4 4 escovas / brushes

Especificações / Features: 24V - 5,5 Kw - Escova / Brush: 8 x 30 x 18,2 mm (L x A x C / W x H x L)

Original:

Partida / Starter: M0009T61171, M009T82179, 11127679, 1556967, 20430564, 8500087

Aplicação / Application: **VOLVO:** B12, FM12, FH 12, NH

Mitsubishi

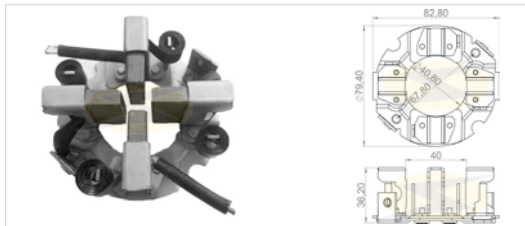

UF - 1.248/4 4 escovas / brushes

Especificações / Features: 24V - Escova / Brush: 8 x 30 x 23 mm (L x A x C / W x H x L)

Original:

Partida / Starter: M009T83671, M009T80471, M009T80472, M009T80473, M009T80671, M009T80672, M009T80771, M9T83671, M9T80472, A0061511501, A0061516901, 0061516901

Aplicação / Application: **MERCEDES BENZ:** CAMINHÕES ACTROS E AXOR, ONIBUS O580, **VOLVO:** ESCAVADEIRA 700/460/360

Nippondenso

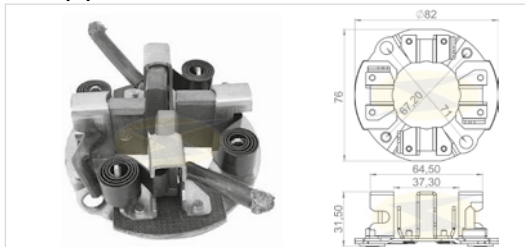

UF - 1.153

Especificações / Features: 12V, Tipo / Type: OSGR - Escova / Brush: 8 x 25 x 21 mm

UF - 1.153/2 2 escovas / brushes

(L x A x C / W x H x L)

UF - 1.153/4 4 escovas / brushes

Original: 28140-77090, 3964427

Partida / Starter: 028000-5520, 028000-5880, 028000-6880, 028000-6561, 028000-5560, 028000-7221, 028000-7231, 028000-9160, 028000-9040, 128000-0216, 128000-5090, 128000-1560, 128000-4111, 28100-58030, 28100-54260, 428000-1850, 22800-03460

Aplicação / Application: **ALLIS-CHALMERS, ASIA MOTORS:** TOPIC, CASE, CATERPILLAR, CUMMINS, DAIHATSU, DODGE, HINO, ISUZU, TRUCK, JOHN DEERE, KOMATSU, KUBOTA, MITSUI-DEUTZ, TELEDYNE / CONTINENTAL, TOYOTA: EMPILHADEIRA / FORKLIFT, VERSATILE, WHITE, YANMAR, TOYOTA: BANDEIRANTES COM MOTOR 14B, **HYUNDAI:** H100

Nippondenso

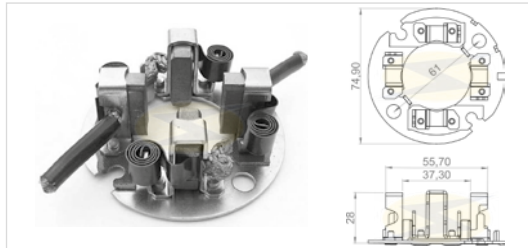

UF - 1.154

2 escovas / brushes

UF - 1.154/2

4 escovas / brushes

Especificações / Features: 12V, Tipo / Type: OSGR - Escova / Brush: 8 x 25 x 15 mm

(L x A x C / W x H x L)

Original: 028510-0640, 28140-50020, 28140-54070

Partida / Starter: 028000-9030, 028000-8130, 028000-7001, 028000-7791, 028000-2880, 028000-7370, 028000-7372, 028000-7373, 128000-0040, 128000-1180, 128000-0960, 228000-0240, 228000-0400, 228000-5023, 28100-67050

Aplicação / Application: ALLIS-CHALMERS, CATERPILLAR, CHEVROLET-GM, DODGE, GMC, ISUZU, KIA MOTORS: BESTA 2.7, KOMA-TSU, KUBOTA, LEXUS, MITSUI-DEUTZ, THERMO KING

Nippondenso

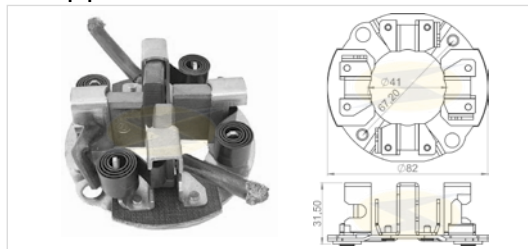

UF - 1.161/2

2 escovas / brushes

UF - 1.161/4

4 escovas / brushes

Especificações / Features: 24V, Tipo / Type: OSGR - Escova / Brush: 8 x 25 x 21 mm

(L x A x C / W x H x L)

Original: 028510-0500, 28140-77090

Partida / Starter: 028000-5530, 028000-5690, 028000-5300, 028000-5570, 028000-6460, 028000-6200, 028000-7810, 028000-5860, 028000-5861, 028000-5550, 028000-6010, 028000-6012, 028000-9040, 028000-9760, 028000-9140, 128000-1560, 128000-1561, 128000-1570, 128000-1571, 128000-8620, 128000-8621

Aplicação / Application: ALLIS - CHALMERS, ASIA MOTORS: TOPIC, CASE, CATERPILLAR, CUMMINS, DAIHATSU, DODGE, HINO, ISUZU: TRUCK, JOHN DEERE, KOMATSU, KUBOTA, MITSUI-DEUTZ, TELEDYNE/CONTINENTAL, TOYOTA: EMPILHADEIRA / FORKLIFT, COASTER, VERSATILE, WHITE, YANMAR

Nippondenso

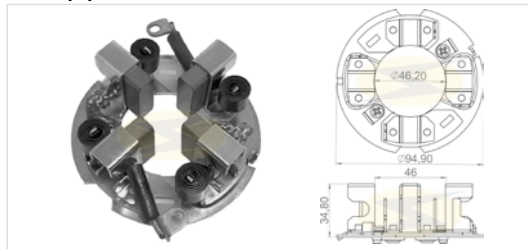

UF - 1.169/4

4 escovas / brushes

Especificações / Features: 12V, Tipo / Type: OSGR - Escova / Brush: 10 x 30 x 20 mm

(L x A x C / W x H x L)

Original: 028510-0880, 1.81118-0430, 28140-1310A

Partida / Starter: 128000-0492, 128000-2450, 128000-2470, 128000-2740, 128000-4220, 128000-4910, 128000-5370, 128000-5510, 128000-5620, 128000-5730, 81100-234-0, 228000-331, 228000-332, 228000-573, 228000-585, 228000-6870

Aplicação / Application: CATERPILLAR, CUMMINS, CASE, ISUZU

Nippondenso

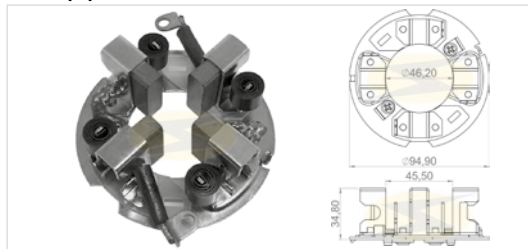

UF - 1.170/4

4 escovas / brushes

Especificações / Features: 24V, Tipo / Type: OSGR - 5.5 Kw - Escova / Brush: 10 x 30 x 20 mm

(L x A x C / W x H x L)

Original: 028510-0880, 181118-043-0, 28140-1310A

Partida / Starter: 128000-2740, 128000-4250, 128000-4685, 128000-2560

Aplicação / Application: CATERPILLAR, CUMMINS, CASE, DODGE, ISUZU

Nippondenso / Denso / Delco / Magneti Marelli

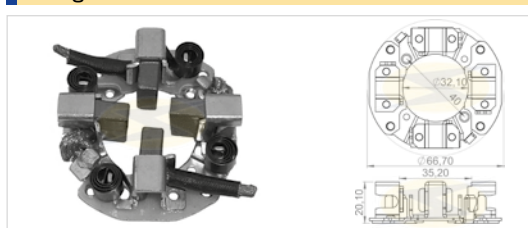

UF - 1.208/4

4 escovas / brushes

Especificações / Features: 12V, Tipo / Type: OSGR / M70R - Escova / Brush: 7 x 16 x 16 mm

(L x A x C / W x H x L)

Original: 028510-0750, 028510-5320

Partida / Starter: 12 8000-701, 12 8000-712, 12 8000-756, 12 8000-771, 12 8000-822, 12 8000-845, 12 8000-878, 12 8000-938, 12 8000-975, 22 800-036, 22 800-047, 22 800-071, 22 800-090, 22 800-162, 22 800-255, 22 800-301, 22 800-303, 22 800-328, 22 800-399, 22 800-642, 22 800-720, 22 800-8110, 22 800-8111, DELCO: 10455703, DELCO: 10455709, DENSO FIRST TIME: 280-0299, MAGNETI MARELLI: 63111016

Aplicação / Application: ACURA, CHRYSLER, DODGE, EAGLE, FIAT: TEMPRA / TEMPRA SW, BRAVA, PALIO, GEO, GM: CORVETTE V8 5.7L (350) (1988-1996), HONDA, ISUZU, HARLEY-DAVIDSON, PLYMOUTH, TOYOTA: EMPILHADEIRA / FORKLIFT 1C / 2C

Nippondenso

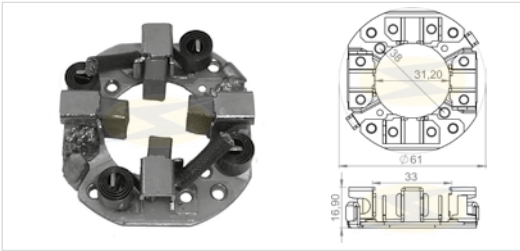

UF - 1.209/4 4 escovas / brushes

Especificações / Features: 12V, Tipo / Type: OSGR - Escova / Brush: 6,5 x 12,9 x 14,2 mm

(L x A x C / W x H x L)

Original: 028510-5190

Partida / Starter: 128000-5210, 128000-5211, 128000-5680, 128000-5682, 128000-6420, 128000-6422, 128000-6720, 128000-6721, 128000-7400, 22800-7091, 22800-9631, 22800-9642, 22800-9651, 428000-0321, 428000-0960, 428000-3420, 428000-5011, 428000-5800

Aplicação / Application: DENSO, GEO, HONDA: CIVIC 1.7L (2001→2004), 1.8L (2006→2008), FIT 1.5L (2007→2008), ISUZU, KUBOTA: EMPILHADEIRA / FORKLIFT, TOYOTA: 4E, 5E, SUZUKI, YANMAR

Nippondenso

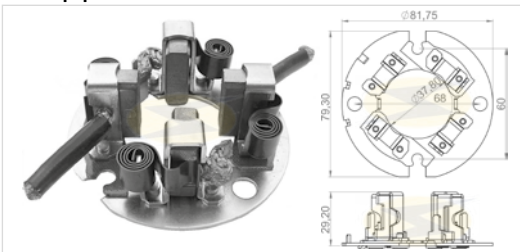

UF - 1.211/4 4 escovas / brushes

Especificações / Features: 12V, Tipo / Type: OSGR - Escova / Brush: 8 x 25 x 15 mm

(L x A x C / W x H x L)

Original: 028510-5010

Partida / Starter: 128000-0832, 128000-5350, 128000-5760, 128000-9560, 22800-0200, 22800-0391, 28140-60040-000

Aplicação / Application: KIA / ASIA MOTORS: BESTA 2.7 / 2.8 / 3.0, CAMINHÃO BONGO, DAIHATSU, TOYOTA: HILUX 3.0 (2000→2004) / 2.8D

Nippondenso

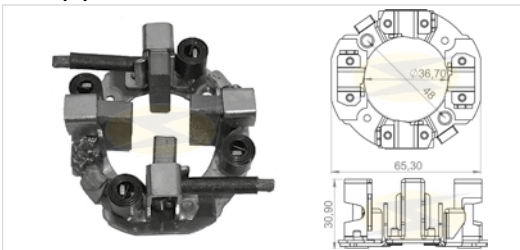

UF - 1.212/4 4 escovas / brushes

Especificações / Features: 12V, Tipo / Type: OSGR - Escova / Brush: 7 x 25 x 15,5 mm

(L x A x C / W x H x L)

Original: 028510-5800

Partida / Starter: 28100-54380, 228000-2120, 228000-2680, 228000-2690, 228000-2700, 228000-2980, 228000-3260, 228000-3840, 228000-3850, 228000-3851, 228000-4570, 228000-4571, 228000-4580, 228000-4590, 228000-4740, 228000-4750, 228000-5120, 228000-5861, 228000-8430, 228000-8440

Aplicação / Application: ACURA, DODGE, GEHL, LEXUS, HYSTER, PETER, NEW HOLLAND, TOYOTA: SL, DYNA 100 (1995→) / 150 2.4 (1987→1988), HIACE 2.4 (1984→1989) HIACE 5L BUFALO 12V, HILUX 2.4 (1989→), LAND CRUISER 2.4D (1984→), YALE

Nippondenso

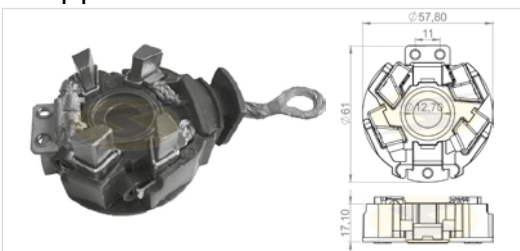

UF - 1.242/4 4 escovas / brushes

Especificações / Features: 12V, Tipo / Type: DND-09 SERIES - 1,6 Kw - Escova / Brush: T 4,2 /

4,5 x 8,4 x 15 mm (L x A x C / W x H x L) - CCW - Counter Clock Wise / Sentido Anti-Horário

Original: 128099-6320, 128099-6321, TOYOTA: 28100-28041, 22800-990

Partida / Starter: 2810028040, 2810028041, 281002804184, 281000A010, 2810020020, 228000-9902, LRS02261, 17825, 4280000340, 4280000341, 4280001311

Aplicação / Application: TOYOTA: HILUX 2.7 VVTi FLEX, HILUX 2.5 DIESEL, SW4 2.7 VVTi FLEX, FORTUNER 2.7 VVTi FLEX, CAMRY 4 CIL. 2.4L 144CID (2002→2006), CAMRY 6 CIL. 3.0L (2002→2005), CAMRY V6 3000 (2003→2008), HIGHLANDER: 4 CIL. 2.4L (2004→2007), SOLARA 4 CIL. 2.4L 144CID (2002→2006), SOLARA 6 CIL. 3.0L (2002→2005), COROLLA (2003→2008), MATRIX (2003→2008), VIGO 2.7 VVTi FLEX, VIGO 2.5 DIESEL, LEXUS: ES300 6 CIL. 3.0L (2002→2003), SCION TC 4 CIL. 2.4L (2005→2006), PONTIAC: VIBE 1.8L (2003→2008) SCION

Prestolite

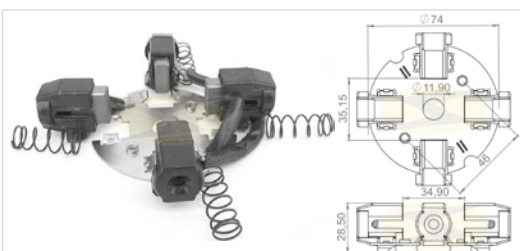

UF - 1.130

Especificações / Features: 12V, Tipo / Type: M93R - Escova / Brush: 8 x 19 x 18,2 mm

UF - 1.130/2 2 escovas / brushes

(L x A x C / W x H x L) (DELPHI / LUCAS) KO 12066

UF - 1.130/4 4 escovas / brushes

Original: 352.58.637 KO 12038, 352.58.637 KO 12039

Partida / Starter: 352.58.270, 352.58.380, 352.58.580, 352.58.940, 352.58.950, 352.58.490, 352.58.540, 352.58.660, 352.58.690, 352.58.710, 352.58.820, 352.58.880, 352.58.960, 352.59.040, 352.59.270, 352.59.400, 352.59.430, 352.59.600, 352.59.750, 352.59.760, 352.59.870, 352.61.305, 352.61.860, 352.62.710

Aplicação / Application: AGRALE: ÔNIBUS VOLARE, CHEVROLET-GM: BLAZER DLX, PICK-UP S10 C/ MOTOR MAXION HS, PICK-UP D20, SILVERADO C/ MOTOR / W/ENGINE MWM, CUMMINS: MOTORES SÉRIES 6BT (DIANTEIRO) / B6 / BT5.9L, FORD: CARGO 1416 / 1722 / 1716, F-1000, F-14000 C/ MWM, PICK-UP F-100, F-1000, RANGER 2.5 / 2.8 / 3.0, JOHN DEERE: TRATORES, LAND ROVER: DEFENDER / DISCOVERY 4CC 2.5 15-160,

MASSEY-FERGUSON: TRATOR C/ MOTOR / W/ENGINE 4 CIL, MAXION: MOTORES / ENGINES, MERCEDES-BENZ: 180D - KOMBI ESPANHOLA, ÔNIBUS, CAMINHÕES, SPRINTER C/ MOTOR / W/ENGINE MAXION HS, PERKINS: MOTORES 4.203 / 3.152 / 4.236 / 6.354, PEUGEOT: 504, 505, VÁRIOS C/ MOTOR / W/ENGINE INDENOR, PORSCHE, RENAULT: CLIO, VOLKSWAGEN: CAMINHÃO

Prestolite

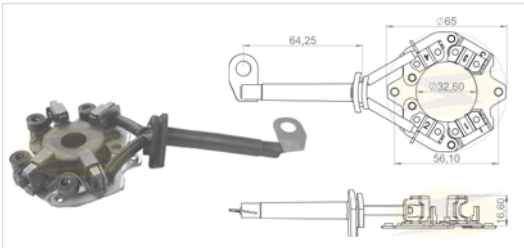

UF - 1.135

2 escovas / brushes

4 escovas / brushes

Especificações / Features: 12V, Tipo / Type: M74R - Escova / Brush: 4,5 x 14 x 17 mm

(L x A x C / W x H x L) (DELPHI / LUCAS)

Original: 352.58.566

Partida / Starter: 352.58.400, 352.58.430, 352.58.510, 352.58.560, 352.58.600, 352.58.730, 352.58.750, 352.58.790, 352.58.850, 352.58.860, 352.58.890, 352.612.60

Aplicação / Application: **CHEVROLET-GM:** PICK-UP C20, SILVERADO - C/ MOTOR 6 CIL. GASOLINA, CORSA 1.4 / 1.6, CORSA COMBO 1.4 / 1.6, **FIAT:** 128 SUPER EUROPA, 147 BRIO / SPR / SPT, DUNA 1300 / 1500 / 1.4 / 1.6, FIORINO 1.4 / 1.6, PICK-UP 1.4 / 1.6, REGATTA 1.4 / 1.6, **RENAULT:** CLIO 1.8 / 1.6, R 19 1.8 / 1.4 / 1.6 / 1.7 C/ CARBURADOR, 19 1.8 / 1.6, **PEUGEOT:** 205 / 306 / 405 / BOXER, **FORD:** ESCORT ZETEC (1997) 1.8 / 2.0, FOCUS-ZETEC 1.8, MONDEO 1.8 / 2.0 / ZETEC, FIESTA 1300 / 1.4 (COM E SEM AR), RANGER DURATEC 2.3 GAS. / 3.0L NGD INT., **NISSAN:** FRONTIER, XTERRA, **TROLLER:** T4 3.0L NGD INT., **VOLKSWAGEN:** GOL 1.6 / 1.8 / 2.0 (COM AR) / 1.000 (BRASIL), SAVEIRO CHT 1.6

ESCORT ZETEC (1997) 1.8 / 2.0, FOCUS-ZETEC 1.8, MONDEO 1.8 / 2.0 / ZETEC, FIESTA 1300 / 1.4 (COM E SEM AR), RANGER DURATEC 2.3 GAS. / 3.0L NGD INT., NISSAN: FRONTIER, XTERRA, TROLLER: T4 3.0L NGD INT., VOLKSWAGEN: GOL 1.6 / 1.8 / 2.0 (COM AR) / 1.000 (BRASIL), SAVEIRO CHT 1.6

Prestolite

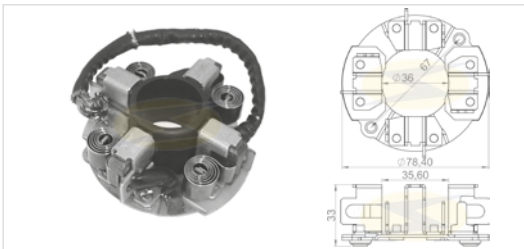

UF - 1.195

2 escovas / brushes

4 escovas / brushes

Especificações / Features: 24V, Tipo / Type: M100R - Escova / Brush: 8 x 25 x 21 mm

(L x A x C / W x H x L) (DELPHI / LUCAS / INDIEL)

Original: K-01266

Partida / Starter: 352.59.240, 352.59.440, 352.59.460, 352.59.770, 352.59.780, 352.61.000, 352.61.130

Aplicação / Application: **MERCEDES-BENZ:** 0371, OF215, OF1315, 1316, 1318, 1320, ONIBUS / BUS 1214 / 1414 / 1418 / 1614, **CUMMINS:** 5.9 SERIE B ELETRONIC, **MWM:** 4CC, 6CC, **VOLKSWAGEN:** 17.250E, 26.250, ONIBUS / BUS, **IVECO:** MWM X10 226 SERIES, **VOLVO:** VM17 MWM X10 229 SERIE, VM23 MWM X10 229 SERIE

Prestolite

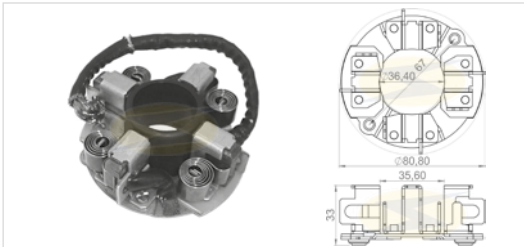

2 escovas / brushes

4 escovas / brushes

Especificações / Features: 12V, Tipo / Type: M100R - Escova / Brush: 8 x 25 x 21 mm

(L x A x C / W x H x L) (DELPHI / LUCAS / INDIEL)

Original: K-01236, 35262079

Partida / Starter: 352.59.200, 352.59.260, 352.59.290, 352.59.450, 352.59.500, 352.59.510, 352.59.520, 352.59.530, 352.59.550, 352.59.730, 352.59.810, 352.59.820, 352.59.830, 352.59.840, 352.60.830, 352.60.840, 352.60.900, 352.60.910, 352.61.050, 352.61.135, 352.61.160

Aplicação / Application: **CATERPILLAR, CHRYSLER, CUMMINS, FORD, FREIGHTLINER, GRADALL, INTERNATIONAL NAVISTAR, JOHN DEERE, VOLKSWAGEN, DODGE:** RAM 2.500 CUMMINS 6CC 5.9L,

Valeo

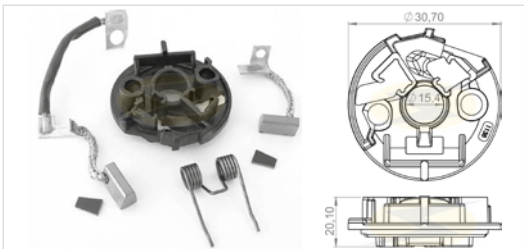

2 escovas / brushes

Especificações / Features: 12V, Tipo / Type: D6RA, PMGR - Escova / Brush: 4,5 / 9T x 11 x 18 mm (L x A x C / W x H x L)

Original: 133647, 594070

Partida / Starter: 432598, D6RA5, 432622, D6RA133, D6RA5, D6RA6, D6RA12, D6RA16, D6RA18, D6RA20, D6RA61, D6RA65, D6RA85, D6RA165, D6RA185

Aplicação / Application: **RENAULT:** CLIO 1.8I, LAGUNA 1.8I / 2.0I, MÉGANE 1.6I / 2.0I, R19 1.4I / 1.6 / 1.8, **CHEVROLET-GM:** CORSA EFI 1.0 / MPFI 1.0, **PEUGEOT:** 309 - 1.1 / 1.4, 405 - 1.4, **CITROEN:** AX -1.0 / 1.1 / 1.3 / 1.4, BX-1.0, XSARA 1.6, XM V6TT

Valeo

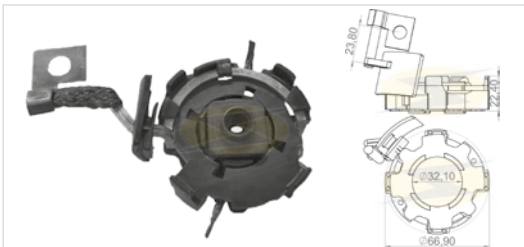

4 escovas / brushes

Especificações / Features: 12V, Tipo / Type: D7G11 - Escova / Brush: 7 x 13 x 10,8 mm

(L x A x C / W x H x L)

Original:

Partida / Starter: 8200225336, 8200225338, D7G11

Aplicação / Application: **RENAULT:** MASTER ELETRÔNICO DCI120 (2005-), ESPACE MHIII, LAGUNA, VEL SATIS, TRAFIC, **OPEL:** MO-VANO, VIVARO, **VAUXHALL:** MOVANO, VIVARO, **NISSAN:** INTERSTAR, PRIMASTER

Valeo



UF - 1.171/4 4 escovas / brushes

Especificações / Features: 12V, Tipo / Type: D7E, DD - Escova / Brush: 6,5 x 8 x 11 mm

(L x A x C / W x H x L)

Original: 187517, 594351, 594479, 594290

Partida / Starter: D7E4, D7E6, D7E8, D7E10, D7E11, D7E15, D7E18, D7E19, D7E20, D7E22, D7E23, D7E27, D7E28, D7E39, D7E48, D7E52, D7E D28, BD7E17, BD7E44, 93264950

Aplicação / Application: FIAT: PALIO, STILO, CHEVROLET-GM: ASTRA, CELTA, CORSA, MERIVA, PEUGEOT: 206, RENAULT: CLIO, KANGOO, MEGANE, R19, R11, R12, R19, SCENIC, KIA: SPORTAGE

Valeo

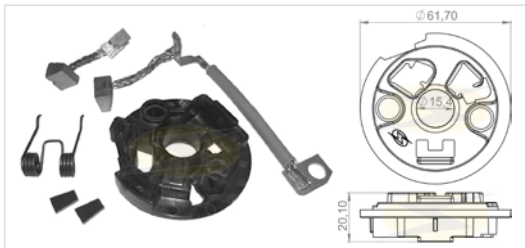

UF - 1.172/2 2 escovas / brushes

Especificações / Features: 12V, Tipo / Type: PMGR - Escova / Brush: 4,7 / 9T x 11 x 14 mm

(L x A x C / W x H x L)

Original: 181961, 594072

Partida / Starter: D6RA8, D6RA10, D6RA572

Aplicação / Application: PEUGEOT, DAEWOO, DEUTZ, JEEP: (1999→2003), (1987→1993), GRAND CHEROKEE 5.2L / 4.7L, LOMBARDINI, MERCEDES, SATURN, TORO, VOLVO PENTA, VAUXHALL: CORSA 1.0 / 1.2 (1997→2000), VECTRA 2.0 D, ASTRA 2.0 D, OPEL, VOLKSWAGEN: IBIZA, VOLVO: 240, 740, 760

Valeo



UF - 1.173/3 3 escovas / brushes

Especificações / Features: 12V, Tipo / Type: DD - Escova / Brush: 6,5 x 8 x 11 mm

(L x A x C / W x H x L)

Original: 494818

Partida / Starter: USC 867838-864608 G, D7E34

Aplicação / Application: FORD: FIESTA, COURIER, KA, ESCORT, ECOSPORT, RENAULT: CLIO

Valeo

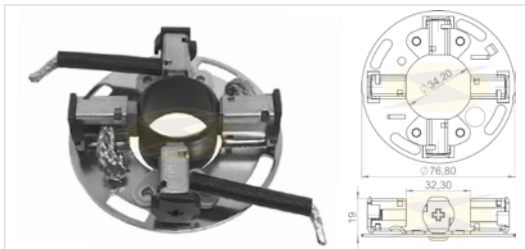

UF - 1.186/4 4 escovas / brushes

Especificações / Features: 12V, Tipo / Type: D7R Series - Escova / Brush: 7 x 14 x 14 mm

(L x A x C / W x H x L)

Original:

Partida / Starter: 0041518901, 004151890180, 0041519201, 004151920180, 0041519701, 004151970180, 0051511301, 005151130180, 005151130187, D7524, D7R1, D7R2, D7R3, D7R4, D7R5, D7R8, D7R11, D7R12, D7R14, D7R15, D7R16, D7R17, D7R18, D7R19, D7R20, D7R22, D7R25, D7R26, D7R27, D7R28, D7R33, D7R34, D7R35, D7R36, D7R40, D7R41, D7R42, D7R43, D7R44, D7R46, D7R47, D7R48, D7R49, D7R51, D7R53, D7R57, D7R64, D7R65, D7R70, D7RS1, D7RS7, D7RS29, D7RS30, D7RS31, D7RS50, D7RS129, D7RS130, D7RS131, D7RS150, D7RSA2, D7RSA4, D7RSA5, D7RSA7, D7RSA8, D7RSA10, D7RSA11, TM000A36101, DSL36100-42350, TS22ER12, TS22ER13, 2H0911023A

Aplicação / Application: FIAT: DUCATO, HYUNDAI: HR, H100, KIA: BONGO, MB: SPRINTER CDI 311 / 313, MITSUBISHI: L200, KATANA,

RENAULT: MASTER (2010→), VOLKSWAGEN: AMAROK 2.0 TDI

Valeo

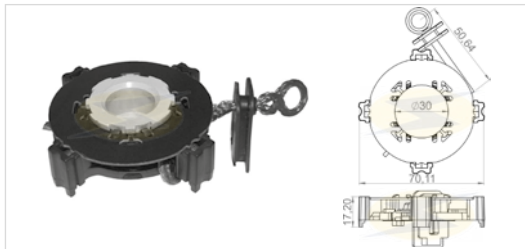

UF - 1.203/4 4 escovas / brushes

Especificações / Features: 12V, Tipo / Type: D7E, DD - Escova / Brush: 6,5 x 8 x 11 mm

(L x A x C / W x H x L)

Original: 594381

Partida / Starter: D7E56

Aplicação / Application: RENAULT: SANDERO STEPWAY (2009), VOLKSWAGEN: PÔLO, GOLF 1.6, FOX, CROSSFOX

Valeo

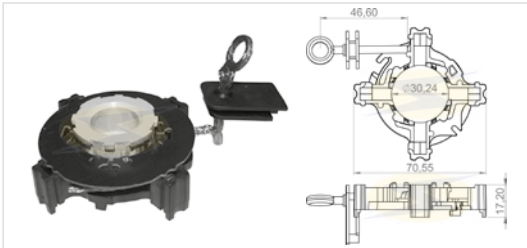

UF - 1204/3 3 escovas / brushes

Especificações / Features: 12V, Tipo / Type: D7E, DD - Escova / Brush: 6,5 x 8 x 11 mm

(L x A x C / W x H x L)

Original: 594290

Partida / Starter: D7E1, D7E16, D7E24, D7E29, D7E30, D7E31, D7E32, D7E33, D7E34, D7E35, D7E36, D7E37, D7E39, D7E43

Aplicação / Application: FIAT: 147, DUNA, ELBA, FIORINO, OGGI, PALIO, PANORAMA, PICKUP, PREMIO, SIENA, SPAZIO E UNO, FORD: FIESTA, COURIER, KA, ESCORT E ECOSPORT, PEUGEOT: 206

Valeo

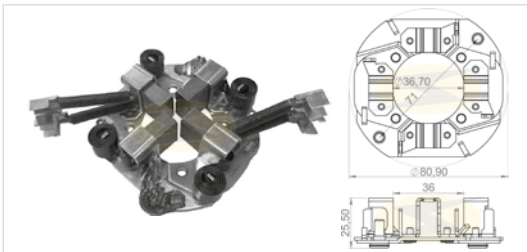

UF - 1207/4 4 escovas / brushes

Especificações / Features: 12V, Tipo / Type: OSGR - 3,1 Kw - Escova / Brush: 9 x 18 x 22 mm

(L x A x C / W x H x L) - Giro Sentido Horário / Clockwise Rotation

Original: 182318

Partida / Starter: D9R73, D9R116, D9R144, 184202, 455537, 184202

Aplicação / Application: RENAULT: TRAFIC DIESEL, VOLVO PENTA: EMBARCAÇÕES COM MOTORES DIESEL / MARINES DIESEL ENGINES: 21-42 SERIES: API MARINE #150970E, ARCO #97255, IAT, AD31A / B, AD41B, AQAD30A, AQAD31A, AQB41, AOD40A, AQAD40A, AQD41 / DP / SP, AQAD 41 / DP / SP, D40 / TD40, KAD43P, KAD43PA, KAD44P, MD 30 / TMD 30 / TAMD30, MD5C / MS2, TAMD31, TAMD41B, TDM 40 / 41, TAMD 61B, KAD 42, KAMD300, KAD300A

Valeo

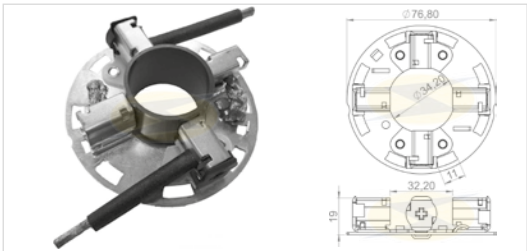

UF - 1229/4 4 escovas / brushes

Especificações / Features: 12V - Escova / Brush: 7 x 14 x 14 mm (L x A x C / W x H x L)

Original:

Partida / Starter: 432644, 455720, 0986017260, 001109250, 550.509.102, 0031512901, 0031519801, 0041518901, 0041519201, 0041519701, 0051511301, 0051516601, 5151130180, 5151130187, A0031512901, A0031519801, A0031513501, A0041514401, A0041515601, D7R1, D7R2, D7R3, D7R4, D7R5, D7R6, D7R7, D7R11, D7R19, D7R28, D7R34, D7R35, D7R43, D7R44, D7R46, D7R47, D7R48, D9R149, ND162, GXE4850

Aplicação / Application: MERCEDES-BENZ: CLASSE C, E, S, G, V, CLK, SPRINTER, UNIMOG, VIANO, VITO, VARIO

Valeo



UF - 1232/4 4 escovas / brushes

Especificações / Features: 12V, Tipo / Type: D6 / D7 Series - 0,9 Kw - 9 Dentes / Teeth, 25 mm - Escova / Brush: 3,5 / 6,5T x 10 x 15 mm (L x A x C / W x H x L) - Giro Sentido Horário / Clockwise Rotation

Original: 195253

Partida / Starter: AC713850M, D6G3, 9648644680, 9618725080, 436062, 438093, 438129, 455748, D6RA100, DGRA37, D6RA57, D6RA571, D6RA572, D7E16, D7E3, D7E5, D7E51, D7E16, D7E23, D7E5

Aplicação / Application: CITRÖEN: C3 1.6, C4 XSARA PICASSO 1.6 16V (2007→), C4 1.5 (2005→), BERLINGO 1.11 / 1.41 / 1.61, PEUGEOT: 206 1.4 / 1.6 16V (2000→), 307 1.4 / 1.6, PARTNER 1.11 / 1.41 / 1.61, RANCH 1.41, RENAULT: CLIO 1.6 16V (2000→), KANGOO 1.6 16V (K4M 2000 MOTOR / ENGINE)

Valeo

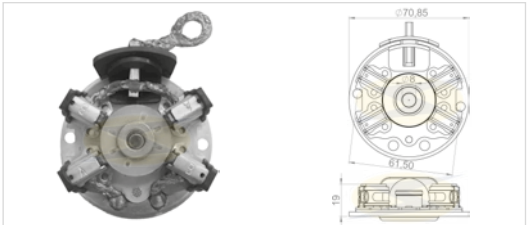

UF - 1247/4 4 escovas / brushes

Especificações / Features: 12V - Escova / Brush: 5 x 12 x 11,6 mm (L x A x C / W x H x L)

Original:

Partida / Starter: 233000799R, 7S5511000AB, 7S5511000AA, 3S6511000BA, XS6U11000AD, XS6U11000AC, FS10B1, FS10B2, FS10B3, FS10B4, 18G3 6547 CA F, BU2TA

Aplicação / Application: NISSAN: MARCH 1.0 2012>, RENAULT: CLIO, LOGAN, SANDERO 1.0 8V / 16V, FORD: COURIER - 1999 a 2013, ECOSPORT - 2003 a 2012, ESCORT - 2000 a 2002, FIESTA - 1999 a 2013, FOCUS - 2003 a 2007, KA - 1999 a 2007, NOVO KA - 2009 a 2015

Bosch

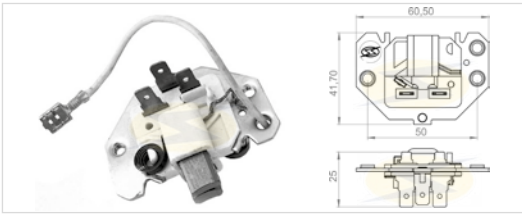

UF - 2.201/2 2 escovas / brushes

Especificações / Features: 14V, Tipo / Type: K1 - 55A - Escova / Brush: 5 x 10 x 17 mm

(L x A x C / W x H x L)

Original: 1 124 336 050

Alternador / Alternator: 9 120 080 012, 9 120 080 182, 9 120 080 183

Aplicação / Application: **AGCO:** NOVOS TRATORES, **AGRALE-DEUTZ:** 8001 - 8501 TDX, **CASE:** 2000 - 2470, 4000 - 4490, W 36, **KOMATSU:** D 30 E **MASSEY-FERGUSON:** SÉRIES MF 1000 / 3000 / 4000 / 5000 / 6000, **MAXION:** MAXION IDEAL 1175 / 9070 / 9075 / 9090 / 750 / 9150 / 9170, SÉRIE D C/ MOTOR D 229-6, **SLC:** 6000 - 6200 / 6200 TURBO / 7000 - 7200 / 7700 / TURBO, **MERCEDES-BENZ:** SÉRIES - 6T L, 8T L, 10T L, 11T L, 12T L, 13T L, 14T L, 14T LP, 15 T L, 16 T L, 17 T L, 18 T L, 20 T L, 22 T L, 23 T L, SÉRIES - 24 T, O, OF, OH, **AGRALE-DEUTZ:**

1600 D, 4200 / 4230 / 4300, M 80 / 85 / 90, TX 1600, **CASE:** W18, W 20 B, **CBT:** 1065 / 1105 / 2080 / 2105 / 8060 4X4 / 8240 / 8260 4X4, **KOMATSU:** D 50 A, **MÜLLER:** VIBRO RT 62, **MWM-DIESEL:** SÉRIE D C/ MOTOR D 229-3 / 229-4 / 229-6 / TD 229-6, **TOYOTA:** BANDEIRANTE

Bosch

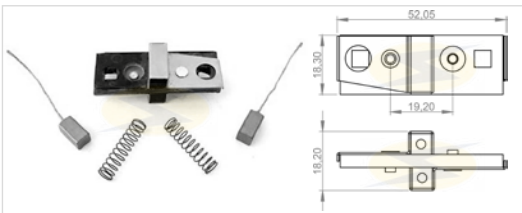

UF - 2.202/2 2 escovas / brushes

Especificações / Features: 12V - Escova / Brush: 6,3 x 6,3 x 12,7 mm (L x A x C / W x H x L)

Original: 419001

Alternador / Alternator: _____

Aplicação / Application: **FORD:** CORCEL, F1000, F4000, MAVERICK, **CATERPILLAR:** TRATORES, **CLARK:** TRATORES, **DODGE:** POLARA, **MASSEY-FERGUSON:** TRATORES, **MERCEDES-BENZ:** CAMINHÕES, **VALMET:** TRATORES

Bosch

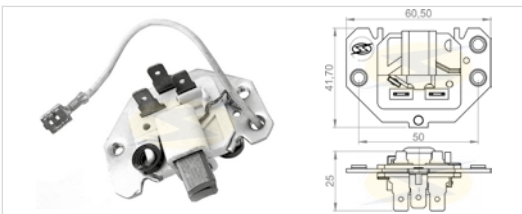

UF - 2.204/2 2 escovas / brushes

Especificações / Features: 24V - Escova / Brush: 5 x 10 x 17 mm (L x A x C / W x H x L)

Original: 1 124 336 057

Alternador / Alternator: _____

Aplicação / Application: **MWM:** MOTORES, **MERCEDES-BENZ, SCANIA, VOLVO**

Bosch

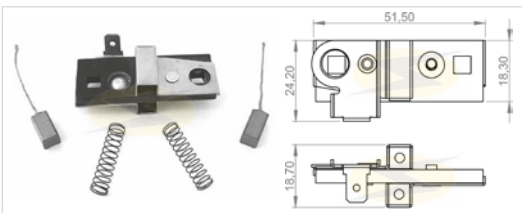

UF - 2.206/2 2 escovas / brushes

Especificações / Features: 12V - Escova / Brush: 6,3 x 6,3 x 12,7 mm (L x A x C / W x H x L)

Original: 419008

Alternador / Alternator: _____

Aplicação / Application: **FORD:** CAMINHÕES, **VOLKSWAGEN:** CAMINHÕES

Bosch

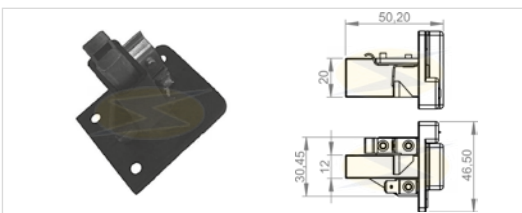

UF - 2.212/2 2 escovas / brushes

Especificações / Features: 12V - Escova / Brush: 5 x 8 x 15 mm (L x A x C / W x H x L)

Utilizado com / Used with GAUSS GA-003

Original: 9 121 080 281

Alternador / Alternator: 9 120 080 041, 9 120 080 061, 9 120 080 072, 9 120 080 090, 9 120 080 122, F 000 LD0 108

Aplicação / Application: **VOLKSWAGEN:** BRASÍLIA, KOMBI, SEDAN, FUSCA, GOL, SAVEIRO, (REFRIGERADOS A AR / AIR COOLED)

Delco

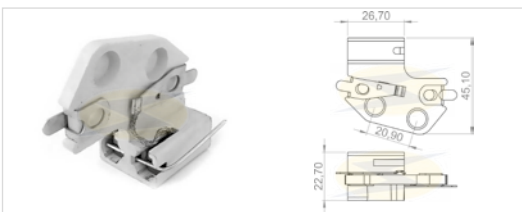

UF - 2.203/2 2 escovas / brushes

Especificações / Features: 12V - Escova / Brush: 5 x 8 x 13,2 mm (L x A x C / W x H x L)

Original: 3472316

Alternador / Alternator: _____

Aplicação / Application: **CHEVROLET-GM:** CHEVETTE (1973→), OPALA (1973→)

Delco

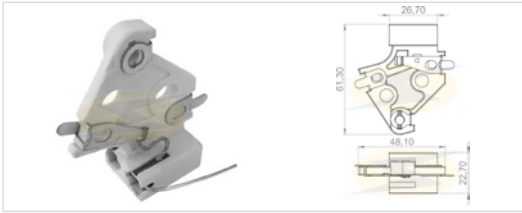

UF - 2.205/2 2 escovas / brushes

Especificações / Features: **12V** - Escova / Brush: 5 x 8 x 18 mm (L x A x C / W x H x L)

Original: 1876876, D 776, 1984462

Alternador / Alternator: 10SI, 12SI, 27SI, TYPE 100 IR, TYPE 100 EF

Aplicação / Application: **CHEVROLET-GM:** MONZA, OPALA, CARAVAN

Delco

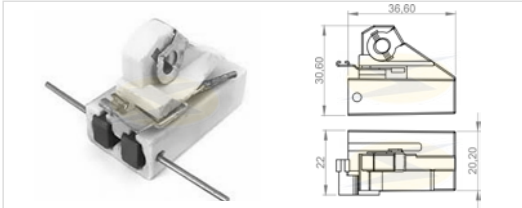

UF - 2.211/2 2 escovas / brushes

Especificações / Features: **12V** - Escova / Brush: 5 x 8 x 22 mm (L x A x C / W x H x L)

Original: 10472881, 10473364, 10490180

Alternador / Alternator: 1101218, 1101196, 1101199, 1101551, 10480125, CS121, CS130

Aplicação / Application: **CHEVROLET-GM, DAEWOO, OPEL, VAUXHALL**

Delco

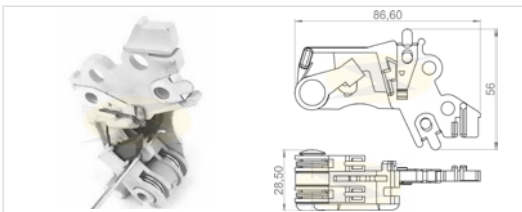

UF - 2.213/2 2 escovas / brushes

Especificações / Features: **12V/24V** - Escova / Brush: 5 x 6 x 22 mm (L x A x C / W x H x L)

Original: 1979724, 10467934

Alternador / Alternator: 19012025, 15SI, TYPE 116, 21SI, SERIES IR, SERIES EF

Aplicação / Application: **MERCEDES-BENZ**

Delco

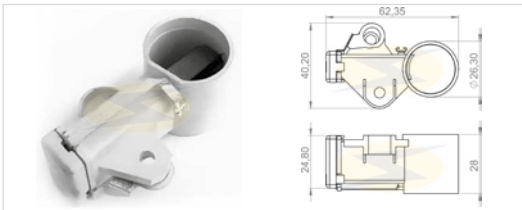

UF - 2.214/2 2 escovas / brushes

Especificações / Features: **12V** - Escova / Brush: 4,5 x 8 x 22 mm (L x A x C / W x H x L)

Original: 10475011

Alternador / Alternator: **DELCO COREANO:** 100A, CS130D, 3493947, 10479914, 1047923, 1047947, 1047955

Aplicação / Application: **CHEVROLET-GM, DAEWOO, OPEL, SAAB, VAUXHALL**

Delco

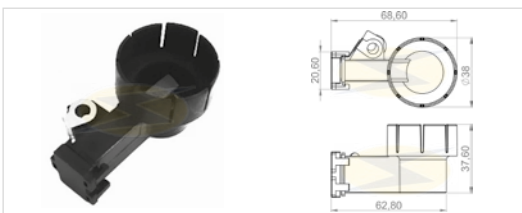

UF - 2.215/2 2 escovas / brushes

Especificações / Features: **12V** - Escova / Brush: 4,5 x 8 x 22 mm (L x A x C / W x H x L)

Original: 10475746

Alternador / Alternator: **DELCO:** CS 130D SÉRIE IR, **DELCO:** CS 130D SÉRIE IF, 10479214, 10479215, **DELPHI:** 134208

Aplicação / Application: **CHEVROLET-GM:** BLAZER, S10 VORTEC V6 4.3, **BUICK, PONTIAC, OLDSMOBILE, DAEWOO**

Delco

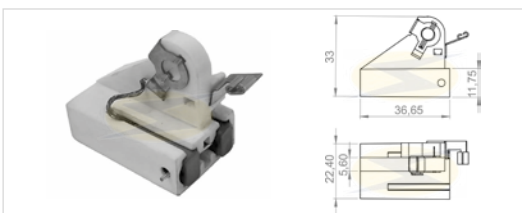

UF - 2.219/2 2 escovas / brushes

Especificações / Features: **12V**, 140A - Escova / Brush: 5 x 8 x 22 mm (L x A x C / W x H x L)

Original: 1989702

Alternador / Alternator: 10480124, 10479809, 10479817, D775, CS144 - IR SERIES, CS144 - IF SERIES

Aplicação / Application: **CHEVROLET-GM:** OMEGA 4.1 MPFI L6, SILVERADO 4.1 MPFI L6

Delco

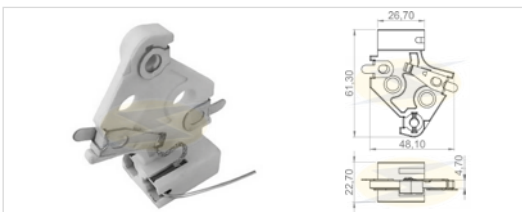

UF - 2.220/2 2 escovas / brushes

Especificações / Features: **12V**, Escova com guia de molas / Brush with guide to spring -

Escova / Brush: 5 x 8 x 18 mm (L x A x C / W x H x L)

Original: 1876873, D766

Alternador / Alternator: 27 SI, TYPE 200 SERIES IR, TYPE 200 SERIES EF

Aplicação / Application: **CHEVROLET-GM**

Denso

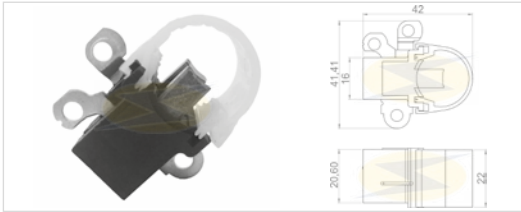

UF - 2.222/2 2 escovas / brushes

Especificações / Features: 12V - Tipo / Type: ER/IF - Escova / Brush: 5 x 7 x 15 mm

(L x A x C / W x H x U)

Original: 021620-2430

Alternador / Alternator: 121000-3000, 121000-3100, 121000-3300, 121000-3310, 121000-3330, 121000-3340, 121000-3360, 121000-3380, 121000-3390, 121000-3400, 121000-3440, 121000-3450, 121000-3452, 121000-3460, 121000-3480, 121000-3510, 121000-3520, 121000-3521, 121000-3523, 121000-3530, 121000-3531, 121000-3600, 121000-3620, 121000-3630, 121000-3650, 121000-3660, 121000-3670, 121000-3671, 121000-3710, 121000-3750, 121000-3760, 121000-3800, 121000-3810, 121000-3820, 121000-3821, 121000-3850, 121000-3851, 121000-4000, 121000-4010, 121000-4030, 121000-4040, 121000-4041, 121000-4050, 121000-4060, 121000-4070, 121000-4080,

121000-4090, 121000-4110, 121000-4130, 121000-4150, 121000-4151, 121000-4160, 121000-4161, 121000-4170, 121000-4171, 121000-4210, 121000-4211, 121000-4220, 121000-4221, 121000-4231, 121000-4232, 121000-4233, 121000-4250, 121000-4251, 121000-4270, 121000-4280, 121000-4290, 121000-4291, 121000-4300, 121000-4330, 121000-4331, 121000-4332, 121000-4350, 121000-4351, 121000-4360, 121000-4400, 121000-4440, 121000-4450, 121000-4451, 121000-4460, 121000-4470, 121000-4481, 121000-4490, 121000-4491, 121000-4520, 121000-4530, 121000-4550, 121000-4551, 121000-4560, 121000-4580, 121000-4590, 5-121000-167

Aplicação / Application: CHRYSLER: CIRRUS, DAYTONA, LEBARON, SEBRING, DODGE: CARAVAN, DAKOTA, DURANGO, RAM 1500 / 2500 / 3500, SHADOW, STRATUS, JEEP: GRAND CHEROKEE, TJ, WRANGLER, PLYMOUTH: ACCLAIM, BREEZE, SUNDANCE, VOYAGER

Denso

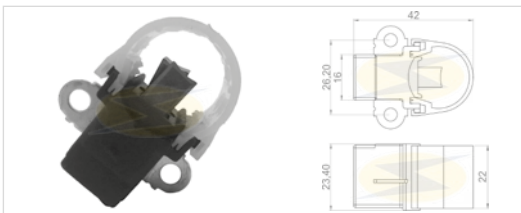

UF - 2.223/2 2 escovas / brushes

Especificações / Features: 12V - Tipo / Type: IR/IF - Escova / Brush: 5 x 7 x 15 mm

(L x A x C / W x H x U)

Original: 021620-2720, 27370-42010

Alternador / Alternator: 100211-3690, 100211-4070, 100211-4071, 100211-5350, 100211-6030, 100211-6031, 100211-6050, 100211-6051, 100211-6060, 100211-6110, 100211-6130, 100211-6131, 100211-6150, 100211-6170, 100211-6190, 100211-6270, 100211-6300, 100211-6310, 100211-6350, 100211-6360, 100211-6370, 100211-6390, 100211-6410, 100211-6420, 100211-6440, 100211-7320, 100211-7330, 100211-7860, 100211-7861, 100211-8010, 100211-8020, 100211-8030, 100211-8050, 100211-8060, 100211-8070, 100211-8100, 100211-8130, 100211-8150, 100211-8151, 100211-8190, 100211-8230, 100211-8260, 100211-8300, 100211-8320, 100211-8321, 100211-8330, 100211-8370, 100211-8371,

100211-8380, 100211-8381, 100211-8390, 100211-8391, 100211-8392, 100211-8440, 100211-8480, 100211-8530, 100211-8540, 100211-8550, 100211-8560, 100211-8570, 100211-8590, 100211-8620, 100211-8621, 100211-8622, 100211-8630, 100211-8631, 100211-8632, 100211-8640, 100211-8660, 100211-8710, 100211-8740, 100211-8750, 100211-8770, 100211-8810, 100211-8820, 100211-8830, 100211-8840, 100211-8841, 100211-8850, 100211-8860, 100211-8870, 100211-8910, 100211-8911, 100211-8980, 100211-8990, 100211-8991, 100211-9880, 101211-0690, 101211-4280, 101211-5010, 101211-5020, 101211-5030, 101211-5080, 101211-5090, 101211-5110, 101211-5150, 101211-5160, 101211-5220, 101211-5230, 101211-5240, 101211-5270, 101211-5360, 101211-5400, 101211-5410, 101211-5420, 101211-5430, 101211-5450, 101211-5460, 101211-5480, 101211-5490, 101211-5500, 101211-5540, 101211-5550, 101211-5560, 101211-5610, 101211-5620, 101211-5690, 101211-5710, 101211-5720, 101211-5850, 101211-5970, 101211-7020, 101211-7060, 101211-7070, 101211-7071, 101211-7090, 101211-7091, 101211-7120, 101211-7160, 101211-7170, 101211-7180, 101211-7220, 101211-7230, 101211-7270, 101211-7300, 101211-7301, 101211-7400, 101211-7440, 101211-7450, 101211-7520, 101211-7551, 101211-7570, 101211-7630, 101211-7633, 101211-7640, 101211-7750, 101211-7760, 101211-7761, 101211-7780, 101211-7800, 101211-7840, 101211-7850, 101211-7851, 101211-7860, 101211-7861, 101211-7880, 101211-7892, 101211-7920, 101211-7960, 101211-9010, 101211-9020, 101211-9060, 101211-9100, 101211-9110, 101211-9120, 101211-9130, 101211-9140, 101211-9150, 101211-9160, 101211-9250, 101211-9280, 101211-9310, 101211-9330, 101211-9340, 101211-9350, 101211-9410, 101211-9440, 101211-9450, 101211-9510, 101211-9580, 101211-9590, 101211-9600, 101211-9630, 101211-9710, 101211-9711, 101211-9760, 101211-9810, 101211-9860, 101211-9940, 101211-9960, 101211-9970, 102211-0400, 102211-0500, 102211-0512, 102211-0520, 102211-0590, 102211-0610, 102211-0680, 102211-0681, 102211-0770, 102211-0830, 102211-0860, 102211-0870, 102211-0981, 102211-1010, 102211-1020, 102211-1021, 102211-1040, 102211-1180, 102211-1240, 102211-1330, 102211-1331, 102211-1370, 102211-1430, 102211-1440, 102211-1620, 102211-1740, 102211-1750, 102211-1760, 102211-1770, 102211-1830, 102211-1950, 102211-1951, 102211-1960, 102211-2000, 102211-2001, 102211-2120, 102211-2230, 102211-2231, 102211-2232, 102211-2233, 102211-2340, 102211-2400, 102211-2670, 102211-2680, 102211-2690, 102211-2750, 102211-3030, 102211-3140, 102211-4050, 102211-9070, 102211-9100, 104210-8040

Aplicação / Application: ACURA: CL, BUICK: CENTURY, LESABRE, PARK AVENUE, REGAL, CHEVROLET: C1500 / 2500 / 35 / 3500, CAVALIER, CORVETTE, K1500 / 2500 / 3500, PRIZM, HONDA: ACCORD, ODYSSEY, ISUZU: OASIS, JAGUAR: S-TYPE, LEXUS: ES 300 / GS 300 / IS 300 MINI COOPER: BASE HATCHBACK 2-DOOR, LUXURY HATCHBACK 2-DOOR, S HATCHBACK 2-DOOR, SPORT HATCHBACK 2-DOOR, CHILI HATCHBACK 2-DOOR, PEPPER HATCHBACK 2-DOOR, S CHILI HATCHBACK 2-DOOR, S HOT CHILI HATCHBACK 2-DOOR, S SALT HATCHBACK 2-DOOR, SALT HATCHBACK 2-DOOR, BASE CONVERTIBLE 2-DOOR, CHILI CONVERTIBLE 2-DOOR, S CONVERTIBLE 2-DOOR, CHECKMATE HATCHBACK 2-DOOR, PARK LANE HATCHBACK 2-DOOR, S CHECKMATE HATCHBACK 2-DOOR, S PARK LANE HATCHBACK 2-DOOR, SEVEN HATCHBACK 2-DOOR, CLUBMAN WAGON 3-DOOR, JOHN COOPER WORKS CONVERTIBLE 2-DOOR, S CLUBMAN HATCHBACK 3-DOOR, S CLUBMAN WAGON 3-DOOR, S SIDEWALK HATCHBACK 2-DOOR, JOHN COOPER WORKS CLUBMAN WAGON 3-DOOR, JOHN COOPER WORKS HATCHBACK 2-DOOR, PONTIAC: BONEVILLE, FIREBIRD, GRAND AM, GRAND PROX, SUNFIRE, TRANS SPORT, SCION: XB SUZUKI: AERIO TOYOTA: CAMRY, COROLLA, ECHO, SOLARA, SUPRA

Denso

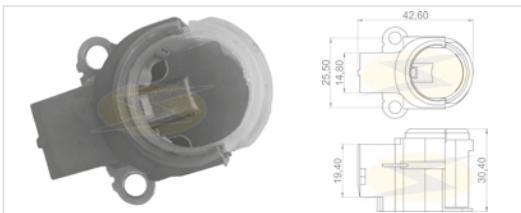

UF - 2.224/2 2 escovas / brushes

Especificações / Features: 12V - Tipo / Type: IR/IF, EF / IR - Escova / Brush: 5 x 7 x 15 mm

(L x A x C / W x H x U)

Original: 021620-3020, 021620-3030

Alternador / Alternator: 210-0511, 210-0516, 210-0531, 210-0536, 210-0544, 210-0546, 210-0547, 210-0549, 210-0550, 210-0573, 210-0576, 210-0577, 210-0581, 210-0608, 210-0609, 210-0613, 210-0614, 210-0631, 210-0633, 210-0638, 210-0654, 210-0656, 210-0660, 210-0666, 210-0667, 210-0669, 210-0695, 210-0704, DAN952, DAN983, 9764219-377, 104210-3191, 104210-3290, 104210-3291, 104210-3292, 104210-3293, 104210-3320, 104210-3650, 104210-3651, 104210-3652, 104210-3770, 104210-3780, 104210-3880, 104210-3890, 104210-4140, 104210-4220, 104210-4230, 104210-4350, 104210-4360, 104210-4410, 104210-4420, 104210-4430, 104210-4470, 104210-4471,

104210-4571, 104210-4573, 104210-4700, 104210-4730, 104210-4731, 104210-4732, 104210-4790, 104210-4990, 104210-5070, 104210-5330, 104210-5630, 104210-6181, 104210-9341, 121000-2520, 421000-0060, 421000-0061, 421000-0062, 421000-0222, 421000-0223, 421000-0225, 421000-0370, 421000-0371, 421000-0470, 421000-0492, 421000-0493, 5-121000-252

Aplicação / Application: BUICK: ALLURE, ENCLAVE, LACROSSE, LESABRE, LUCERNE, CADILLAC: SRX, STS, CHEVROLET: COBALT, EQUINOX, HHR, IMPALA, MALIBU, MONTE CARLO, TRAVERSE, CHRYSLER: SEBRING, TOWN & COUNTRY, DODGE: AVENGER, CARAVAN, GRAND CARAVAN, STRATUS, FORD: EXPEDITION, GMC: ACADIA, LEXUS: GS 300 / 350, IS 250 / 350, RS 330 / 350, LINCOLN: NAVIGATOR, PONTIAC: BONNEVILLE, G5, GRAND PRIX, PURSUIT, TORRENT, VIBE, SATURN: AURA, ION, OUTLOOK, VUE, SCION: TC, XD TOYOTA: 4 RUNNER, AVALON, CAMRY, COROLLA, FJ CRUISER, HIGHLANDER, HILUX 2.5 (PIT-BULL) MATRIX, RAV4, SIENNA, TACOMA, TUNDRA, VENZA, VOLVO: C70, S40

Denso

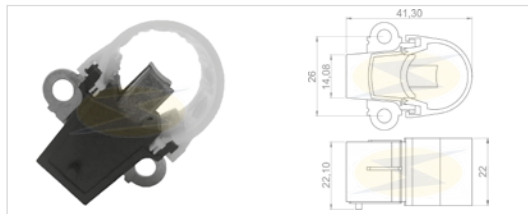

UF - 2.225/2

2 escovas / brushes

Especificações / Features: **12V** - Tipo / Type: **IR/IF, EF / IR** - Escova / Brush: 5 x 7 x 15 mm

(L x A x C / W x H x L)

Original: 021620-3001

Alternador / Alternator: 04210-306, 104210-307, 421000-001, 421000-002, 421000-003, 421000-004, 421000-006, 421000-010, 421000-011, 421000-012, 104210-3030, 104210-3031, 104210-3032, 104210-3040, 104210-3041, 104210-3042, 104210-3043, 104210-3060, 104210-3070, 104210-3090, 104210-3091, 104210-3092, 104210-3120, 104210-3121, 104210-3122, 104210-3140, 104210-3141, 104210-3280, 104210-3440, 104210-3441, 104210-3460, 104210-3470, 104210-3471, 421000-0011, 421000-0012, 421000-0013, 421000-0021, 421000-0022, 421000-0023, 421000-0024, 421000-0025, 421000-0026, 421000-0027, 421000-0028, 421000-0030, 421000-0040, 421000-0041,

421000-0042, 421000-0043, 421000-0051, 421000-0100, 421000-0103, 421000-0111, 421000-0113, 421000-0120, 421000-0121, 421000-0122, 421000-0150, 421000-0151, 421000-0180, 421000-0190, 421000-0191, 5-121000-348

Aplicação / Application: **ACURA:** CSX, TSX, **HONDA:** ACCORD, CIVIC, CR-V, ELEMENT, **LEXUS:** LS 430, SC 430, **TOYOTA:** 4 RUNNER, HIGHLANDER

Denso

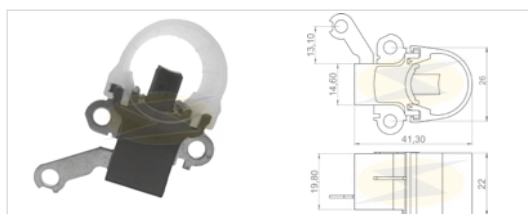

UF - 2.226/2

2 escovas / brushes

Especificações / Features: **12V** - Tipo / Type: **IR/IF** - Escova / Brush: 5 x 7 x 15 mm

(L x A x C / W x H x L)

Original: 021620-3100

Alternador / Alternator: 102211-3102

Aplicação / Application: **HYUNDAI:** ENTOURAGE 3.8L 2007-2009, AZERA 3.8L 2008, SANTA FE 2.7L 2007-2008, SANTA FÉ 3.3L 2007-2008, SONTATA 3.3L 2006-2008, VERACRUZ 3.8L 2007-2010, **KIA:** SORENTO 3.3L 2008, SORENTO 3.8L 2007-2008, SEDONA 3.8L 2006-2009

Ford / Motorcraft

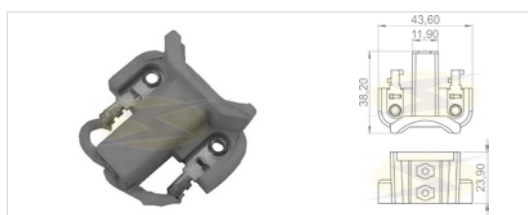

UF - 2.216/2

2 escovas / brushes

Especificações / Features: **12V** - Escova / Brush: 4 x 7,5 x 18 mm (L x A x C / W x H x L)

Original: F1DZ-10347-A

Alternador / Alternator: GB320, IR 3G SERIES, IF 3G SERIES, 2C2U - 10300-BB, F6AU-10300-AA, F6AU-10300-AB

Aplicação / Application: **FORD:** F250, F-350, F-1000, CONTINENTAL, COUGAR, ESCORT, EXPLORER, SABLE, LINCOLN, MERCURY, RANGER, TAURUS, TEMPO, THUNDERBIRD, TRACER, TOPAZ, TOWN CAR

Ford / Motorcraft

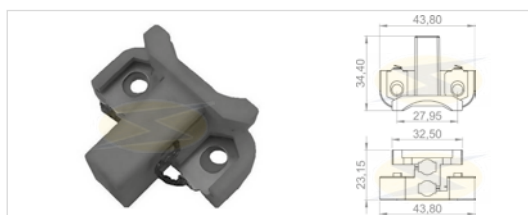

UF - 2.217/2

2 escovas / brushes

Especificações / Features: **12V** - Escova / Brush: 4 x 7,5 x 18,5 mm (L x A x C / W x H x L)

Original: E9PU-10320-AA

Alternador / Alternator: E9DF-10300-CA, F0DF-10300-AA, F1VU-10300-BB, 3G SERIES IR, 3G SERIES IF

Aplicação / Application: **FORD:** F250, F-350, F-1000, BRONCO 3.6, CONTINENTAL, COUGAR, ESCORT, EXPLORER, SABLE, LINCOLN, MERCURY, RANGER, TAURUS, TEMPO, THUNDERBIRD, TRACER, TOPAZ, TOWN CAR

Ford / Motorcraft

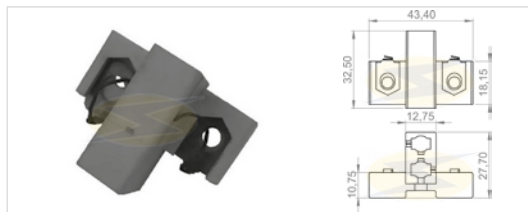

UF - 2.218/2

2 escovas / brushes

Especificações / Features: **12V** - Escova / Brush: 4 x 7,5 x 12 mm (L x A x C / W x H x L)

Original: E43Z-10320-A, GC-402

Alternador / Alternator: E43F-10300-EA, E43F-10300-PA, E43F-10300-RA, E43Z-10346-D, E53F-10300AA, E53F-10300BA, E53F-10300DA, E53F-10300IR, E53F-10300EF

Aplicação / Application: **FORD:** BRONCO 2.6, **MERCURY**

Ford / Visteon



UF - 2.221/2

2 escovas / brushes

Especificações / Features: **12V** - Escova / Brush: 4,5 x 8,3 x 16,3 mm (L x A x C / W x H x L)

Utilizado com / Used with GAUSS GA-350 e 360

Original:

Alternador / Alternator: RC28 SERIES

Aplicação / Application: **FORD:** FIESTA, FOCUS, KA, ECOSPORT, COURIER

Prestolite / Delphi

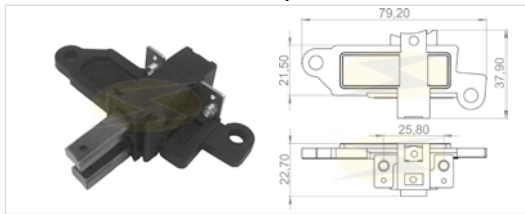

UF - 2.207/2 2 escovas / brushes

Especificações / Features: 12V - Escova / Brush: 5 x 8 x 26 mm (L x A x C / W x H x L)

Original: 352.14.128

Alternador / Alternator: 352.13.950, 352.13.955, 352.14.085, 352.14.095, 352.14.190, 352.14.445, 12V 80>90A

Aplicação / Application: PEUGEOT, RENAULT: R19 1.6, VOLKSWAGEN

Prestolite / Delphi

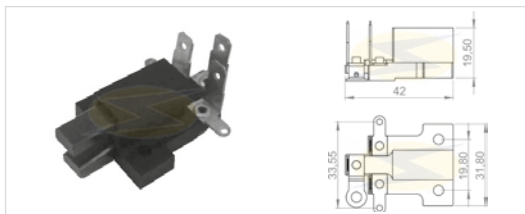

UF - 2.208/2 2 escovas / brushes

Especificações / Features: 12V - Escova / Brush: 4,5 x 8 x 16,5 mm (L x A x C / W x H x L)

Original: 352.12.715

Alternador / Alternator: 352 13 850 12V 70A

Aplicação / Application: MERCEDES-BENZ

Prestolite / Delphi

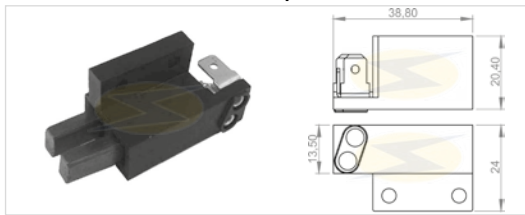

UF - 2.209/2 2 escovas / brushes

Especificações / Features: 24V - Escova / Brush: 4,5 x 8 x 18,5 mm (L x A x C / W x H x L)

Original: 352.13.010

Alternador / Alternator: 352.13.670, 352.13.680, 352.13.690, 352.13.845, 352.13.865, 352.13.970, 352.14.130, 352.14.170, 352.14.560, MB1 2100R, MB24055R, MB24090R, SC 12100R, SC 24055R, SC 24090R

Aplicação / Application: FORD, MERCEDES-BENZ, PERKINS, RENAULT, SCANIA, VOLKSWAGEN

Prestolite / Delphi

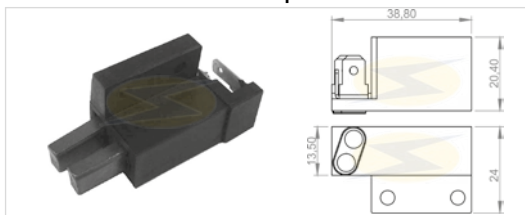

UF - 2.210/2 2 escovas / brushes

Especificações / Features: 12V / 24V - Escova / Brush: 4,5 x 8 x 18,5 mm (L x A x C / W x H x L)

Original: 352.13.406

Alternador / Alternator: 352.13.685, 352.13.690, 352.13.725, 352.13.730, 352.14.305, M02409R 12V 55 > 90A, M02409R 24V 55 > 90A

Aplicação / Application: DEUTZ, EL DETALLE, FORD, PERKINS, RENAULT: TRAFIC C/ AR T 352, 6.354 DIESEL, R18 2.0 / 2.2, R21 2.1, VOLKSWAGEN



UNIFAP.com.br

Diversos

UF-6.605/4 4 escovas / brushes

Especificações / Features: Escova / Brush: 7 x 8 x 17 mm (L x A x C / W x H x L), s/ Supressor ruído / Without noise suppressor

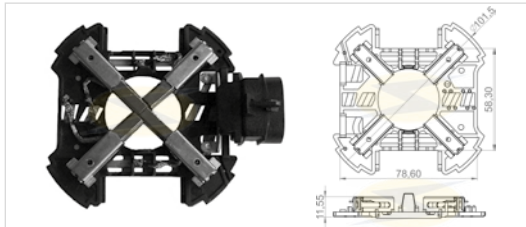

Original: _____

Motor / Motor: _____

Aplicação / Application: **RENAULT:** KANGOO, 9 A 19, **PEUGEOT:** 405, 306, 205, **FIAT:** PALIO, SIENA, UNO, DUNA, **FORD:** FIESTA, ESCORT, SIERRA, FOCUS

Diversos

UF-6.606/4 4 escovas / brushes

Especificações / Features: Escova / Brush: 7 x 8 x 17 mm (L x A x C / W x H x L), c/ Supressor ruído / With noise suppressor

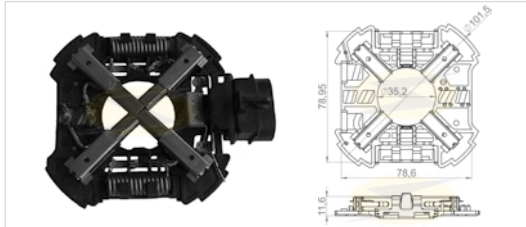

Original: _____

Motor / Motor: _____

Aplicação / Application: **RENAULT:** CANGOO, 9 A 19, **PEUGEOT:** 405, 306, 205, **FIAT:** PALIO, SIENA, UNO, TEMPRA, TIPO, DUNA, **FORD:** FIESTA, ESCORT, SIERRA, FOCUS 1.8L, **GM:** MERIVA

Diversos

UF-6.607/4 4 escovas / brushes

Especificações / Features: Escova / Brush: 7 x 8 x 17 mm (L x A x C / W x H x L)

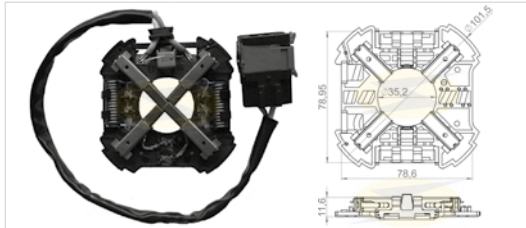

Original: _____

Motor / Motor: _____

Aplicação / Application: **RENAULT, PEUGEOT, FIAT, FORD**

Diversos

UF-6.608/4 4 escovas / brushes

Especificações / Features: Escova / Brush: 7 x 8 x 17 mm (L x A x C / W x H x L)

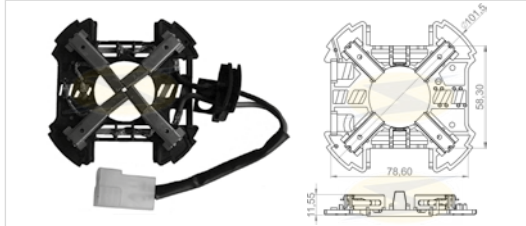

Original: _____

Motor / Motor: _____

Aplicação / Application: **RENAULT:** 19

Diversos

UF-6.609/4 4 escovas / brushes

Especificações / Features: Escova / Brush: 7 x 8 x 17 mm (L x A x C / W x H x L)

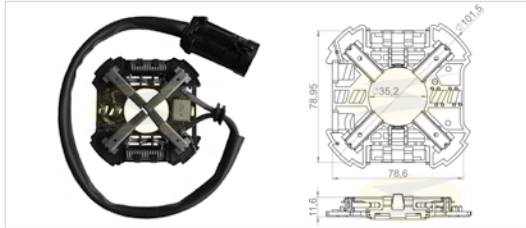

Original: _____

Motor / Motor: _____

Aplicação / Application: **FIAT:** PALIO

Diversos

UF-6.610/4 4 escovas / brushes

Especificações / Features: Escova / Brush: 7 x 8 x 17 mm (L x A x C / W x H x L)

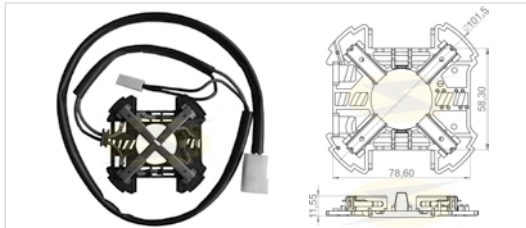

Original: _____

Motor / Motor: _____

Aplicação / Application: **FIAT:** UNO (DIESEL), DUNA (GASOLINA)

Diversos

UF - 6.611/4 4 escovas / brushes **Especificações / Features:** Escova / Brush: 7 x 8 x 17 mm (L x A x C / W x H x L)

Original: _____

Motor / Motor: _____

Aplicação / Application: **PEUGEOT: 405**

Porta Escovas Para Limpadores de Para Brisa
 Brush holders for Windshield Wiper

Bosch

UF - 6.601/3 3 escovas / brushes **Especificações / Features:** 12V, Tipo / Type: CHP - Escova / Brush: 6,3 x 6,3 x 12 mm (L x A x C / W x H x L)

Original: 9 390 082 022

Aplicação / Application: **CHEVROLET-GM, FIAT, MERCEDES-BENZ, SCANIA, VOLKSWAGEN: FUSCA 1.3 / 1.5**

Bosch

UF - 6.602/3 3 escovas / brushes **Especificações / Features:** 12V Escova / Brush: 4,5 x 6 x 10,5 mm (L x A x C / W x H x L)

Original: 9 390 083 018

Aplicação / Application: **CHEVROLET-GM, FIAT, FORD, VOLKSWAGEN**

Delco

UF - 6.603/3 3 escovas / brushes **Especificações / Features:** 12V Escova / Brush: 5 x 5 x 11,5 mm (L x A x C / W x H x L)

Original: _____

Aplicação / Application: **CHEVROLET-GM: D-20, MONZA, OPALA**

Porta Escovas Para Direção Elétrica
 Brush holders for Electric Power Steering Wheel Pump

Valeo

UF - 6.612/4 4 escovas / brushes **Especificações / Features:** Escova / Brush: 6 x 12,5 x 20 mm (L x A x C / W x H x L)

Original: _____

Motor / Motor: **DIREÇÃO ELÉTRICA / ELECTRIC POWER STEERING WHEEL PUMP**

Aplicação / Application: **CITROEN: SAXO, PEUGEOT: 106, RENAULT: KANGOO, SCENIC**

Porta Escovas Para Levantador de Vidro
 Brush holder for Window Lift Motor

Mabuchi/Carto

UF - 6.604/2 2 escovas / brushes **Especificações / Features:** 12V

Original: _____

Aplicação / Application: **UNIVERSAL: PARA LADO DIREITO OU ESQUERDO, COM E SEM CONECTOR / RIGHT OR LEFT SIDE, WITH AND WITHOUT CONNECTOR**

Honda

UF - 9.901/2 2 escovas / brushes

Especificações / Features: 12V, Escova / Brush: 6 x 10 x 13,5 mm (L x A x C / W x H x L)

Original: 31206

Partida / Starter: 901QTY1M9T11

Aplicação / Application: HONDA: CBX AERO 150, CBX 200, CG TITAN 125, NX 150, NX 200, SAHARA 350, XR 200



Honda / Yamaha

UF - 9.902/4 4 escovas / brushes

Especificações / Features: 12V, Escova / Brush: 5 x 10 x 12,5 mm (L x A x C / W x H x L)

Original: 31206 MMS 008, IVJ 81844 000, YAMAHA: 6M6-81840-10

Partida / Starter: 31200MJO006, ZUG 8184000

Aplicação / Application: HONDA: HONDA 750 - REPARO 31201 ICG7 000, YAMAHA: TENERÉ 1 FAROL - REP. 3 AJ 81801 00, XV 250 - VIRAGO, YBR, JET-SKI / WATER CRAFT (TODA LINHA / ALL LINE WAVE RUNNER)

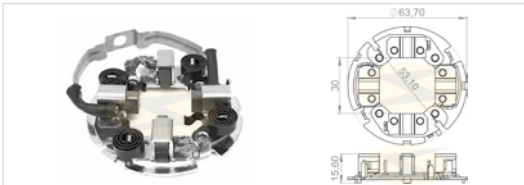

Yamaha

UF - 9.903/2 2 escovas / brushes

Especificações / Features: 12V, Escova / Brush: 6 x 9,5 x 10 mm (L x A x C / W x H x L)

Original:

Partida / Starter:

Aplicação / Application: YAMAHA: YBR



Kawasaki

UF - 9.904/4 4 escovas / brushes

Especificações / Features: 12V, Escova / Brush: 5 x 10 x 12,5 mm (L x A x C / W x H x L)

Base 3mm maior que UF-9.902/4 | Base 3mm bigger than UF-9.902/4

Original:

Partida / Starter:

Aplicação / Application: KAWASAKI: JET-SKI / WATER CRAFT, MOTO 900 / 1100 CC, YAMAHA: XT 600

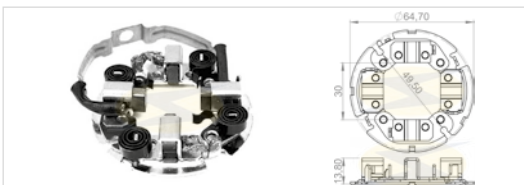

Honda

UF - 9.905/2 2 escovas / brushes

Especificações / Features: 12V, Escova / Brush: 6 x 7,5 x 8 mm (L x A x C / W x H x L)

Original: 9 390 083 018

Partida / Starter:

Aplicação / Application: HONDA: CG 150



Honda

UF - 9.906/2 2 escovas / brushes

Especificações / Features: 12V, Escova / Brush: 6 x 7,5 x 8 mm (L x A x C / W x H x L)

Original:

Partida / Starter:

Aplicação / Application: HONDA: BIZ 100



Nippondenso

UF - 9.907/2 2 escovas / brushes

Especificações / Features: 12V, Escova / Brush: 6 x 9 x 12 mm (L x A x C / W x H x L)

Original: 028510-0632

Partida / Starter: NIPPONDENSO 028000-9281, 028000-8410, 128000- 2760, 128000-4242, 128000-4630, 128000-4861, 128000-5142, 228000-2780, 228000-4550, 228000-4560

Aplicação / Application: BOMBARDIER SEA-DOO: JET SKI / WATER CRAFT, KAWASAKI



Bosch **UF-3301** Original: 409031095

Dinamo / Dynamo: (WAPSA)

Aplicação / Application: **VOLKSWAGEN: SEDAN, BRASÍLIA E KOMBI**

1 canal / groove

Bosch **UF-3302** Original: 4 090 031 096

Dinamo / Dynamo: (WAPSA)

Aplicação / Application: **VOLKSWAGEN: SEDAN, BRASÍLIA E KOMBI**

1 canal / groove

Bosch **UF-3303** Original: 404 053, 404 059, 9 121 450 566, 9 121 450 940

Alternador / Alternator: **WAPSA: 9 121 450 014**

Aplicação / Application: **VOLKSWAGEN: CAMINHÕES 13210 / 15210 / 22210 - C/ MOTOR CUMMINS, SÉRIE C EXPORTAÇÃO, CAMINHÕES 16170 / 14170 / 16210 - C/ CUMMINS SÉRIE C**

8 canais / grooves

Bosch **UF-3305** Original: 1 126 601 524

Alternador / Alternator: 0 120 335 010, 0 120 485 046, 0 123 310 001, 0 123 310 002, 0 123 310 007, 0 123 310 019, 0 123 310 020, 0 123 315 001, 0 123 315 002, 0 123 320 001, 0 123 320 002, 0 123 320 003, 0 123 320 006, 0 123 320 007, 0 123 320 009, 0 123 325 005, 0 123 340 001, 0 123 340 002, 0 123 340 003, 0 123 505 005, 0 123 505 011, 0 123 510 001, 0 123 510 006, 0 123 510 008, 0 123 510 009, 0 123 510 054, 0 123 515 011, 0 123 515 014, 0 123 540 001, 0 124 325 043, 0 124 325 061

Aplicação / Application: **AUDI: CABRIO 1.9 TDI, 801.9 TDI, A6 1.9 TDI, FORD: GALAXI 1.9 TDI, MERCEDES-BENZ: C180T 1.8, ALTERNADOR KC (R) 14V 90A, SEAT: ALHAMBRA 2.0 / 1.9, AROSA 1.0 / 1.4, CITY GOLF 1.6, CORDOBA 1.4 / 1.6 / 1.8 / 1.9 / 2.0, IBIZA 1.9 / 1.8 / 1.6 / 1.4 / 2.0, INCA 1.4 / 1.6 / 1.9, TOLEDO 2.0 / 1.9 / 1.8 / 1.6, SKODA: FELICIA 1.6 MPFI, PICK-UP 1.6 MPFI, VOLKSWAGEN: CALIFORNIA 1.9 / 2.5 / 2.0, CADDY 1.4 / 1.6 / 1.6, PICK-UP / 1.9 SDI, CARAVELLE 1.9 / 2.5 / 2.0 / 1.9 TURBO, CORRADO 2.0, EUROVAN 2.5, GOL 1.0 MI, GOLF CABRIOLET 1.9 / 1.8 / 1.6 / 2.0 / 1.9 TDI, GOLF III 1.4 / 1.6 / 1.8 / 1.9 / 2.0 / TDI / VARIANT / SYNCRO / TURBO, JETTA 1.8 / 1.9 / 2.0 TDI, MULTIVAN 1.9 / 2.0 / D / TURBO, PARATI 1.0 MI 16V (1996→1997), PASSAT 1.6 / 1.8 / 1.9 / 2.0 / D / SYNCRO / TDI, POLO 1.0 / 1.3 / 1.4 / 1.6 / 1.8 / 1.9 / CLASSIC / 1.05, POLO VARIANT 1.4 / 1.6 / 1.9 / TDI / CLASSIC, SHARAN 1.9 / 2.0 / TDI, TRANSPORTER 1.9 / 2.0 / 2.5 / SYNCRO, VENTO 1.4 / 1.6 / 1.8 / 1.9 / 2.0 / SDI / TDI / TURBO**

6 canais / grooves

Bosch **UF-3304** Original: 465 145

Alternador / Alternator: (WAPSA)

Aplicação / Application: **VOLVO: CAMINHÕES E ÔNIBUS**

1 canal / groove

Bosch **UF-3306** Original: 9 123 080 070

Alternador / Alternator: 9 000 083 068, 9 120 080 212, 9 120 080 226, 9 120 080 230, F 000 LD0 100, F 000 LD0 102, F 000 LD0 114, F 000 LD0 115

Aplicação / Application: **CHEVROLET-GM: S10 2.5 C/ MOTOR MAXION, ALTERNADOR K1 (R) 14V 30, 85A, FORD: F1000 HSD 2.5 C/ MOTOR MAXION, F1000 T 4.0, RANGER 2.5 C/ MOTOR MWM ALTERNADOR K1 (R) 14V 28 70A, MERCEDES-BENZ: SPRINTER 2.5, ANO (09/1996) C/ MOTOR OM 014A, ALTERNADOR K1(R) 14V 30, 85A**

6 canais / grooves

Bosch **UF-3307** Original: 9 123 080 009

Alternador / Alternator: 9 120 080 500, F 000 LD0 500

Aplicação / Application: **CHEVROLET-GM: CORSA 1.0**

1 canal / groove

Bosch **UF-3308** Original: 9 121 080 137

Alternador / Alternator: 9 120 080 020, 9 120 080 058, 9 120 080 084, 9 120 080 101, 9 120 080 104, 9 120 080 112, 9 120 080 126, 9 120 080 159, 9 120 080 166, 9 120 080 181, 9 120 080 183

Aplicação / Application: **AGRALE-DEUTZ: CAMINHÕES - TX1600, TRATORES - 4200 / 440 / 4400, CASE: PÁ CAR-**

1 canal / groove

REGADEIRA - W18 / W20, CBT: TRATORES - 1065 / 1105 / 2080 / 2105 / 2600, CLARK: PÁ CARREGADEIRA - MICHIGAN 55A / 65R / 75III, KOMATSU: TRATOR ESTEIRA D30E / D50A / D50P, MASSEY-FERGUSON: COLHEITADEIRA / COMBINE, MOTOR INDUSTRIAL, TRATORES, MERCEDES-BENZ: CAMINHÕES, MICRO-ÔNIBUS, ÔNIBUS, CHASSI P/ ÔNIBUS, MOTORES INDUSTRIAL E MARÍTIMO SÉRIE OM

Bosch **UF-3309** Original: 9 121 080 151

Alternador / Alternator: 9 120 080 022, 9 120 080 091, 9 120 080 102, 9 120 080 119, 9 120 080 140, 9 120 080 160, 9 120 080 183

Aplicação / Application: **MASSEY-FERGUSON, MERCEDES-BENZ**

2 canais / grooves

Bosch **UF-3310** Original: 9 121 080 179

Alternador / Alternator: 9 120 080 031, 9 120 080 083, 9 120 080 113, 9 120 080 182

Aplicação / Application: **MASSEY-FERGUSON: COLHEITADEIRA / COMBINE - MF 5650, MERCEDES-BENZ: CHASSI P/ ÔNIBUS - OF1113 / 1313 / 1316, OH 1113 / 1313 / 1316 / 1318 / 1419 / 1517, ÔNIBUS - O364 / O365**

2 canais / grooves

Bosch

UF-3315

Original: 9 121 080 897

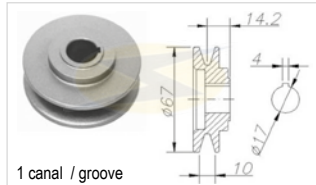

1 canal / groove

Alternador / Alternator: 9 120 080 096, 9 120 080 098, 9 120 080 169

Aplicação / Application: CHEVROLET-GM

Bosch

UF-3318

Original: 404 049, 9 121 450 506

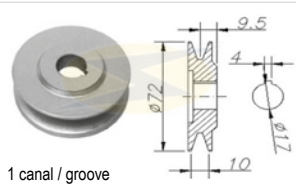

1 canal / groove

Alternador / Alternator: WAPSA

Aplicação / Application: FORD: DEL REY - C/ AR CONDICIONADO E DIREÇÃO HIDRÁULICA ATÉ (06/1987) (14V 55A), ESCORT - TODOS

Bosch

UF-3319

Original: 404 025, 9 121 450 510

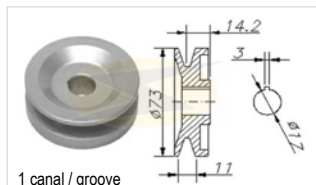

1 canal / groove

Alternador / Alternator: WAPSA

Aplicação / Application: AGRALE: MOTOR ESTACIONÁRIO - M790, TRATORES - T4100 / T4200, FORD: CAMINHÕES - F100 / F350 / F600 À GASOLINA, BELINA II, CORCEL II, DEL REY, GALAXIE, JEEP, LANDAU, LTD, MAVERICK, PAMPA, PICK-UP, RURAL, SCALA

Bosch

UF-3320

Original: 404 019, 9 121 450 490

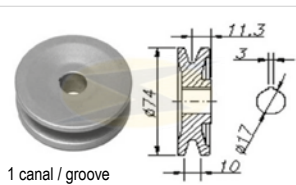

1 canal / groove

Alternador / Alternator: WAPSA

Aplicação / Application: FORD: CAMINHÕES - F1000 / F11000 / F13000 / F14000 / F19000 / F2000 / F22000 / F4000 - TODOS C/ MOTOR MWM 4 E 6 CIL

Bosch

UF-3321

Original: 404 043, 9 121 450 502

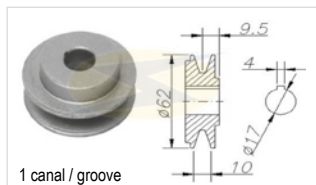

1 canal / groove

Alternador / Alternator: WAPSA

Aplicação / Application: FORD: DEL REY - C/ AR CONDICIONADO, ESCORT - GHIA / GL / GLS / XR3 - TODOS (→07/1986)

Bosch

UF-3322

Original:

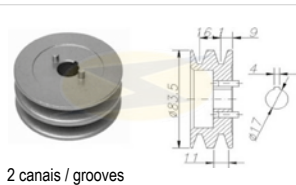

2 canais / grooves

Alternador / Alternator: 9 121 080 254

Aplicação / Application: FIAT: CAMINHÕES - 180 / 210CM (→11/1975)

Bosch

UF-3323

Original: 9 121 080 808

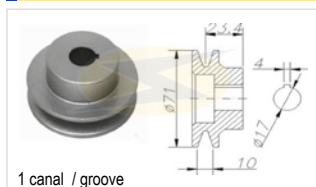

1 canal / groove

Alternador / Alternator: 9 120 080 089, 9 120 080 120, 9 120 080 221

Aplicação / Application: FIAT: FIAT 147, FIORINO (→09/1979)

Bosch

UF-3324

Original: 9 121 080 127

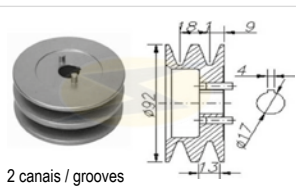

2 canais / grooves

Alternador / Alternator: 9 120 080 062, 9 120 080 144

Aplicação / Application: MASSEY-FERGUSON: TRATOR - MF4780 C/ MOTOR SCANIA DN 11, SCANIA: CAMINHÕES - L110 / 111 / LK140 / 141 / LKS140 / 141 / LS110 / 111 / LT110 / 111 / LTS110 / 111 / T112M, ÔNIBUS - B111

/ B1115

Bosch

UF-3325

Original: 1 126 600 488

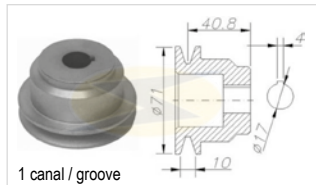

1 canal / groove

Alternador / Alternator:

Aplicação / Application: VOLKSWAGEN: GOL - CL / GL / GT / GTI / GTS / KOMBI - 1.6 A DIESEL, PARATI - CL / GL / GLS, PASSAT - 1.5 / 1.6 / GTS 1.8, QUANTUM - CL / GL / GLS, SANTANA - CL / GL / LS

Bosch

UF-3326

Original: 404 023, 9 121 450 492

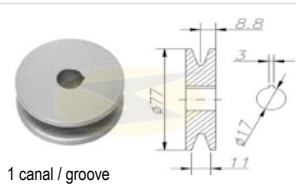

1 canal / groove

Alternador / Alternator: WAPSA

Aplicação / Application: VOLKSWAGEN: CAMINHÕES: E11 / E13 / E21 / VW 6.140 - A ÀLCOOL, DODGE: CAMINHÕES - D100 / D400 / D700 / D900, CHARGER / DART SE / GRAN GROUP / RT / SEDAN

Bosch

UF-3327

Original: 404 026, 9 121 450 499

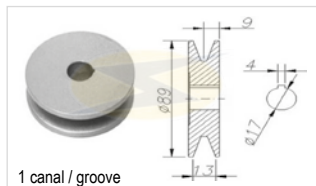

1 canal / groove

Alternador / Alternator: WAPSA

Aplicação / Application: FORD: TRATORES 4610 / 5610 / 6610 / 7610 E OUTROS

Bosch

UF-3328

Original: 9 101 080 024

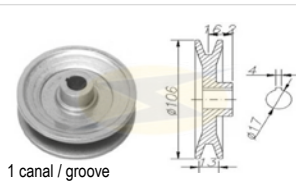

1 canal / groove

Dinamo / Dynamo: WAPSA

Aplicação / Application: MASSEY-FERGUSON: TRATORES MF50X, MF55X, MF65R, MF65X, MF85X, MF95, MF95I

Bosch **UF-3329** Original: 116019

Alternador / Alternator: **WAPSA**

Aplicação / Application: **MASSEY-FERGUSON:** COLHEITADEIRA / COMBINE MF220, TRATORES MF235, MF250, MF252, MF265, MF275, MF285, MF290, MF50X, MF55X, MF65X, MF95I, MF95X

1 canal / groove

Bosch **UF-3330** Original: 404 029, 9 121 450 494

Alternador / Alternator: **WAPSA**

Aplicação / Application: **CLARK:** PÁ-CARREG. MINI BOB
CAT. MASSEY-FERGUSON: TRATORES - MF235 / MF250 / MF265 / MF275 / MF285 / MF290 / MF290 (ÁLCOOL) / MF290RA (MOT. PERKINS AE-4.236) / MF85X / MF95X - TDS C/ ALT. WAPSA (07/1978→), **MERCEDES:** CAMINHÕES, MICRO-ÔNIBUS, MOTOR MARÍTIMO, ÔNIBUS-TDS C/ MOTORES OM 314 / 321 / 326 / 352 / 352A / 355-6 / 355-S

1 canal / groove

Bosch **UF-3331** Original: 404 037, 9 121 450 500

Alternador / Alternator: **WAPSA**

Aplicação / Application: **MASSEY-FERGUSON:** TRATORES - MF296

2 canais / grooves

Bosch **UF-3332** Original: 9 121 080 399

Alternador / Alternator: 9 120 080 045, 9 120 080 057, 9 120 080 107

Aplicação / Application: **VALMET:** TRATOR - 110ID / 621D / 651D / 851D / 118 / 138/4 / 88 / 68

1 canal / groove

Bosch **UF-3336** Original: 9 122 080 236

Alternador / Alternator: _____

Aplicação / Application: **FIAT:** ELBA - 1.6, PRÊMIO - 14V 22, 55A, UNO - 14V 23, 55A

1 canal / groove

Bosch **UF-3337** Original: 9 122 080 702

Alternador / Alternator: 9 120 080 169, 9 120 080 180, 9 120 080 203

Aplicação / Application: **CHEVROLET-GM:** IPANEMA 1.8, KADETT 1.8 / 2.0 C/ AR CONDICIONADO, MONZA - 1.8 / 2.0 / 2.0I

1 canal / groove

Bosch **UF-3338** Original: 9 122 080 409

Alternador / Alternator: 9 120 080 168, 9 120 080 172

Aplicação / Application: **CHEVROLET-GM:** IPANEMA - 1.8 C/ AR CONDICIONADO, KADETT - 1.8 / 2.0, MONZA - CLASSIC MPFI

5 canais / grooves

Bosch **UF-3339** Original: 9 122 080 693

Alternador / Alternator: 9 120 080 165

Aplicação / Application: **FIAT:** ELBA - 1.6, ÁLCOOL/ GASOLINA, COM AR CONDICIONADO, PRÊMIO, UNO 1.6R / MPI

4 canais / grooves

Bosch **UF-3341** Original: 9 122 080 420

Alternador / Alternator: 9 120 080 170, 9 120 080 171

Aplicação / Application: **CHEVROLET-GM:** IPANEMA 1.8 C/ AR CONDICIONADO, KADETT 1.8 / 2.0, MONZA - CLASSIC MPFI, **FIAT:** TEMPRA 2000 16V 2.0I TURBO - SÉRIE OURO / PRATA

4 canais / grooves

Bosch **UF-3342** Original: 404 001

Alternador / Alternator: **WAPSA**

Aplicação / Application: **CLARK:** EMPILHAD. CFY20 / CFY25 - C/ MOTOR PERKINS 6 CIL., EMPILHAD. CHY100 / CHY120 / CHY140 / CHY70 / CHY80, MINI PÁ CARREG. BOB CAT, **FORD:** AERO WILLYS E ITAMARATY - (1973→), JEEP, PICK-UP, RURAL - 6 CIL - (1973→)

1 canal / groove

Bosch **UF-3343** Original: 9 121 080 286

Alternador / Alternator: 9 120 080 054, 9 120 080 107

Aplicação / Application: **AGRALE:** TRATORES - 4200 / 440 / 4400 - TODOS ATÉ (08/1985), **TOYOTA:** UTILITÁRIO BANDEIRANTE - (MBB-OM314) (→12/1987), **YANMAR:** MICRO TRATOR - NS11, MOTOR BT 83 / 22 (→12/1986)

1 canal / groove

Bosch **UF-3344** Original: 404 066, 9 121 450 487

Alternador / Alternator: **WAPSA**

Aplicação / Application: **CLARK:** PÁ CARREGADEIRA MICHIGAN - 65R / 75A / 75II / 75III, **FORD:** CAMINHÕES - F11000 / F12000 / F13000 / F600 / F750 COM MOTOR-PERKINS 4 E 6 CIL., **HYSTER:** EMPILHADEIRA/ FORKLIFT - 110J / 130J / 150J - TODOS C/ MOTOR PERKINS 4236

1 canal / groove

Bosch

UF-3346

Original: 404 055, 9 121 450 898

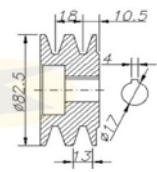
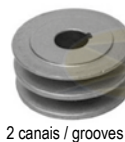

2 canais / grooves

Alternador / Alternator: 9 120 450 005, 9 120 450 006, 9 120 450 124

Aplicação / Application: FORD: CARGO - 1113 / 1114 / 1117 / 1215 / 1218 / 1313 / 1314 / 1317 / 1415 / 1418 / 1419 / 1514 / 1517 / 1615 / 1618 / 1619 / 2215 / 2218 / 2319 / 35300 / 3224 / F6000 / F7000 / FTO-TC / HTA / NA / TC / TCA / TCP, /

NEW HOLLAND: FTO-TCP / T-SÉRIE TF42 / TR86 / 96 / TX30 / TX32 / 34 / 36

Bosch

UF-3347

Original: 404 036, 9 121 450 496

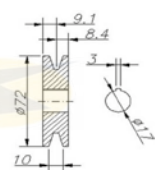

1 canal / groove

Alternador / Alternator: WAPSA: 9 120 450 015, 9 120 450 020

Aplicação / Application: VOLKSWAGEN: CAMINHÕES 12140 - C/ MOTOR MWM, 6 TON. 14V 35A / 6.90 / 7.90 / 7110 / 11140

Bosch

UF-3348

Original: 9 121 456 184

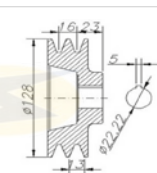
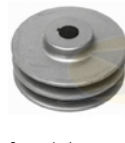

2 canais / grooves

Alternador / Alternator: 9 120 456 040

Aplicação / Application: MERCEDES-BENZ: ÔNIBUS C/ MOTOR SÉRIE BR400

Bosch

UF-3349

Original: 404 054, 9 121 456 137

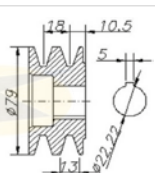
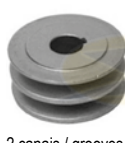

2 canais / grooves

Alternador / Alternator: WAPSA: 9 120 456 005, 9 120 456 025

Aplicação / Application: FORD: CAMINHÕES CARGO - 1113 / 1114 / 1117 / 1215 / 1218 / 1313 / 1314 / 1317 / 1415 / 1418 / 1419 / 1514 / 1517 / 1615 / 1618 / 1619 / 2215 / 2218 / 2218T / 2319 / 3224 TURBO / 3530, TODOS C/ 14V 90A,

CAMINHÕES 1419 / 1619 / 2319 TODOS (→1987) C/ 14V 90A, MÜLLER: TRATOR AGRÍCOLA TM 31 (14V 90A); VOLVO: ÔNIBUS B58 E B10M (28V 75A)

Bosch

UF-3350

Original: 9 122 080 925

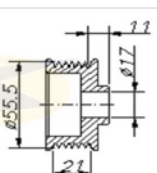

6 canais / grooves

Alternador / Alternator: 9 120 080 215

Aplicação / Application: RENAULT: CLIO - 1.6I - AS, R9 - AM / AS, R11 - AM / AS, R19 1.6I - AM / AS / BR

Bosch

UF-3351

Original: 9 121 456 033

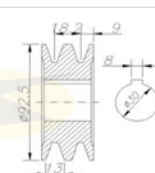
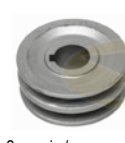

2 canais / grooves

Alternador / Alternator: 9 120 456 003, 9 120 456 014, 9 120 456 016

Aplicação / Application: SCANIA: CHASSIS P/ ÔNIBUS - F112HL / 113HL / K113CL / K113TL / L113CL / S113AL / S113CL

Bosch

UF-3352

Original: 9 122 080 604

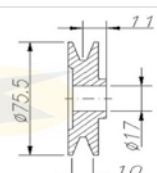
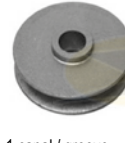

1 canal / groove

Alternador / Alternator: 9 120 080 192, 9 120 080 195

Aplicação / Application: CHEVROLET-GM: D20 - 4.1 LTS. - 14V 21, 23, 55, 75A - (03/1992→)

Bosch

UF-3353

Original: 9 122 080 633

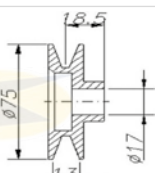
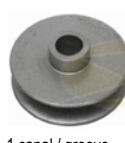

1 canal / groove

Alternador / Alternator: 9 120 080 196, 9 120 080 197

Aplicação / Application: CHEVROLET-GM: D20 / D40 / D6000 / BONANZA / VERANEIO - COM E SEM AR CONDICIONADO, À DIESEL (03/1992→)

Bosch

UF-3355

Original: 9 122 080 030

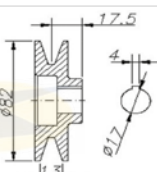
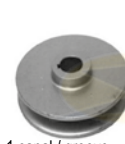

1 canal / groove

Alternador / Alternator: 9 120 080 130, 9 120 080 157, 9 120 080 188

Aplicação / Application: VALMET: TRATORES / TRACTORS - 118 / 138 / 78 / 88 / 128 / 128 4X / 68 / 68 CAFÉ / 880 / 880 4X

Bosch

UF-3356

Original: 9 121 456 162

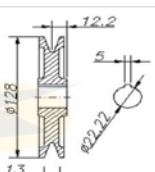
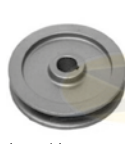

1 canal / groove

Alternador / Alternator: 9 121 456 162

Aplicação / Application: MERCEDES-BENZ: ÔNIBUS - C/ MOTOR M36, O371 RS, PLATAFORMA - O371 RS A, O371 RSD, O371 UP

Bosch

UF-3358

Original: 9 120 080 147, 9 120 080 181

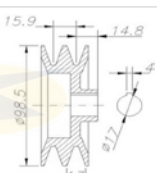
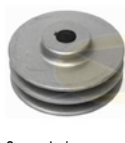

2 canais / grooves

Alternador / Alternator: 9 120 080 147, 9 120 080 181

Aplicação / Application: MERCEDES-BENZ: L1214 / 1218 / 1414 / 1418 / 1614 / LS1625 / 1630 / LS1935 / LS1941

Bosch

UF-3360

Original: 9 122 080 295

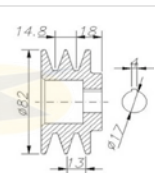
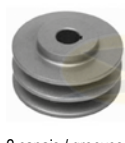

2 canais / grooves

Alternador / Alternator: 9 120 080 157, 9 120 080 188

Aplicação / Application: VALMET: TRATORES - 980 / 1580 / 1780 - COM MOTOR MWM

Bosch **UF-3361** Original: 3 431 557 116

Alternador / Alternator: _____

Aplicação / Application: MERCEDES-BENZ

2 canais / grooves

Bosch **UF-3363** Original: 9 121 456 155

Alternador / Alternator: 9 120 456 026, 9 120 456 030

Aplicação / Application: FORD: ÔNIBUS - VOLKSBUS, RANDOM: CAMINHÃO - FORA DE ESTRADA, VALMET: TRATORES, CAMINHÃO, VOLKSWAGEN: CAMINHÕES - 22.210/23.210 - C/ MOTOR CUMMINS EQ. COMERCIAL E PRIM. RIO, CHASSI P/ ÔNIBUS - VOLKSBUS

8 canais / grooves

Bosch **UF-3365** Original: 0 101 549 124

Alternador / Alternator: _____

Aplicação / Application: MERCEDES-BENZ: CAMINHÕES 1938 S / 1938 LS

9 canais / grooves

Bosch **UF-3368** Original: F 000 LD1 373

Alternador / Alternator: 9 120 080 232, F 000 LD0 117

Aplicação / Application: FORD: F1000, CHEVROLET-GM: S10, D 6150, SILVERADO 6.07 T/DLX - C/ AR CONDICIONADO, SCANIA: CHASSI P/ ÔNIBUS C/ MOTOR / W/ ENGL: NE DN11 / DS11 / DS11.34 / DSC 11.18

6 canais / grooves

Bosch **UF-3369** Original: 9 122 080 929

Alternador / Alternator: _____

Aplicação / Application: FIAT: UNO 1.6, PREMIO 1.6, ELBA 1.6 - TODOS COM DIREÇÃO HIDRÁULICA / ALL WITH HYDRAULIC STEERING

4 canais / grooves

Bosch **UF-3371** Original: F 00M 991 149

Alternador / Alternator: 0 124 215 006, 0 124 215 008

Aplicação / Application: VOLKSWAGEN: GOL 1.000, SANTANA 16V

6 canais / grooves

Bosch **UF-3372** Original: _____

Alternador / Alternator: _____

Aplicação / Application: CHEVROLET-GM: CORSA, KADETT, MONZA

5 canais / grooves

Bosch **UF-3373** Original: _____

Alternador / Alternator: _____

Aplicação / Application: FORD: F250 4.2 MWM 6 CC - 90A - 14V

6 canais / grooves

Bosch **UF-3374** Original: _____

Alternador / Alternator: _____

Aplicação / Application: FORD: F250 3.9 CUMMINS 4 CC - 90A - (1999→)

6 canais / grooves

Bosch **UF-3375** Original: F 00M 991 073

Alternador / Alternator: 0 124 415 012

Aplicação / Application: FIAT: PALIO 16V (TODOS / ALL)

5 canais / grooves

Bosch **UF-3376** Original: _____

Alternador / Alternator: 9 120 080 136

Aplicação / Application: VOLKSWAGEN: CAMINHÕES / TRUCKS 16270 / 14170 / 14210 C/ MOTORES / W/ ENGINES CUMMINS K1 65 A - 14V

8 canais / grooves

Bosch **UF-3377** Original: 404 059, 9 121 450 940

Alternador / Alternator: WAPSA

Aplicação / Application: VOLKSWAGEN: CAMINHÕES 16170 / 16220, FORD: CARGO

8 canais / grooves

Bosch **UF-3379** Original: 1 126 600 975

Alternador / Alternator: 70 e 120A

Aplicação / Application: CHEVROLET-GM: ASTRA, CORSA, VECTRA

6 canais / grooves

Bosch **UF-3380** Original: _____

Alternador / Alternator: _____

Aplicação / Application: CATERPILLAR: PÁ-CARREGA-DEIRA 938

2 canais / grooves

Bosch

UF-3381

Original: _____
Alternador / Alternator: 0 120 468 131, 0 120 468 132

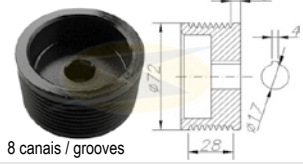

8 canais / grooves

Aplicação / Application: **SCANIA**: T-114/ 114340 / 124360 / 124400 / 124420 / HTN / 144460 / 144530, R-114 / 144460 / 144530 / 164480 / TR-124360 / 124400 / 124420 / 124420-HTI

Bosch

UF-3387

Original: _____
Alternador / Alternator: _____
Aplicação / Application: **KIA**: BESTA GS

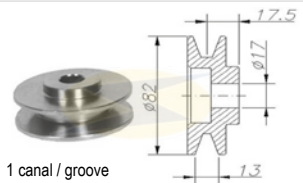

1 canal / groove

Bosch

UF-3390

Original: F 00M 991 060
Alternador / Alternator: 0 124 325 023

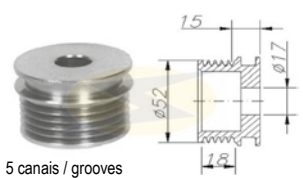

5 canais / grooves

Aplicação / Application: **MERCEDES-BENZ**: CLASSE A

Bosch

UF-3395

Original: _____
Alternador / Alternator: **VOLVO**: 420433
Aplicação / Application: **VOLVO**: EDC

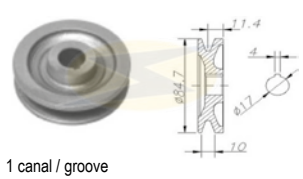

1 canal / groove

Bosch

UF-3401

Original: _____
Alternador / Alternator: _____
Aplicação / Application: **FORD**: F1000 COM ALTERNADOR BOSCH

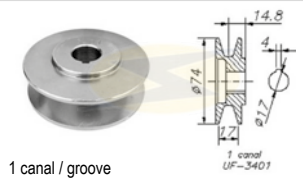

1 canal / groove

Bosch

UF-3406

Original: F 00M 991 338, F 00M 147 893
Alternador / Alternator: 0 124 555 009
Aplicação / Application: **VOLVO**: FH / GLOBO TRATO. B10 M (ELETRÔNICO), B12 B (ELETRÔNICO), FH12, FM, NH12

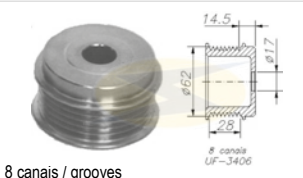

8 canais / grooves

Bosch

UF-3407

Original: _____
Alternador / Alternator: 0 124 325 118
Aplicação / Application: **MERCEDES-BENZ**: CAMINHÕES

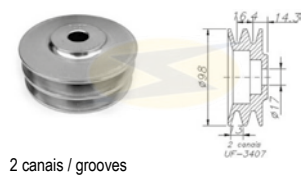

2 canais / grooves

Bosch

UF-3382

Original: 9 122 080 533
Alternador / Alternator: F 000 LD0 106, 9 120 080 184, 9 120 080 187, 9 120 080 202

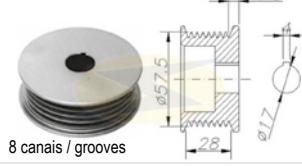

8 canais / grooves

Aplicação / Application: **CASE**: SÉRIE 580H, SH4X2, SH 4X4, TDS 3.9L E MOT. CUMMINS, ALT.K1-14V 23 / 65A. **VOLKSWAGEN**: 7.100(4.0), 8.140 TURBO (4.3), 12.140 (4.3) C/ MOTOR / ENGINE MWM, 12.170, 14.170, 16.170/200

(5.8) C/ MOT. CUMMINS-ALT. K1 14V 3 / 65A

Bosch

UF-3388

Original: _____
Alternador / Alternator: _____
Aplicação / Application: **MERCEDES-BENZ**: COM ALTERNADORES 120 A

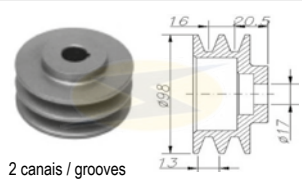

2 canais / grooves

Bosch

UF-3392

Original: 9 123 080 080
Alternador / Alternator: 9 129 080 207
Aplicação / Application: **IVECO**: CAMINHÕES - 120E / 150E / 150T / 160E

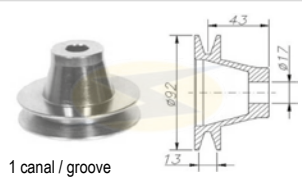

1 canal / groove

Bosch

UF-3396

Original: F 00M LD1 313
Alternador / Alternator: 0 124 315 018, 0 124 315 020, 0 124 315 021, 0 124 315 022, 0 124 325 041, 0 124 325 042, 0 124 325 066, 0 124 325 076

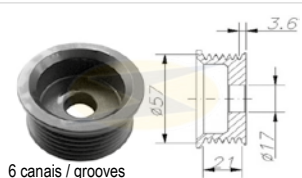

6 canais / grooves

Aplicação / Application: **VOLKSWAGEN**: GOL II 1.0I / 1.6I / 1.6 MI / 1.8 I / 1.8 MI / 2.0 MI / 2.0 MI 16V, LOGUS 1.6I / 1.8 I / 1.8I / 2.0 / MI, PARATI II - 1.6I / 1.6MI / 1.8I / 1.8MI / 2.0I / 2.0 MI / 2.0 MI 16V / PARATI III - 1.6 MI / 1.8 MI / 1.9 D / 2.0 MI, POINTER 1.8 / 1.8I / 2.0 / 2.0 MI, QUANTUM 1.8 / 1.8I / 1.8 MI / 2.0I / 2.0 MI, SANTANA 1.8 / 1.8I / 1.8MI / 2.0I / 2.0MI, SAVEIRO II - 1.6MI / 1.8MI / 2.0MI / SAVEIRO III - 1.6MI / 1.8MI / 1.9D / 2.0MI

Bosch

UF-3402

Original: _____
Alternador / Alternator: _____
Aplicação / Application: **MERCEDES-BENZ**: MODELOS LEVES DE ATÉ 4 TON.

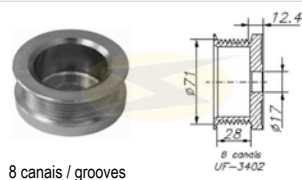

8 canais / grooves

Bosch

UF-3408

Original: 9 122 080 456
Alternador / Alternator: _____
Aplicação / Application: **FIAT**: FIORINO, PRÊMIO, UNO

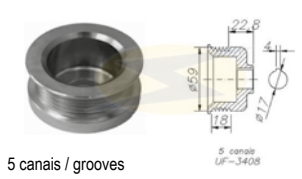

5 canais / grooves

Bosch **UF-3.420** Original: _____

Alternador / Alternator: 0120689562-140A (140A-24V)

Aplicação / Application: **SCANIA**: 124, SCANIA SÉRIE: 114 (K 124 1997→), 93 (F94 - L94 - K94 1998→).

8 canais / grooves

Bosch **UF-3.422** Original: F 00M 991 169

Alternador / Alternator: 1721 - 0124555011, 1620 - 0124325098

Aplicação / Application: **MERCEDES-BENZ**

2 canais / grooves

Bosch **UF-3.424** Original: 409031095

Dinamo / Dynamo: _____

Aplicação / Application: **FIAT**: UNO, CHEVROLET-GM: CHEVETTE, VOLKSWAGEN: SEDAN, BRÁSILIA E KOMBI (PARA VEÍCULOS QUE TRAFEGAM EM ÁREAS URBANAS, QUE NECESSITAM DE RECARGA MAIS RÁPIDA PARA A BATERIA) UTILIZAR CORREIA 10X888

1 canal / groove

Bosch **UF-3.425** Original: F 00M 991 177, F 00M 991 233

Alternador / Alternator: 0124555016, 0124555007

Aplicação / Application: **MERCEDES-BENZ, FORD**: CARGO (CUMMINS), VOLKSWAGEN: COM CUMMINS

8 canais / grooves

Bosch **UF-3.426** Original: _____

Alternador / Alternator: 9 120 456 003 140A

Aplicação / Application: **SCANIA**: F 112 HL, K 113, K 113 CL, K 113 CL / TL, K 113 HL, K 113 TL, K 113 AL, K 113 AL / CL, S 113CL, S 113. **MERCEDES-BENZ**: O 400 RS, O 400 RSD, O 400 RSL, OHL 1628L, OHL 1635, EQUIPAMENTOS DE REFRIGERAÇÃO

2 canais / grooves

Bosch **UF-3.427** Original: _____

Alternador / Alternator: 0 124 325 064

Aplicação / Application: **FORD**: F-250, F-350, F-4000

8 canais / grooves

Bosch **UF-3.428** Original: F00M 991321

Alternador / Alternator: 0 124 515 100

Aplicação / Application: **FIAT**: DUCATO, DAILY

6 canais / grooves

Bosch **UF-3.430** Original: F000D1 429

Alternador / Alternator: F 00LD0 T1 28v 140AMP

Aplicação / Application: **MERCEDES-BENZ**

9 canais / grooves

Bosch **UF-3.435** Original: _____

Alternador / Alternator: 0 120 689 571 , 9 120 456 053 , F 000 LD0 212

Aplicação / Application: **MERCEDES-BENZ**: SÉRIES 14t, 18t, 20t, 25t, 26t, 33t, 41t, O, OH, CLIMABUSS: SISTEMAS DE AR-CONDICIONADO/ AIR-CONDITIONING SYSTEM (ALTERNADORES T1 / ALTERNATORS T1 140 AMP)

2 canais / grooves

Bosch **UF-3.436** Original: F 000 BL1 031, F 000 BL1 301

Alternador / Alternator: F 000 BLO 418

Aplicação / Application: **VW**: GOL, SAVEIRO, VOYAGE, PARATI, PASSAT , POLO, FOX, SPACE FOX, SURAN (TODOS G5 1.6 ALTERNADOR 90A)

6 canais / grooves

Bosch **UF-3.437** Original: F000BL1515

Alternador / Alternator: F000BL0408, (Renault 23100-7633R)

Aplicação / Application: **RENAULT**: LOGAN, CLIO, DUSTER, KANGOO 1.6 16V (2010→)

6 canais / grooves

Bosch **UF-3.438** Original: _____

Alternador / Alternator: 0 124 325 110

Aplicação / Application: **NEW HOLLAND**: TC 55 / 57, UTILITY / S7630 / S8030

1 canal / groove

Delco **UF-3.311** Original: 7331171

Alternador / Alternator: _____

Aplicação / Application: **CHEVROLET-GM**: PICK-UP D10 - (1979→)

1 canal / groove

Delco **UF-3.312** Original: 7320683

Alternador / Alternator: _____

Aplicação / Application: **CHEVROLET-GM**: PICK-UP C10 - 6 CIL. - 67 A 81, CAMINHÕES - A14C / C14C

1 canal / groove

Delco **UF-3313** Original: 7322421

Alternador / Alternator: _____

Aplicação / Application: **CHEVROLET-GM:** OPALA
(1969→1974), PICK-UP - A10 / C10 - 4 CIL. (1976→)

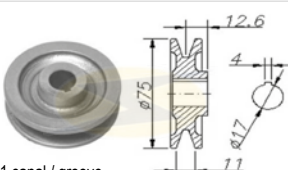

1 canal / groove

Delco **UF-3314** Original: 7332366

Alternador / Alternator: _____

Aplicação / Application: **CHEVROLET-GM:** CHEVETTE
(1973→) OPALA (1975→)

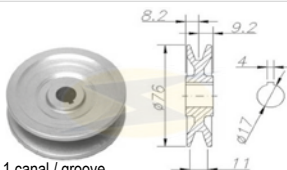

1 canal / groove

Delco **UF-3316** Original: 94632531

Alternador / Alternator: _____

Aplicação / Application: **CHEVROLET-GM:** MONZA

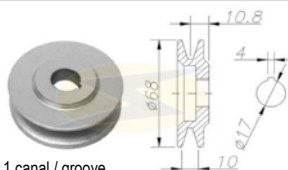

1 canal / groove

Delco **UF-3317** Original: 94648532

Alternador / Alternator: _____

Aplicação / Application: **CHEVROLET-GM:** A10 / C10 / D20 / D40 - TODOS C/ DIREÇÃO HIDRÁULICA

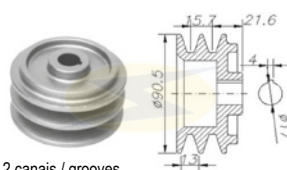

2 canais / grooves

Delco **UF-3340** Original: 93205378

Alternador / Alternator: _____

Aplicação / Application: **CHEVROLET-GM:** KADETT
(1991→) C/ DIREÇÃO HIDRÁULICA, MONZA

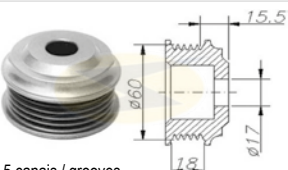

5 canais / grooves

Ford / Motorcraft **UF-3393** Original: F5TU-AA

Alternador / Alternator: **AC** F6HU-AA, 98111216

Aplicação / Application: **FORD:** F250 C/ ALTERNADOR / W/ ALTERNATOR MOTORCRAFT

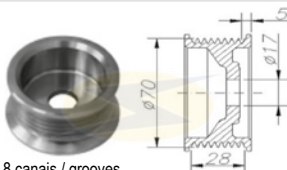

8 canais / grooves

Ford / Motorcraft **UF-3399** Original: F07U A2A

Alternador / Alternator: **F6TU97081905** (14V, 105A)

Aplicação / Application: **FORD:** RANGER 4.0 V6 GAS

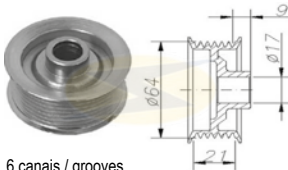

6 canais / grooves

Magneti Marelli **UF-3421** Original: _____

Alternador / Alternator: 540226610, 540226611

Aplicação / Application: **LAND ROVER**

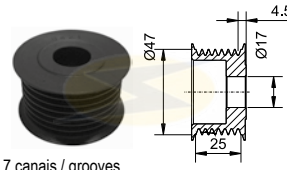

7 canais / grooves

Mitsubishi **UF-3397** Original: _____

Alternador / Alternator: **A005TA2591, A002T82091**

Aplicação / Application: **FORD:** COURIER C/ MOTOR / W/ ENGINE ZETEC, ALTERNADOR / ALTERNATOR MITSUBISHI - 14V 70A E ALTERNADOR HITACHI - 14V 70A, ECOSPORT

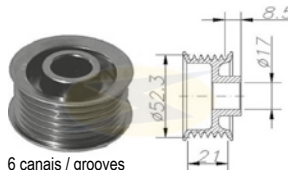

6 canais / grooves

Mitsubishi **UF-3398** Original: XS6U A2A

Alternador / Alternator: **XS6110300AA**

Aplicação / Application: **FORD:** COURIER, FIESTA - C/ MOTOR / W/ ENGINE ROCAM 16V, ALTERNADOR / ALTERNATOR 14V 75A

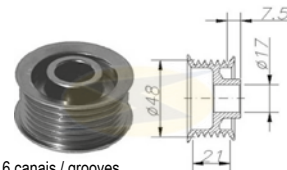

6 canais / grooves

Mitsubishi **UF-3404** Original: _____

Alternador / Alternator: _____

Aplicação / Application: **MITSUBISHI:** EMPILHADEIRA/ FORKLIFT COM ALTERNADOR MITSUBISHI

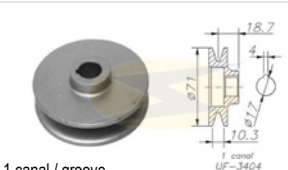

1 canal / groove

Mitsubishi **UF-3419** Original: _____

Alternador / Alternator: _____

Aplicação / Application: **CATERPILLAR:** 320

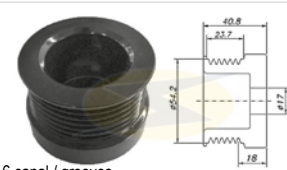

6 canal / grooves

Mitsubishi **UF-3423** Original: _____

Alternador / Alternator: **23100 - 50K 10 A 7 T 03371**
A - 12V

Aplicação / Application: **NISSAN:** EMPILHADEIRAS/ FORKLIFT



1 canal / groove

Mitsubishi **UF-3434** Original: _____

Alternador / Alternator: **A4TU3586, A4T66785, A4TU3521, A4TU7686**

Aplicação / Application: **CATERPILLAR:** 320, 50A, 24V, ESCAFADEIRA 320 E 320L, 50A 24V

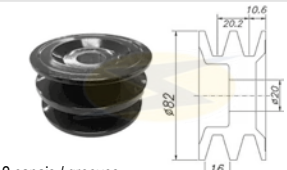

2 canais / grooves

Nippondenso **UF-3366** Original: _____
Alternador / Alternator: ER / IF - IR - IF (90A)
Aplicação / Application: CHEVROLET-GM CHRYSLER, DODGE, EAGLE, JEEP, LEXUS, PLYMOUTH, TOYOTA

6 canais / grooves

Nippondenso **UF-3410** Original: 10.12.11/2671
Alternador / Alternator: _____
Aplicação / Application: TOYOTA: BANDEIRANTES, JIPE, PICAPE C/ MOTOR TOYOTA 14B 3.7L (DIESEL)

1 canal / groove

Prestolite (Delphi/Indiel/Lucas) **UF-3333** Original: 2Y4213
Alternador / Alternator: _____
Aplicação / Application: CATERPILLAR: CATERPILLAR - FURO PEQUENO

2 canais / grooves

Prestolite (Delphi/Indiel/Lucas) **UF-3334** Original: 2Y8924
Alternador / Alternator: _____
Aplicação / Application: CATERPILLAR: CATERPILLAR - FURO GRANDE

2 canais / grooves

Prestolite (Delphi/Indiel/Lucas) **UF-3359** Original: 2Y 4206
Alternador / Alternator: _____
Aplicação / Application: CATERPILLAR

2 canais / grooves

Prestolite (Delphi/Indiel/Lucas) **UF-3362** Original: 2P6265, 4N8090
Alternador / Alternator: _____
Aplicação / Application: CATERPILLAR: COM ALTERNADOR PRESTOLITE / WITH PRESTOLITE ALTERNATOR

2 canais / grooves

Valeo **UF-3378** Original: _____
Alternador / Alternator: 439427
Aplicação / Application: CHEVROLET-GM: ASTRA, CORSA, VECTRA - TODOS C/ ALT. VALEO 100A

6 canais / grooves

Valeo **UF-3391** Original: 2542347-A
Alternador / Alternator: _____
Aplicação / Application: MERCEDES-BENZ: CLASSE A-C / ALTERNADOR VALEO

5 canais / grooves

Valeo **UF-3405** Original: _____
Alternador / Alternator: A14N183M
Aplicação / Application: VOLVO: FH, NH / GLOBO TRATOR, COM ALTERNADOR VALEO

8 canais / grooves

Valeo / Bosch **UF-3409** Original: Valeo: SGSSG9B 047 254-2548A, Bosch: 012425031
Alternador / Alternator: 8200 727051B, 8200 103726-90A, 0 124 325 024, 0 124 325 031, 0 124 415 013, 0 124 415 014, 0 124 415 038, 0 124 415 040, 0 124 415 041, 0 986 042 720, 0 986 042 770
Aplicação / Application: RENAULT: LOGAN, ESPACE, KANGOO, LAGUNA, MEGANE, SANDERO, SCENIC, CITROEN

6 canais / grooves

Valeo **UF-3411** Original: 593518
Alternador / Alternator: _____
Aplicação / Application: RENAULT

6 canais / grooves

Valeo **UF-3412** Original: 592920
Alternador / Alternator: _____
Aplicação / Application: VOLKSWAGEN, AUDI

6 canais / grooves

Valeo

UF - 3.413

Original: 493813

Alternador / Alternator: 43 9466

Aplicação / Application: FORD: COURIER 1.0 / 1.6, ESCORT 1.6 / 1.6 SW, FIESTA 1.0 / 1.6 / SEDAN, KA 1.0 / 1.6, NOVO FIESTA 1.0 / 1.6

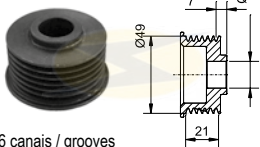

6 canais / grooves

Valeo

UF - 3.414

Original: 493802

Alternador / Alternator:

Aplicação / Application: CHEVROLET - GM

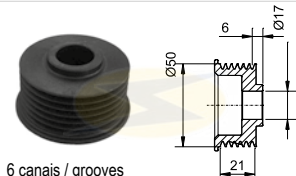

6 canais / grooves

Valeo

UF - 3.415

Original: 493807

Alternador / Alternator:

Aplicação / Application: FORD

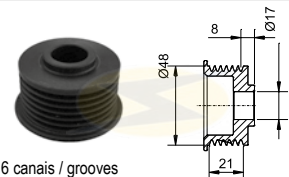

6 canais / grooves

Valeo

UF - 3.416

Original: 493804

Alternador / Alternator:

Aplicação / Application: CITROEN, PEUGEOT

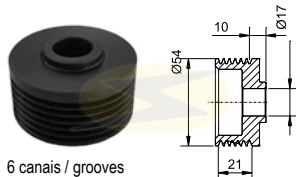

6 canais / grooves

Valeo

UF - 3.417

Original: 493800

Alternador / Alternator:

Aplicação / Application: CHEVROLET - GM

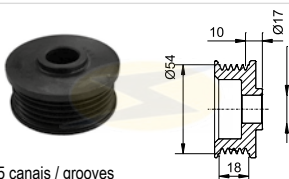

5 canais / grooves

Valeo

UF - 3.418

Original: 593623

Alternador / Alternator:

Aplicação / Application: PEUGEOT

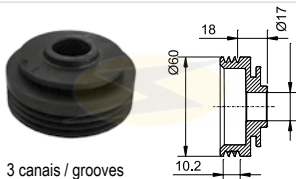

3 canais / grooves

Valeo

UF - 3.429

Original:

Alternador / Alternator: A13V1179

Aplicação / Application: RENAULT: MASTER COM MOTOR IVECO

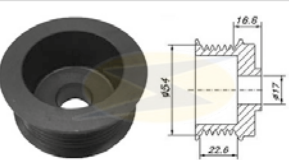

6 canais / grooves

Valeo

UF - 3.432

Original:

Alternador / Alternator:

Aplicação / Application: VOLVO

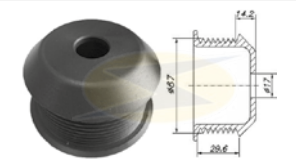

8 canais / grooves

Diversos

UF - 3.335

Original: 625/0333653

Alternador / Alternator:

Aplicação / Application: SCANIA: MOTORES / ENGINES (04/1987 →)

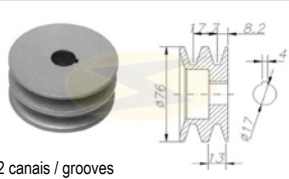

2 canais / grooves

Diversos

UF - 3.345

Original: 7 079 314

Alternador / Alternator:

Aplicação / Application: FIAT: PALIO

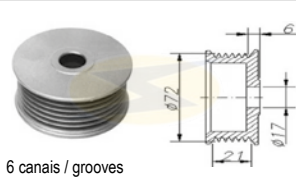

6 canais / grooves

Diversos

UF - 3.354

Original:

Alternador / Alternator:

Aplicação / Application: MAZDA, MERCURI, MITSUBISHI

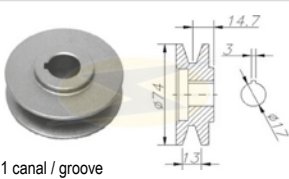

1 canal / groove

Diversos

UF - 3.357

Original: 113903109-2

Alternador / Alternator:

Aplicação / Application: VOLKSWAGEN: SEDAN - TODOS C/ DÍNAMO 6V

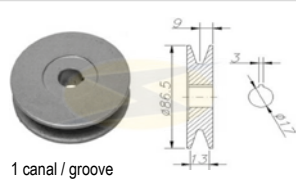

1 canal / groove

Diversos

2 canais / grooves

UF-3364 Original: _____
 Alternador / Alternator: _____
 Aplicação / Application: VALMET: SÉRIE 1795

Diversos

6 canais / grooves

UF-3367 Original: _____
 Alternador / Alternator: _____
 Aplicação / Application: PEUGEOT: 405 - 1.6 / 1.8 / 1.9, 406 - 1.6 / 1.8, CITROEN: XSARA - 1.8, ZX - 1.6 / 1.8 / 1.9 / 2.0

Diversos

6 canais / grooves

UF-3370 Original: _____
 Alternador / Alternator: _____
 Aplicação / Application: RENAULT, CITROEN, PEUGEOT

Diversos

1 canal / groove

UF-3383 Original: 82610900
 Alternador / Alternator: _____
 Aplicação / Application: VALMET: TRATORES - 1780 / 1280 - C/ MOTOR / W/ ENGINE MWM (PAINEL DIGITAL / DIGITAL PANEL)

Diversos

2 canais / grooves

UF-3384 Original: 82610900
 Alternador / Alternator: _____
 Aplicação / Application: VALMET: TRATORES - 1780 / 1280 - C/ MOTOR / W/ ENGINE MWM (PAINEL DIGITAL / DIGITAL PANEL)

Diversos

2 canais / grooves

UF-3385 Original: 82024500
 Alternador / Alternator: _____
 Aplicação / Application: VALMET: TRATORES / TRACTORS - BH180 / BH140

Diversos

1 canal / groove

UF-3386 Original: 82024400
 Alternador / Alternator: _____
 Aplicação / Application: VALMET: TRATORES / TRACTORS - BM110 / BM985

Diversos

2 canais / grooves

UF-3389 Original: _____
 Alternador / Alternator: _____
 Aplicação / Application: OUTRAS: CONDICIONADOR DE AR PARA ÔNIBUS / AIR CONDITIONING SYSTEM FOR BUS

Diversos

2 canais / grooves

UF-3394 Original: _____
 Alternador / Alternator: _____
 Aplicação / Application: SCANIA: COM AR CONDICIONADO - ALTERNADOR 105A

Diversos

2 canais / grooves

UF-3400 Original: _____
 Alternador / Alternator: _____
 Aplicação / Application: CHEVROLET-GM: VECTRA C/ AR-CONDICIONADO 120A, MARCOPOLO: MICRO ÔNIBUS VOLARE

Diversos

1 canal / groove

UF-3403 Original: _____
 Alternador / Alternator: _____
 Aplicação / Application: CHEVROLET-GM: PICK-UP C 10 - 6 CIL. (1967→1981), CAMINHÕES A14C / C14C

Diversos / ZM Motores

2 canais / grooves

UF-3431 Original: _____
 Alternador / Alternator: ZM 9010501
 Aplicação / Application: GREEN HORSE: TRATORES AGRÍCOLAS

Diversos

10 canais / grooves

UF-3433 Original: _____
 Alternador / Alternator: _____
 Aplicação / Application: VOLVO: EMPILHADEIRA LINDE / FORKLIFT

Wapsa

1 canal / groove

UF-5505 Original: _____
 Dinamo / Dynamo: (WAPSA)
 Partida / Starter: _____
 Aplicação / Application: VOLKSWAGEN: SEDAN, BRÁSILIA E KOMBI. POLIAS: 3.301, 3.302 E 3.424
 Observação / Notes: 100 peças por pacote / 100 pieces per package.

Bosch

UF-4.401

Tipo / Type: **MPB e MPJ**



Original: 214013

Partida / Starter: 9 000 083 043, 9 000 083 065, 9 000 083 066, 9 000 083 068, 9 000 453 016, 9 000 453 020, 9 000 453 033, 9 000 453 034, 9 000 453 038, 9 000 453 041, 9 000 453 044, 9 000 453 045, 9 000 453 046, 9 000 453 047, 9 000 453 048, 9 000 453 049, 9 000 453 050, 9 000 453

051, 9 000 453 052, 9 000 453 053, 9 000 453 054, 9 000 453 060, 9 000 453 061

Aplicação / Application: **AGRALE-DEUTZ, CASE, CBT, CHEVROLET-GM, CHRYSLER, CLARK, EATON, FIAT-ALLIS, FORD, HYSTER, MASSEY-FERGUSON, NEW HOLLAND, VOLKSWAGEN**

APLICAÇÃO / APPLICATION: **UF-1.102 / 1.103 / 1.110 / 1.111**

Bosch

UF-4.403

Tipo / Type: **EF**



Original: 9 001 082 207

Partida / Starter: 0 001 211 219, 9 000 082 028, 9 000 082 033, 9 000 082 042, 9 000 082 046, 9 000 082 049, 9 000 082 053, 9 000 082 054, 9 000 082 059, 9 000 082 061, 9 000 082 064, 9 000 082 066, 9 000 082 069, 9 000 082 070, 9 000 082 073, 9 000 082 074, 9 000 082 078, 9 000 082

079, 9 000 082 082, 9 000 082 083, F 000 ALO 301, F 000 ALO 306

Aplicação / Application: **AGRALE-DEUTZ, CHEVROLET-GM, FIAT, FORD, GURGEL, LADA, MOTOR TIETÊ,**

VOLKSWAGEN, YANMAR

APLICAÇÃO / APPLICATION: **UF-1.101**

Bosch

UF-4.406

Tipo / Type: **MWB**



Original: 214006 (WAPSA)

Partida / Starter: 9 000 451 017

Aplicação / Application: **VOLKSWAGEN, FORD:**
ESCORT - ÁLCOOL E TRANSMISSÃO AUTOMÁTICA /
AUTOMATIC TRANSMISSION

APLICAÇÃO / APPLICATION: **UF-1.107**

Bosch

UF-4.408

Tipo / Type: **ED**



Original: 9 001 082 261

Partida / Starter:

Aplicação / Application: **FORD: CORCEL, VOLKSWAGEN**

Bosch

UF-4.415

Tipo / Type: **DM, DW**



Original: 1 001 933 000, 1 001 933 101, 1 001 933 059

Partida / Starter:

Aplicação / Application: **FIAT, CHEVROLET-GM, NISSAN, TROLLER**

Bosch

UF-4.402

Tipo / Type: **JF**



Original: 2 001 933 134, 2 001 933 135

Partida / Starter: 0 001 362 046, 0 001 362 081, 0 001 367 029, 0 001 367 054, 0 001 367 061, 0 001 368 001, 0 001 368 069, 0 001 368 300, 0 001 368 301, 0 001 368 302, 0 001 368 306, 0 001 368 307, 0 001 368 309, 0 001 369 014, 9 000 083 028, 9 000 083 029, 9 000 083 031, 9 000 083 035, 9 000 083

036, 9 000 083 038, 9 000 083 042, 9 000 083 043, 9 000 083 050, 9 000 083 053, 9 000 083 054, 9 000 083 055, 9 000 083 056, 9 000 083 058, 9 000 083 059, 9 000 083 061, 9 000 083 062, 9 000 083 063, 9 000 083 064, 9 000 083 065, 9 000 083 066, 9 000 083 067, 9 000 083 068, 9 000 083 069, 9 000 083 071, 9 000 083 072, 9 000 083 073, 9 000 083 074, 9 000 083 075, 9 000 083 076, 9 000 083 077, 9 000 453 072, 9 000 453 074, 9 000 453 075, 9 000 453 076, 9 000 453 077, 9 000 453 079, 9 000 453 080, 9 000 453 082, 9 000 453 083, 9 000 453 086, 9 000 453 088, 9 000 453 089, 9 000 453 090, 9 000 453 091, F 000 ALO 602, F 000 ALO 700

Aplicação / Application: **AGRALE-DEUTZ, CASE, CBT, CHEVROLET-GM, EL DETALLE, FIAT, FIAT-ALLIS, FORD, IVECO, JOHN DEERE, KOMATSU, MASSEY-FERGUSON, MAXION, MERCEDES-BENZ, MÜLLER, MWM-DIESEL, NEW HOLLAND, PERKINS, PUMA, SLC, TOYOTA, VALMET, VOLKSWAGEN, VOLVO, YANMAR**

APLICAÇÃO / APPLICATION: **UF-1.104 / 1.105 / 1.112 / 1.113**

Bosch

UF-4.404

Tipo / Type: **JD**



Original: 9 001 083 243

Partida / Starter: 9 000 083 024, 9 000 083 053, 9 000 083 069, 9 000 083 072

Aplicação / Application: **FIAT: 70 / 100 / 130, AGRALE-DEUTZ: 1800 D, BX 4.60 / 60, TX 1600, CASE: W18 / W20 / W20 B, CBT: 1065 / 1105 / 2080 / 2105 / 8060 4X4,**

MERCEDES-BENZ: SÉRIES - 6T L / 10T / 11T L / 13T L / 15T L / 20T L / 22T L / O, SLC: 6200 / 6200 TURBO / 7200 / 7700 / TURBO, MÜLLER: VIBRO RT 62 / 82, MWM-DIESEL: D 229-3 / 229-4 / 229-6, TBD 229-EC-6, TD 229-6, SLC: 7000 / 7200 TURBO, VALMET: 62 ID, 65 ID, 85 ID, 110 ID, 685, 685 ECO, MASSEY FERGUSON: MF-200-235 / 265 / 265 / 4

Bosch

UF-4.407

Tipo / Type: **MWB**



Original: 214011 (WAPSA)

Partida / Starter:

Aplicação / Application: **VOLKSWAGEN, FORD**

APLICAÇÃO / APPLICATION: **UF-1.107**

Bosch

UF-4.411

Tipo / Type: **DA, DW, DM**



Original: 1 001 933 111

Partida / Starter: F 000 ALO 401

Aplicação / Application: **VOLKSWAGEN: GOL, PARATI GERAÇÃO 2 E 3 COM MOTORES 1.0 MI, 16V E TURBO A PARTIR DE SETEMBRO/2001, PARTIDAS DW E DM, GM, FIAT: DUCATO, FORD**

Bosch **UF - 4.416** Tipo / Type: **EV**

Original: 9 003 333 931

Partida / Starter: 0 001 223 505, 0 001 223 003, 0 001 223 010, 0 001 231 003, F 002 G20 904, BC45-11001-BA

Aplicação / Application: **FORD:** CARGO 816 / 1119 / 1319 / 1519 / 1719 / 1729 / 1723 / 2423 / 2429 / 2623 / 2629 / 1317 / 1517 / 1717 / 1722 / 2422 / 2626 / 2628 / 2622 / 2626,

MOTOR CUMMINS ELETRÔNICO 24V MOTOR ISC 4.5L E 6.7L (→2010), FIAT: DUCATO, IVECO , MBB

Bosch / Delco **UF - 4.428** Tipo / Type: **JE**

Original: 2 001 933 018/021, DELCO 1907195, 19070195

Partida / Starter: 0 001 371 004, 0 001 371 005, 0 001 371 006, 0 001 371 007, 0 001 371 008, 0 001 371 010, 0 001 371 012, 0 001 371 013, 0 001 372 001, 0 001 372 002, 0 001 372 003, 0 001 372 004, 0 001 372 005, 0 001 372 006

Aplicação / Application: **CASE:** W 36 B TURBO, **CUMMINS:**

CT 6 CT 8.3, **KENWORTH:** 13.120 / 22.210 / 23.210, **VOLKSWAGEN:** 16T 16.210, **MBB:** 16L 16.25, 18TL LG 18.25, 19TL LS 19.38, 23TLL / LB / LK 23.25, 26TLLS 26.38. **SCANIA:** SÉRIES 114 / 124 / DS / DSC / DSI

Delco **UF - 4.405**

Original: 11932205

Partida / Starter:

Aplicação / Application: **CHEVROLET-GM:** OPALA, CARAVAN

Delco **UF - 4.410** Tipo / Type: **28MT**

Original: 10457361

Partida / Starter: 10479626

Aplicação / Application: **MERCEDES-BENZ:** CAMINHÕES E ÔNIBUS 712 / 912 / 914 / 1215 / 1417 / 1625 / 1628 / 1632 / 1721 / 1725 / 2423

Delco **UF - 4.431** Tipo / Type: **29MT**

Original: 10515804, 10515805

Partida / Starter: 8200003, 8200004, 8200054, 8200064, 8200138, 8200196, 8200231, 8200292, 8200295, 8200296, 8200297, 8200326, 8200331, 8200357, 8200386, 8200474, 8200478, 8200495, 8200511, 8200512

Aplicação / Application: **CNH, FORD, MERCEDES-BENZ, VOLVO, VOLKSWAGEN**

Iskra **UF - 4.433** Tipo / Type: **AZF4595, Z10, 4.2 Kw**

Original: 16.908.457, 16.908.335

Partida / Starter: 11.131.370, 11.131.659

Aplicação / Application: **NEW HOLLAND:** COMBINE CS 660 - CUMMINS L6 8.3 280CV (COLHEITADEIRA / COMBINE)

Bosch **UF - 4.427** Tipo / Type: **JE**

Original: 2 001 933-021, N° Antigo - 9 001 453 645

Partida / Starter:

Aplicação / Application: **MERCEDES-BENZ, CARGO, CAMINHÃO VOLKSWAGEN**

Bosch **UF - 4.434** Tipo / Type: **K1, CDS**

Original: F 000 CD1 020

Partida / Starter: 000 CD0 800, F 000 CD0 900, F 000 CD0 A90, 51888975, 0 001 121 439, 0 001 121 440, 51865316, F 000 CD0 001, F 000 CD0 002, F 000 CD0 003, F 000 CD0 9A0, F 000 CD1 020

Aplicação / Application: **CHEVROLET: MONTANA, DACIA:**

DUSTER, LOGAN, LOGAN MCV, SANDERO, FIAT: FIORINO 1.3 FIRE, DOBLO, PALIO, STRADA 1.4 / 1.6, IDEA, UNO (NOVO), MAREA, STRADA 1.4 / 1.6, PUNTO, BRAVO. TODOS MOTORES / All Engines: E.TORQ, **VOLKSWAGEN:** GOL, VOYAGE 1.0 / 1.6, POLO, SAVEIRO, FOX, SPACEFOX 1.0 / 1.6, GOLF 2.0, **RENAULT:** DUSTER, LOGAN 1.6 / MCV, SCENIC 1.6, MEGANE 1.6, SANDERO, TODOS / ALL 1.0 (2006 →)

Delco **UF - 4.409** Tipo / Type: **28MT**

Original: 10456464

Partida / Starter: 113277, 10479621

Aplicação / Application: **CUMMINS:** MOTORES 3,96 KW 24V, MOTORES 2,90 KW 12V

Delco **UF - 4.422**

Original: PG 260

Partida / Starter: 900890, 9000891, 2415.198 ED.T

Aplicação / Application: **CHEVROLET-GM:** ASTRA, BLAZER / S10 VORTEC V6 4.3L, VECTRA, CORSA, FORD: ECOSPORT

Delco **UF - 4.432** Tipo / Type: **38MT**

Original: 10512089

Partida / Starter: 8200005, 8200025, 8200053, 8200072, 8200077, 200078, 200356

Aplicação / Application: **CUMMINS, FORD, VOLKSWAGEN**

Magneti Marelli **UF - 4.417**

Original:

Partida / Starter: MAGNETI MARELLI

Aplicação / Application: **FIAT**

Magneti Marelli **UF-4.424**



Original: _____
Partida / Starter: MT67, MT68, MT71, MT72
Aplicação / Application: **AGRIFULL, CARRARO, FIAT ALLIS, FIAT IVECO, RUGGERINI, SIMIT, SLANZ**

Mitsubishi **UF-4.420**

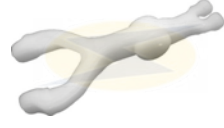

Original: _____
Partida / Starter: CGP 25, MOT80081, MOT80381, MOT80881, MOT80981, MOT81081
Aplicação / Application: **CHEVROLET-GM, CLARK, YALE**

Mitsubishi **UF-4.421**



Original: MD611223, M864X09771
Partida / Starter: M000T32071ZC, M000T32071, MOT32071, MOT32071ZC, (CHRYSLER 05034555AA, 5034555AA), PM6R M1T 60081
Aplicação / Application: **CHRYSLER:** SEBRING 2.4L(144) L4 (2007→2009), **DODGE:** AVENGER 2.4L(144) L4 (2008→2009), CALIBER 1.8L(110) / 2.0L(122) / 2.4L(144) L4 (2007→2009), JOURNEY 2.4L(144) L4 (2009), **ISUZU:** C-240 DIESEL ENGINES, **MAZDA:** EMPILHADEIRA / FORKLIFT, **MITSUBISHI:** EMPILHADEIRA / FORKLIFT, PAJERO, **PEUGEOT:** 405, **JEEP:** COMPASS 2.0L(122) / 2.4L(144) L4 (2007→2009), PATRIOT 2.0L(122) / 2.4L(144) L4 (2007→2009), PATRIOT L4 (2007→2009), **MERCURY, SUBARU, SUZUKI, YALE:** EMPILHADEIRA / FORKLIFT

Mitsubishi **UF-4.435** Tipo / Type: -

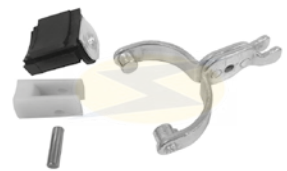

Original: _____
Partida / Starter: M9T62572ZA, M9T62671, M9T661171, M9T61671
Aplicação / Application: **IVECO:** EUROSTAR 190 / 260 / 440, EUROTECH 190/260/440, EUROTRAKKER 190/260 / 340 / 380 / 400 / 410 / 440 / 720, STRALIS 190 / 260 / 400 / 440, STRALIS L 190 / 260 / 440, TRAKKER 190 / 260 / 340 / 380 / 400 / 410 / 440 / 720, TRAKKER N 190 / 260 / 340 / 380 / 400 / 410 / 440 / 720, **FORD:** L6000 / 7000 / 8000 / 9000 C/ MOTOR CUMMINS ISM DE 1985 A 1999, **FREIGHTLINER:** C/ MOTOR CATERPILLAR DE 1999 A 2007, **VOLVO:** VHD SERIES DE 1998 A 2003 CUMMINS ISM, VNM SERIES DE 1997 A 2003 CUMMINS ISM, WA / WC / WG / WH / WI / WX SERIES DE 1997 A 2001 CUMMINS ISM, 9700 / 9900, B 12 B / FH 12 340 / 12 380 / 12 420 / 12 460 / 12 500, FH 380 / 400 / 420 / 440 / 460 / 480 / 500 / 520 / 540, FM 12 340 / 12 420, FM 360 / 380 / 400 / 420 / 440 / 460 / 480 / 500 , **VW:** 13-180 / 15-180 / 17-210 / 17-240 / 17-260 / 26-260 / 31-260 / 24-280, CONSTELLATION

Mitsubishi **UF-4.436** Tipo / Type: _____



Original: _____
Partida / Starter: M9T82171, M9T80472
Aplicação / Application: **MB:** AXOR 2035 / 2040 / 2044 / 2540 / 2544 / 2640 / 2644 / 3340 / 3344, ACTROS 1832 / 1846 / 1850 / 1854 / 1858 / 2032 / 2046 / 2050 / 2054 / 2532 / 2546 / 2550 / 2554 / 2558 / 2632 / 2646 / 2650 / 2654 / 2658 / 3232 / 3246 / 3332 / 3346 / 3350 / 3354 / 3358 / 4146 / 4150, ACTROS BLUETEC 1832 / 1836 / 1841 / 1844 / 1846 / 1848 / 1851 / 1855 / 1860 / 2032 / 2036 / 2041 / 2044 / 2046 / 2048 / 2051 / 2055 / 2532 / 2536 / 2541 / 2544 / 2546 / 2548 / 2551 / 2555 / 2560 / 2632 / 2636 / 2641 / 2644 / 2646 / 2648 / 2651 / 2655 / 3232 / 3236 / 3241 / 3244 / 3246 / 3248 / 3332 / 3336 / 3341 / 3344 / 3346 / 3348 / 3351 / 3355 / 3360 / 4141 / 4144 / 4146 / 4148 / 4151, ACTROS 1861 BLACK EDITION, LS 1634, O 345 G, O 500 MA, O 500 RS-RSD, O 530 GN3 (CITARO), O 530 CN3 UESTRA (CITARO), O 530 GNUE3 (CITARO), O 530 N3 (CITARO), O 530 N3 LANG (CITARO), O 580 RHD-17 (TRAVEGO), TOURISMO 15 RHD/SHD

Mitsubishi **UF-4.437** Tipo / Type: -



Original: _____
Partida / Starter: M2T87671
Aplicação / Application: **RENAULT:** MASTER CHASSI 2.8TD, MASTER VAN 2.8TD, MASTER CHASSI 2.5TD, MASTER VAN 2.5TD

Motorcraft **UF-4.425** Tipo / Type: **PMGR**



Original: SZ-847 (Ford E90Z-11067-A)
Partida / Starter: Ford PMGR E90F11000AA, E90F-11000BA, E9SF11000AA, E9SF11000BA, F02F11000AA, F07U11000AAA, F07U11000ABA, F0CF11000AA, F17U11000AB, F1VU11000AA
Aplicação / Application: **FORD:** ECOSPORT, KA, FIES-TA, COURIER, ESCORT, BRONCO

Motorcraft **UF-4.429** Tipo / Type: **PMGR**



Original: _____
Partida / Starter: FORD PMGR (Mancal de acionamento curto / Noseless Starter)
Aplicação / Application: **VOLKSWAGEM:** GOL, PARATI, SAVEIRO

Prestolite **UF-4.413** Tipo / Type: **M93/100, Com Mola**



Original: K01401 (Delphi / Lucas / Indiel)
Partida / Starter: M93-12V, M100 12/24V
Aplicação / Application: **AGRALE, FORD, CHEVROLET-GM, CUMMINS, VOLKSWAGEM, MERCEDES-BENZ, PEUGEOT, JOHN DEERE, MAXION**

Prestolite **UF-4.412** Tipo / Type: **M74R, Com Mola**



Original: K01331 (Delphi / Lucas / Indiel)
Partida / Starter: M74R
Aplicação / Application: **RENAULT, FORD, PEUGEOT, VOLKSWAGEM, CHEVROLET-GM, FIAT**

Prestolite **UF-4.414** Tipo / Type: **M93/100, Sem mola**



Original: K01190 (Delphi / Lucas / Indiel)
Partida / Starter: M93-12V, M100 12/24V
Aplicação / Application: **AGRALE, FORD, CHEVROLET-GM, CUMMINS, VOLKSWAGEM, MERCEDES-BENZ, PEUGEOT, JOHN DEERE, MAXION**

Valeo **UF - 4.418** Tipo / Type: **D7E**



Original: _____
Partida / Starter: D7E- 56, 12V, 2415.198 ED.T
Aplicação / Application: CHEVROLET-GM: CORSA, FORD, VOLKSWAGEN

Valeo **UF - 4.419** Tipo / Type: **D7E**



Original: _____
Partida / Starter: D7E- 34, 12V, D7E- 43, 12V27H4.116 FS, 05L5.068 WAL-F
Aplicação / Application: CHEVROLET-GM: CORSA, VOLKSWAGEN, FORD, RENAULT, CITROEN, PEUGEOT, FIAT: STILO E PALIO 1.8

Valeo **UF - 4.423** Tipo / Type: **D6R**



Original: _____
Partida / Starter: D6RA65 165, D6RA85 185
Aplicação / Application: CHEVROLET-GM: CORSA, RENAULT, PEUGEOT, CITROEN.

Valeo **UF - 4.430** Tipo / Type: **D7R**



Original: _____
Partida / Starter: 0041518901,004151890180,0041519201, 004151920180, 0041519701, 004151970180, 0051511301, 005151130180, 005151130187
Aplicação / Application: MB, RENAULT, MITSUBISHI, HYUNDAI, KIA

Reparos para Garfos Para Motores de Partida
Engaging lever for Starter Motor

Bosch **R - 4.411**



Tipo / Type: **DA, DW, DM**
Partida / Starter: F 000 AL0 401
Aplicação / Application: VOLKSWAGEM: GOL, PARATI GERAÇÃO 2 E 3 COM MOTORES 1.0 MI, 16V E TURBO (09/2001→), PARTIDAS DW E DM, GM, FIAT: DUCATO, FORD

Bosch **R - 4.415**



Tipo / Type: **DM, DW**
Partida / Starter: _____
Aplicação / Application: FIAT, CHEVROLET-GM, NISSAN, TROLLER

Bosch **R - 4.416**

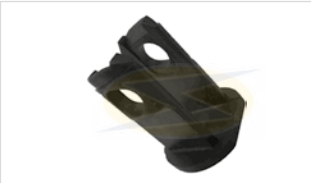

Tipo / Type: **EV**
Partida / Starter: 0 001 223 505, 0 001 223 003, 0 001 223 010, 0 001 231 003, F 002 G20 904, BC45-11001-BA
Aplicação / Application: FORD: CARGO 816 / 1119 / 1319 / 1519 / 1719 / 1729 / 1723 / 2423 / 2429 / 2623 / 2629 / 1317 / 1517 / 1717 / 1722 / 2422 / 2626 / 2628 / 2622 / 2626, MOTOR CUMMINS ELETRÔNICO 24V MOTOR ISC 4.5L E 6.7L (→2010), FIAT: DUCATO, IVECO, MBB

Bosch

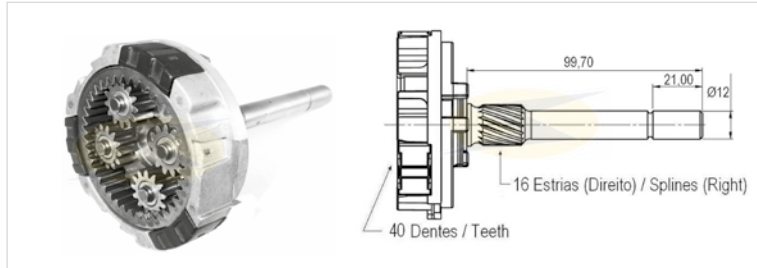

UF-11.003

Tipo / Type: **EV - 12v - 2.3 Kw**

Original: 6 033 AD0 053

Partida / Starter: 0 001 223 001, 0 001 223 009, 0 001 223 010, 0 001 223 013

Aplicação / Application: **FIAT:** DUCATO 10 2.8 TD/ TD EGR (1997→2002), **FORD:** F-250 6CC MWM 6.07 TCA (1999→), **IVECO:** DAILY 12 8140 (1997→), **PEUGEOT:** JUMPER

Bosch

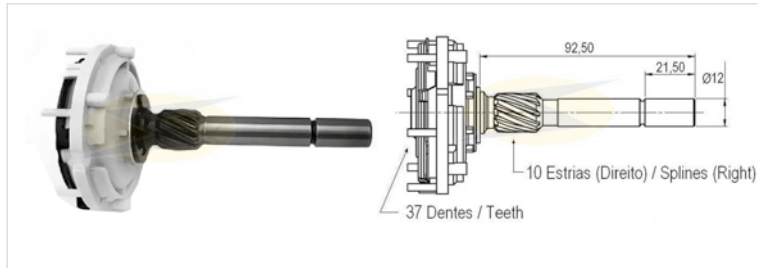

UF - 11.010

Tipo / Type: **DW**

Original: 1 006 200 110

Partida / Starter: 0 001 107 009, 0 001 107 015, 9 000 081 004

Aplicação / Application: **ALFA ROMEO:** ALFA 145-1.6IE, **CHEVROLET-GM:** ASTRA, BLAZER, IPANEMA, KADETT, OMEGA, S-10, VECTRA, ZAFIRA, **OPEL:** ASTRA, CALIBRA, OMEGA, VECTRA

Bosch

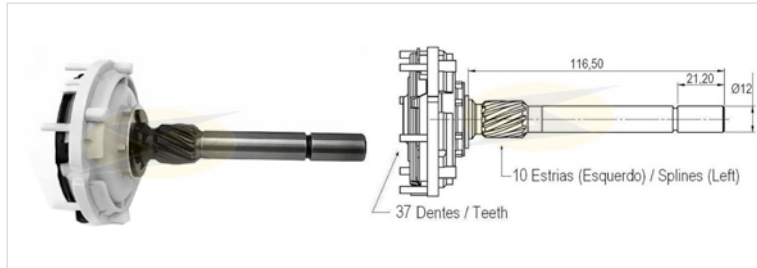

UF - 11.015

Tipo / Type: **DW**

Original: F 000 AL1 015

Partida / Starter: 9 000 081 001, 9 000 081 002

Aplicação / Application: **FORD:** ESCORT 1.6I / 1.8I / 2.0I, VERONA 1.8I / 2.0I, **SEAT:** INCA 1.6 EFI, **VOLKSWAGEN:** LOGUS 1.6 / 1.8 / 2.0 / I / MI / POINTER 1.8 / 2.0 / I / MI / VAN 1.6 MI

Bosch

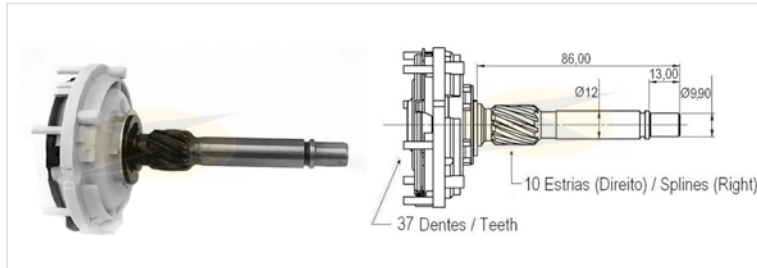

UF - 11.018

Tipo / Type: **DW**

Original: 1 006 200 123 (1 006 200 018)

Partida / Starter: 0 001 108 026, 0 001 108 048, 0 001 108 136, 0 001 108 146, 0 001 108 154, 0 001 108 159, 0 001 109 040, F 005 M00 012, F 005 M00 014

Aplicação / Application: **AUDI:** 100 2.2, 200 2.2 TURBO, **CITROEN:** BERLINGO, XANTIA, XM, XSARA, ZX, **PEUGEOT:** 306, 405, 605, 806, PARTNER, **ALFA ROMEO:** ALFA 155 2.0TS, 156, 164, 166, SPIDER, **FIAT:** CROMA 2.0IE / 16V / TURBO, **JEEP:** CHEROKEE 2.5I, **LAND ROVER:** RANGE ROVER I / II, **HOLDEN:** CALAIS 5.0, CAPRICE 5.0, STATESMAN 5.0, **CHEVROLET-GM:** OMEGA IMPORTADO (AUSTRALIA) 3.8 V6

Bosch

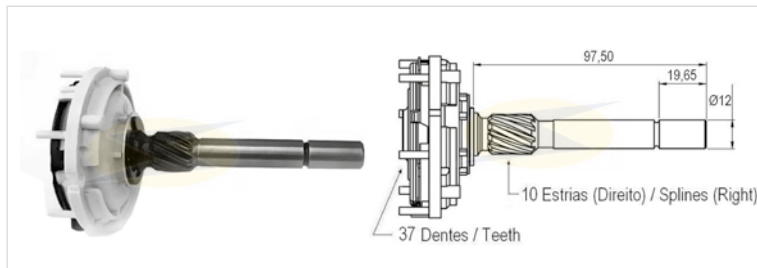

UF - 11.019

Tipo / Type: **DW**

Original: F 000 AL1 019

Partida / Starter: 9 000 081 006, 9 000 081 007

Aplicação / Application: **VOLKSWAGEN:** GOL, PARATI, QUANTUM, SANTANA, SAVEIRO, VOYAGE

Bosch

UF - 11.029

Tipo / Type: _____

Original: 2 337 1F4 029

Partida / Starter: 9 008 046 015

Aplicação / Application: **NISSAN**

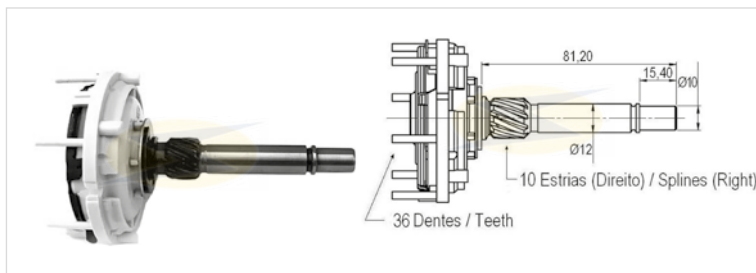

Bosch

UF - 11.037

Tipo / Type: **DW**

Original: F 000 AL1 017, (F 000 AL1 037)

Partida / Starter: 9 000 081 005, 9 000 081 008, F 000 AL0 100

Aplicação / Application: **FIAT: TEMpra 2.0 / MPI / SPI / 8V / 16V / TURBO, PALIO 1.6 16V, PALIO WEEKEND 1.6 16V, TEMpra TURBO 2.0 MPI 8V**

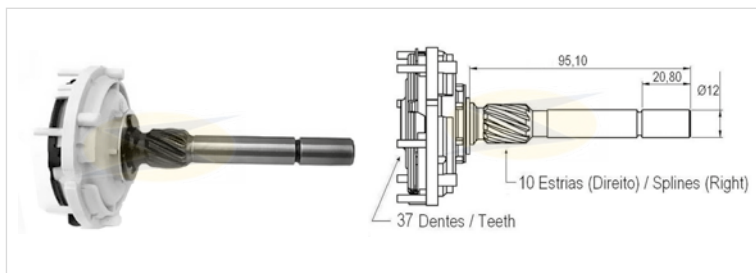

Bosch

UF-11.056

Tipo/Type: **EV 12volts - 2,20 Kw**

Original: 9 001 337 056, (9 003 336 268)

Partida / Starter: 0 001 218 108, 0 001 218 137, 0 001 218 165, 0 001 218 722, 9 000 331 419

Aplicação / Application: **MBB: CLASSE S600 SEC V12 / S 600 (MOTOR 120-982) (09/1996→08/1999), 600 SEL (MOTOR 120.980) (04/1991→05/1993), S600 (MOTOR 120.980) (06/1993→09/1995). SÉRIE MB 100D (MOTOR OM 616.963) (09/1991→01/1996), MB 180D (MOTOR 616) (04/1994→), SSANGYONG: MUSSO 2.9 DIESEL (MOTOR OM 662 D29) (07/1993→)**

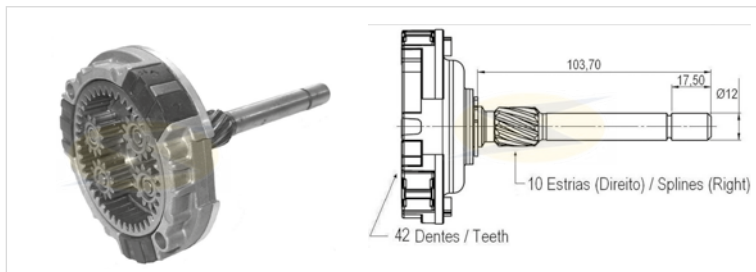

Bosch

UF - 11.058

Tipo / Type: **DW**

Original: 1 006 200 058

Partida / Starter: 0 001 107 045, 0 001 107 145

Aplicação / Application: **OPEL: CALIBRA 2.0i 16V (09/1993→08/1996), ASTRA 2.0i (01/1995→02/1998), CHEVROLET-GM: ASTRA / SEDAN 2.0i 16V (02/1999→07/2001), VECTRA 2.0 16V (04/1996→11/1997), ZAFIRA 2.0 SFI 16V (04/2001→)**

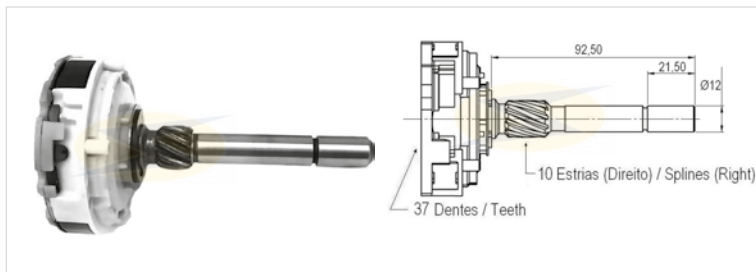

Bosch

UF - 11.059

Tipo / Type: **DW**

Original: 1 006 200 059, (1 006 200 098)

Partida / Starter: 0 001 108 123, 0 001 108 124, 0 001 108 134, 0 001 108 160, 0 001 108 995, 0 001 107 403

Aplicação / Application: **MERCEDES-BENZ: C 180 / T-MODELL / 200 / 220 / 230, CLK 230 K.P., E 230, ML 230, SLK 230 K.R., 124-200E, CHRYSLER, DODGE: DAKOTA 2.5 D, GRAND CARAVAN 2.5, VOYAGER 2.5 / 3.3 / 3.6**

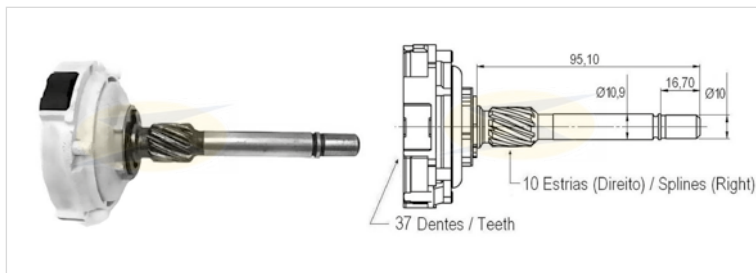

Bosch

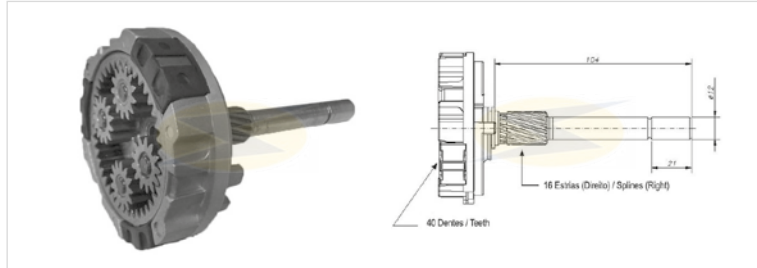

MOTOR / ENGINE DEUTZ BF4M1011F DSL (1997→2000)

UF-11.063 Tipo / Type: **EV**

Original: 6 003 AD0 063

Partida / Starter: 0 001 223 002, 0 001 223 003, 0 001 223 007, 0 001 223 016, 0 001 223

021, 0 001 223 024, (IVECO 48498717, 500307724 504201467, 92901859)

Aplicação / Application: **IVECO:** DAILY 35 / 50 C / S (MOTORES / ENGINES 9 8140.63.4000, 9 8140.63.4030, 9 8140.63.4000, 9 8140.63.4020 / S, 9 8140.63.4030, 11 8140.43C, 13 8140.43S, 11 8140.43C, 13 8140.43S, 11 8140.43C, 13 8140.43S), **DEUTZ:** MOTORES MARÍTIMOS / MARINE ENGINES BF4L1011 (2.71L-2.732CC), F2L1011 (1.4L-1366CC), F3L1011 (2.0L-2049CC), F4L1011 (2.7L-2732CC), **KHD:** MOTORES / ENGINES F2L1011 (1.4L-1366CC) (1995), F3L1011 (2.0L-2049CC) (1995), F4L1011 (2.7L-2732CC) (1995), **THOMAS EQUIPMENT:** MINI CARREGADEIRAS / SKID STEERS T243

Bosch

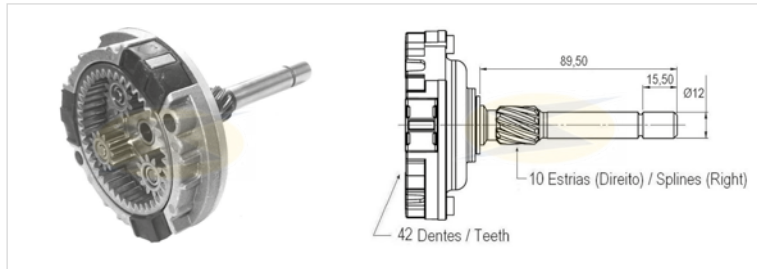

UF-11.067 Tipo/Type: **EV**

Original: 9 001 337 067, (9 001 336 285)

Partida / Starter: 9 000 331 406

Aplicação / Application: **CHEVROLET-GM:** ASTRA, BLAZER, S10, VECTRA - II(SOHC) 1.8 / 2.0 / 2.2 - 8V (→03/2001)

Bosch

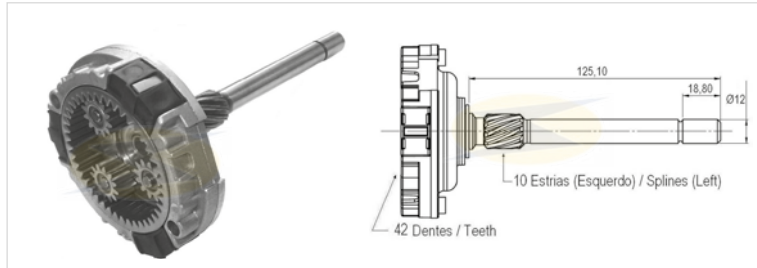

UF-11.073 Tipo / Type: **EV Anti-horário / Counter clockwise**

Original: 9 001 337 073

Partida / Starter: 0 001 218 116, 0 001 218 117

Aplicação / Application: **VOLKSWAGEN:** TRANSPORTER 2.4D, SYNCRO (1990→1994)

Bosch

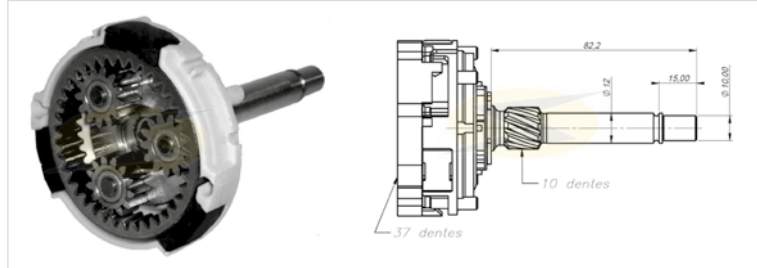

UF-11.079 Tipo/Type:

Original:

Partida / Starter: 0 001 115 079, 0 001 115 078, 55832949, 51832949, 51 832 949 A 152

Aplicação / Application: **FIAT:** DUCATO 2.3 MULTIJET, **PEUGEOT:** BOXER, **CITROEN:** JUMPER MULTIJET DIESEL 2010>

Bosch

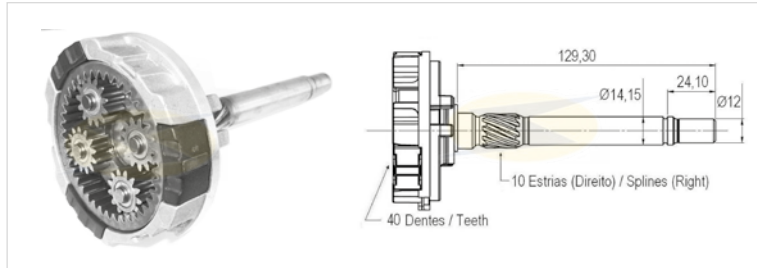

UF-11.090 Tipo/Type: **EV, 12v - 2.6 Kw**

Original: 6 033 AC0 252, 6 033 AD0 090, 6 033 AD0 108

Partida / Starter: 0 001 223 505

Aplicação / Application: **FORD:** F-250 4CC CUMMINS 4BTAA (1998→), F-4000

Bosch

UF-11.099

Original: 1 006 200 099

Partida / Starter: 0 001 109 014, 0 001 109 018, 0 001 109 026, 0 001 109 036, 0 001 109 048, 0 001 110 012, F 000 AL1 401

Aplicação / Application: CITROEN: RELAY 2.8, FIAT: DUCATO 2.3 / 2.8, ULYSSE 1.9TD / 2.1TD (1995→1998), STRADA 1.9D (2000→), STRADA 1.7 TDS (1999→), PUNTO 1.7 D / TD (1995→1999), MB: 410D SPRINTER (1997→2000), 312D SPRINTER (1995→2000), NISSAN: FRONTIER, PEUGEOT: BOXER 2.8

Bosch

UF-11.104

Original: 1 006 200 104 (1 006 200 134)

Partida / Starter: 0 001 107 048, 0 001 108 064, 0 001 108 080, 0 001 108 088, 0 001 108 101, 0 001 108 102, 0 001 108 113, 0 001 108 121, 0 001 108 143

Aplicação / Application: MERCEDES-BENZ: E 190 2.3, 124 - 230 E, BMW: 325i, 525i, CHEVROLET-GM: OMEGA 3.0i / 4.0i, SUPREMA 3.0i / 4.0i, C20, SILVERADO 4.1, OPEL: OMEGA 2.4 I / 2.6 I / 3.0 I / EVOLUTION 500 / 3.6i, VOLVO: 740 2.0 INJECTION, 940 2.3 TURBO, 960 2.3 TURBO INTERC., AUDI: 80 2.2 RS2, 80 2.2 QUATTRO S2, S6 2.2 T, 80 - 2.6 / 2.8, 80 QUATTRO 2.6, 100 - 2.8, A6 2.6, FIAT: BRAVA, FIORINO, MAREA, PALIO, WEEKEND, SIENA, STILO, STRADA, FORD: ESCORT 1.6i 16V / CABRIO / TURNIER / XR3i, MONDEO 1.8i / 2.0i, RENAULT: CLIO 2.0i WILLIAMS, LAGUNA 2.0i

Bosch

UF-11.111

Original: F 000 AL1 974

Partida / Starter: F 000 AL0 111

Aplicação / Application: TOYOTA: HILUX / SW4 D4D 2.5 / 2.8 / 3.0 DIESEL (2006→)

Bosch

UF-11.117

Original: 1 006 200 117 (2.2363.0)

Partida / Starter: 0 001 125 001, 0 001 125 002, 0 001 125 005, 0 001 125 006, 0 001 125 007, 0 001 125 008, 0 001 125 009, 0 001 125 010, 0 001 125 012, 0 001 125 013, 0 001 125 021, 0 001 125 022, 0 001 125 031, 0 001 125 032, 0 001 125 035, 0 001 125 036, 0 001 125 042, 0 001 125 043, 0 001 125 051, 0 001 125 052

Aplicação / Application: AUDI: A2, A3, S3 1.9 TDI, FORD: GALAXY 1.9 / 2.0 / 2.3 / 2.8 TDI / VR6, SEAT: ALHAMBRA, CORDOBA, IBIZA II, LEON, TOLEDO 1.7D / 1.9D / TD / TDI / SDI / V5, SKODA: FABIA, OCTAVIA 1.4TDI / 1.9 SDI / TDI, TDI, MB: V280, VOLKSWAGEN: BORA, CANDYII, CABRIO, CORRADO, EUROVAN, GOLF, JETTA, NEW BEETLE, PASSAT, POLO, SHARAN - MOTORES / ENGI-

MES 1.4 / 1.5D / 1.6D / 1.8GTI / 1.9 SDI / TDI / V5 / V6 / 2.8 VR6 / 2.9 VR6, TRANSPORTER 1.2 / 1.5 / 1.6 / 1.9TD / 2.4D / 2.5 / 2.5 SYNCRO / TDI / 2.8 VR6, VENTO 1.9D / SDI / TD / TDI / VR6

Bosch

UF-11.118

Original: 1 006 200 118, (2.2364.0)

Partida / Starter: 0 001 124 011, 0 001 124 012, 0 001 125 039, 0 001 125 040

Aplicação / Application: SEAT: AROSC 1.7SDI, VOLKSWAGEN: LUPO 1.7 SDI, POLO 1.7 / 1.9D SDI

Bosch

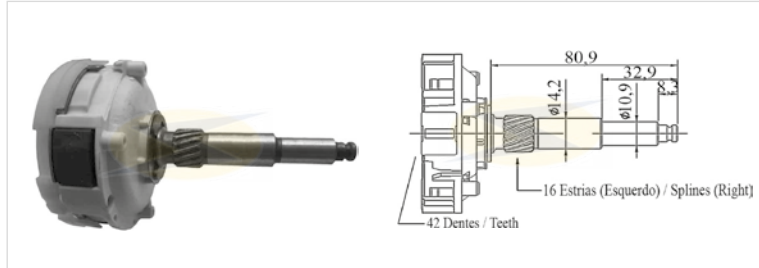

UF - 11.122 Tipo / Type:

Original: 1 006 200 122, (2.235.0)

Partida / Starter: 0 001 125 042

Aplicação / Application: SEAT: ALHAMBRA/ CORDOBA 1.9 TDI (1997→2001), VOLKSWAGEN: GOLF 1.9 TDI (1997→2001)

Bosch

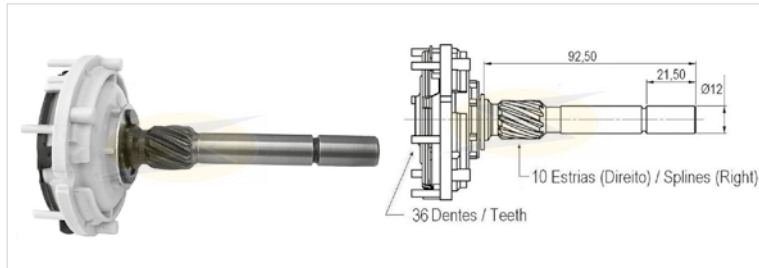

UF - 11.123 Tipo / Type: DW

Original: 1 006 200 121

Partida / Starter: 0 001 107 056 (12V), 0 001 107 100, 0 001 107 101, 0 001 107 108

Aplicação / Application: ALFA ROMEO, AUDI, CITROEN, LANCIA, OPEL, PEUGEOT, RENAULT, SEAT, VAUXHALL, VOLKSWAGEN.

Bosch

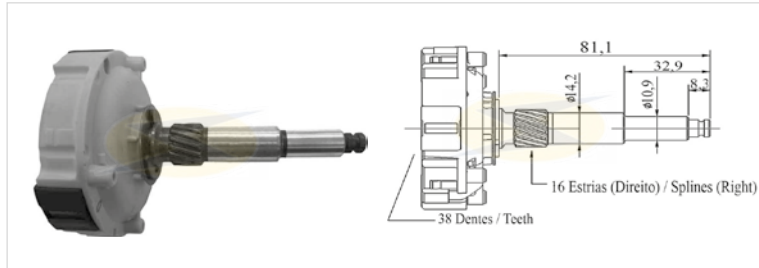

UF-11.126 Tipo/Type:

Original: 1 006 200 126, (2.2366.0)

Partida / Starter: 0 001 125 501, 0 001 125 502

Aplicação / Application: VOLKSWAGEN: LT 2.5 TD (1999→), LT 2.5 TD 4X4 (1985→2001)

Bosch

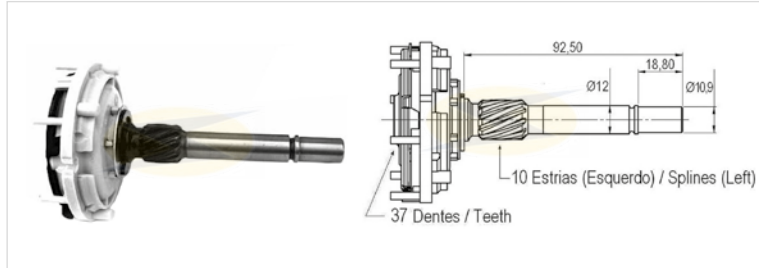

UF - 11.128 Tipo / Type: DW

Original: 1 006 200 128, 1 006 200 043

Partida / Starter: 0 001 107 007, 0 001 107 008, 0 001 107 020, 0 001 107 021, 0 001 107 052, 0 001 107 053

Aplicação / Application: FIAT: TEMPRA 2.0 I.E. S.W., TIPO 1.8 / 2.0 / I.E. /16V, VOLKSWAGEN: GOLF 1.8 / II 1.8 E III 1.8, PASSAT (IMPORT) 2.0, AUDI: A3 1.8 / 1.8T, SEAT: ALHAMBRA, CORDOBA, IBIZA

Bosch

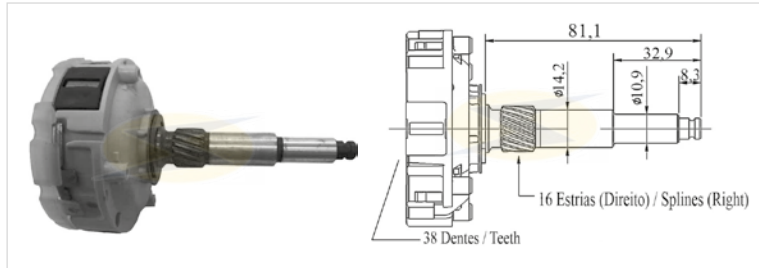

UF-11.143 Tipo/Type:

Original: 1 006 200 143, (2.2367.0)

Partida / Starter: 0 001 123 001, 0 001 124 015, 0 001 125 025, 0 986 022 470

Aplicação / Application: PORSCHE: BOXSTER (1996→2004) 2.5 / 2.7 / 3.2, 911 CARRERA / CARRE- RA 3.6, 912, 996, 997, GT3, CAYENNE 2002

Bosch

UF - 11.145 Tipo / Type: **DW**

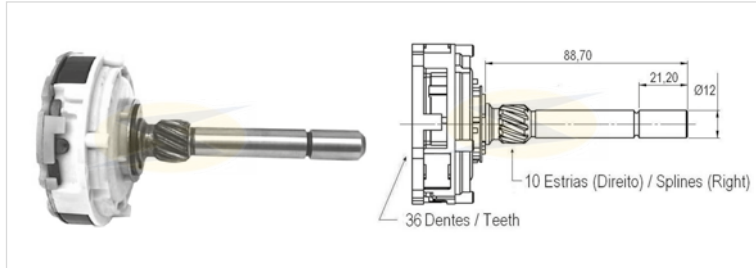

Original: 1 006 200 145

Partida / Starter: 0 001 107 037, 0 001 107 048, 0 001 108 157, 0 001 108 169

Aplicação / Application: **MERCEDES-BENZ, BMW: 328i (1998)**

Bosch

UF - 11.153 Tipo / Type: **DW**

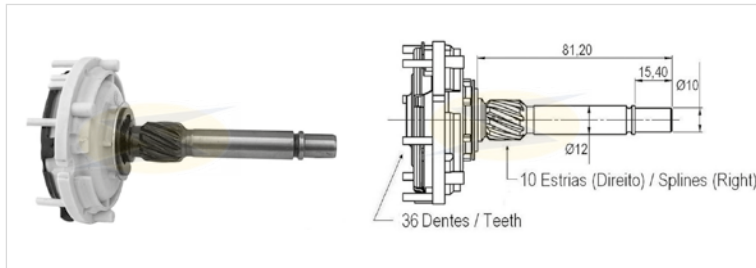

Original: 1 006 200 153

Partida / Starter: 0 001 107 075 – 12v Bosch 183, F 000 AL0 106

Aplicação / Application: **TOYOTA: COROLLA 1.8i 16V (08/1998 → 06/2002)**

Bosch

UF - 11.161 Tipo / Type: **DW**

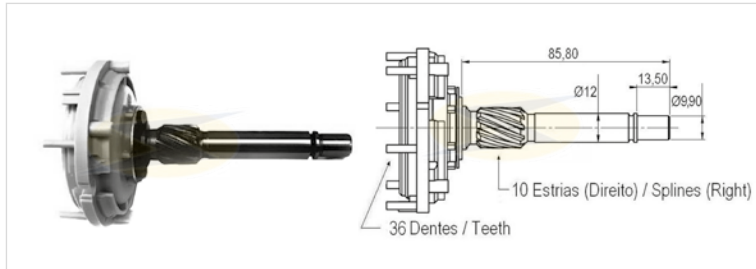

Original: 1 006 200 161

Partida / Starter: 0 001 106 017

Aplicação / Application: **RENAULT: LAGUNA 2.0 I 16V, CLIO 2.0, ESPACE, MEGANE 1.8 / 2.0, SENIC 1.8 / 2.0, TWINGO, KANGOO, VOLVO**

Bosch

UF-11.173 Tipo / Type: **EV**

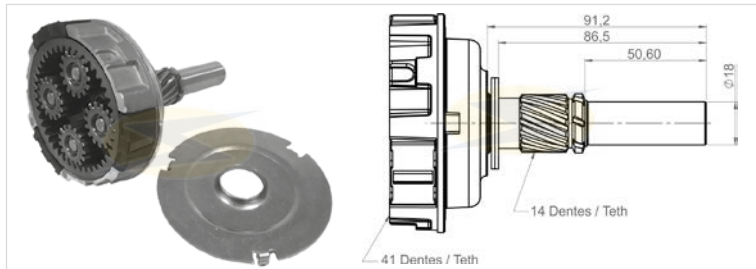

Original:

Partida / Starter: 0 001 241 001, 0986021480

Aplicação / Application: **SCANIA: G 230 / 270 / 280 / 310 / 320 / 340 / 360 / 380 / 400 / 420 / 440 / 470 / 480, K 270 RODOVIÁRIO, K 310 RODOVIÁRIO, K 340 RODOVIÁRIO, K 380 RODOVIÁRIO, K 420 RODOVIÁRIO, P 230 / 270 / 280 / 310 / 320 / 340 / 360 / 380 / 400 / 420 / 470 / 480 / I, R 230 / 270 / 310 / 340 / 360 / 380 / 400 / 420 / 440 / 470 / 480, T 340 / 380 / 420 / 470**

Bosch

UF - 11.181 Tipo / Type: **DB**

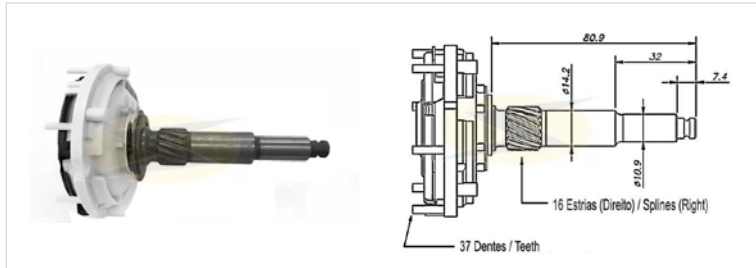

Original: F 000 AL1 181

Partida / Starter: F 000 AL0 502, F 000 AL0 507

Aplicação / Application: **VOLKSWAGEN: GOL, PARATI / II / III 1.8 / 2.0 MI (1996), SANTANA, QUANTUM 1.8 / 2.0 MI (1998), SAVEIRO III 1.6 / 1.8 / 2.0 MI (2000)**

Bosch

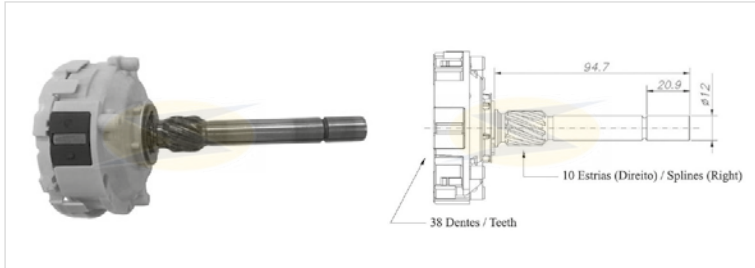

UF - 11.218 Tipo / Type:

Original: 1 006 200 218

Partida / Starter: 0 001 109 300, 0 001 109 301

Aplicação / Application: **CITROEN:** JUMPER 2.8 HDI, JUMPER 2.8 4X4, **FIAT:** DUCATO 2.3 JTD, DUCATO 2.8 DIESEL, DUCATO 2.8 DIESEL 4X4, DUCATO 2.8 JTD, DUCATO 2.8 JTD 4X4, **PEUGEOT:** BOXER 2.8 HDI, BOXER 2.8 HDI 4X4

Bosch

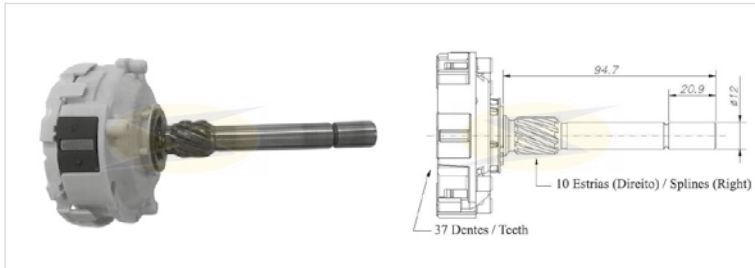

UF - 11.220 Tipo / Type:

Original: 1 006 200 220

Partida / Starter: F 004 A94 008, F 004 A94 011

Aplicação / Application: **TOYOTA:** HILUX D4D, SW4 D4D, YARIS D4D, YARIS VERSO D4D, COROLLA D4D, COROLLA VERSO D4D, AVENSIS D4D, AVENSIS VERSO D4D, RAV4 D4D, LANDCRUISER D4D, PREVIA D4D

Bosch

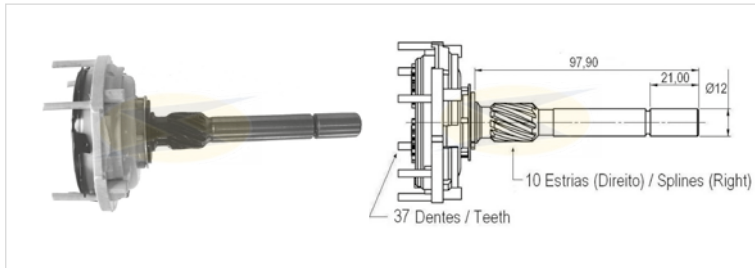

UF - 11.307 Tipo / Type: DW

Original: 1 005 821 307

Partida / Starter: 0 001 108 013, 0 001 108 021, 0 001 108 022, 0 001 108 023, 0 001 108 026, 0 001 108 027, 0 001 108 030, 0 001 108 031, 0 001 108 032, 0 001 108 035, 0 001 108 037, 0 001 108 038, 0 001 108 040, 0 001 108 045, 0 001 108 046, 0 001 108 051, 0 001 108 053, 0 001 108 056, 0 001 108 061, 0 001 108 066, 0 001 108 068, 0 001 108 069, 0 001 108 070, 0 001 108 072, 0 001 108 073, 0 001 108 076, 0 001 108 077, 0 001 108 081, 0 001 108 084, 0 001 108 091, 0 001 108 093, 0 001 108 094, 0 001 108 095, 0 001 108 103, 0 001 108 104, 0 001 108 105, 0 001 108 135, 0 001 108 137, 0 001 108 144, 0 001 108 151, 0 001 108 154, 0 001 108 159, 0 001 109 040

Aplicação / Application: **ALFA:** 156 BERLINA / SPORT WAGON / ALFA 164 / 166 / SPIDER, **AUDI:** 100

1.6 / 200 2.2 TURBO, **CHRYSLER:** GRAND CARAVAN 3.0I LE, **FIAT:** TEMPRA 2.0IE / TIPO 1.8 / 2.0 / IE / 16V, **JEEP:** CHEROKEE 2.5U, **LAND ROVER:** DEFENDER / DISCOVERY / RANGE ROVER I / II, **VOLKSWAGEN:** GOLF 1.8 / II 1.8 / PASSAT (IMP) 2.0, **CHEVROLET-GM:** OMEGA 3.0I / 4.1I / SUPREMA 3.0I / 4.1I / C20, **OPEL:** OMEGA 2.4I / 2.6I / 3.0I / EVOLUT 500 / 3.6, **ALFA ROMEO:** ALFA 156 2.5 24V / SW / 164 2.5 / 3.0 TD / IE / V6 12 / 24V / 166 3.0 / V6 24V / SPIDER 3.0 V6 12V

Bosch

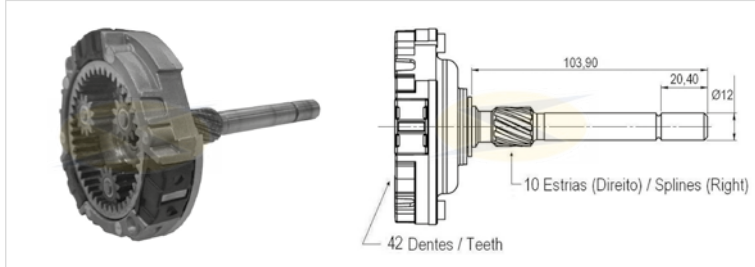

UF-11.590 Tipo/Type: EV 12volts - 2,20 Kw

Original: 9 001 337 059

Partida / Starter: 0 001 218 011, 0 001 218 122, 0 001 218 159, 0 001 218 168, 0 001 218 171, 0 001 218 174, 0 001 218 177, 9 000 331 432, 9 000 331 433

Aplicação / Application: **OPEL:** FRONTERA 2.3 TD (MOTOR 23 DTR TURBO), OMEGA 2.3 TD (MOTOR 23DTR) (09/1988→03/1994), (MOTOR 23YDT) (09/1986→08/1988), **FIAT:** DUCATO 10 2.5 D (MOTOR 8140.67) (03/1994→03/1998) E TD EGR (MOTOR 8140.47) (03/1994→03/1998), **MBB:** 310D SPRINTER (MOTOR OM014A) (1996→), 312D (MOTOR OM014LA) (08/1999→), 412D (MOTOR OM014LA) (10/1999→), **LAND ROVER:** DEFENDER 2.5 TURBO DIESEL (MOTOR GEMINI TCI DI 23L) (08/1990→12/2001), (MOTOR MAXION HS4TCC) (08/1998→), **DISCOVERY 2.5 TDI** (MOTOR 12L / 21L)

(09/1989→09/1994), (MOTOR 19L) (10/1993→12/1998), **RANGE ROVER I 2.5 TDI CLASSIC** (MOTOR 14L) (10/1992→09/1994), (MOTOR 300 TDI) (10/1994→04/1996), **RANGE ROVER II 2.5 DT/DSE** (MOTOR M51-D25) (09/1994→09/2002), **IVECO:** DAILY 10 (MOTOR 8140) (11/1997→), **DODGE:** DAKOTA 2.5D (MOTOR MAGNUM 2.5 L-4) (10/1998→), **FORD:** F-1000 (10/1995→), F-1000 HSD (10/1995→), **CHEVROLET-GM:** BLAZER 2.5 DIESEL (MOTOR 4A) (08/1997→), **RENAULT:** JUMPER

Delco

UF-14.032

Tipo/Type: **28MT (Acompanha rolamento / bearing include)**

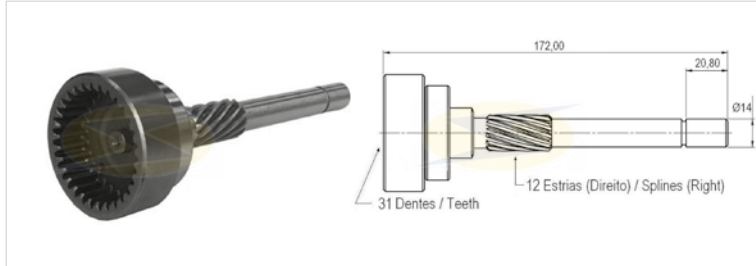

Original: 10457032 (Eixo curto / Short Shaft: 172 mm)

Partida / Starter: 1113276, 113277, 113291, 10479605, 10479623, 10479629, 10479634, 10479643, 10479644, 104796651, 10479652, 10479564, 10479655, 10479645

Aplicação / Application: **AGCO:** ARG. DICUMAR 6BT-F700, DYNAPAC, G-DRIVE, INGERSOLL RAND 95 / 110 / 125, METALFOR PULVERIZADOR, MULLER DTV140, SKIDER, TM-14, ZANELLO, TIMBER-JACK 610 FORWARDER, 450C, 480C (MOTOR CUMMINS 4B3.9, 4BT3.9, 6B5.9, 6BTAA) **TIMBERJACK:** 608, 608 HARVESTER, CIBER VIBRADOR, KOMATSU PC200 ESCAVADEIRA (MOTOR CUMMINS 4B3.9 / 4BT3.9 / 6B5.9 / 6BT5.9 / 6BTAA), FIAT: ALLIS (MOTOR CUMMINS 6BT5.9 COM EMBREAGEM

BANHADA A ÓLEO), GRADER PG140 E PG160 (MOTOR FORD 7.5L GMA, PÁ CARREFADEIRA FR128 E TRATOR DE ESTEIRA 7D, GRADER FG-1402.2, CASE GRADER 845 E 845.2, PÁ CARREGADEIRA W20, FD 170, CREMALHEIRA A BANHO DE ÓLEO), **FORD:** F12000 E F14000 (MOTOR CUMMINS B 5.9 LITROS 160CV), **CASE:** RETROESCAVADEIRA 580L E 580L SE, **CUMMINS:** 4B3.9, 4BT3.9, 6B5.9, 6BT5.9, 6BTAA, **MBB:** 710, 1418R, 1720, 1720K, L 1620, LO 814 (MOTOR OM 364 E OM 366 EM 12V), OF 1721, OH 1420, OH 1621L, OH 1623 (MOTOR OM 364 E OM 366 EM 24V), **TRATORES:** 5410 (MOTOR 4045D 4 CIL. 4,5L), TRATORES 2140, 2850, 3140, 3350, 3540, 3550 (MOTOR 6359 E 4239D), TRATORES 1420, 2330, 2420, 2530, 2730 (MOTOR 3 E 4 CIL.), TRATORES 5600, 5700 E 6300 (MOTOR 4039D E T 4 CIL. 3,9L), TRATORES 6600 (MOTOR 6059T 6 CIL. 9L), TRATORES 627, 727, 3420, 3530, 4420, 4530, (MOTOR 6 CIL.)

Delco

UF - 14.095

Tipo/Type: **38MT - (IMPULSOR NÃO INCLUSO / START DRIVE NOT INCLUDED)**

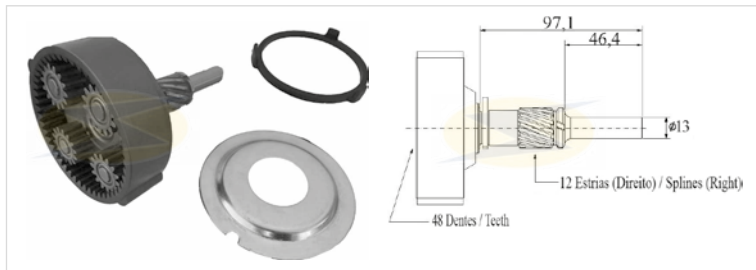

Original: 10512095

Partida / Starter: 8200005, 8200025, 8200053, 8200072, 8200077, 200078, 200356

Aplicação / Application: **CUMMINS:** MOTORES C E ISC DE 8,3 LITROS, **FORD:** CARGO 1622 / 1630 / 2422 / 2425 / 2622 / 2626 / 2630 / 2631 / 3222 / 4030, COM MOTOR CUMMINS 6CTAA 8,3 LITROS, CARGO ELETRÔNICO 2632 / 2932 / 532 / 5032, **VOLKSWAGEN:** CAMINHÕES 17-220 / 17-310 / 23-210 / 23-220 / 23-310 / 24-220 / 26-220 / 26-260 / 26-310, COM MOTOR CUMMINS 6CTAA 8,3 LITROS, CAMINHÕES 31-370 / 25-370 / 19-370 COMO MOTOR 9,3 LITROS INTERNATIONAL E 18-310, 19-320, 31-320, TITAN TRACTOR E CONSTELLATION COM MOTOR CUMMINS ISC 8,3 LITROS, ÔNIBUS 19320EOT – QUÉOPS EVOLUTION COM MOTOR CUMMINS ISC 8,3 LITROS, CAMINHÕES

18.310 TITAN TRACTOR

Delco

UF - 14.150

Tipo/Type: **PG150S**

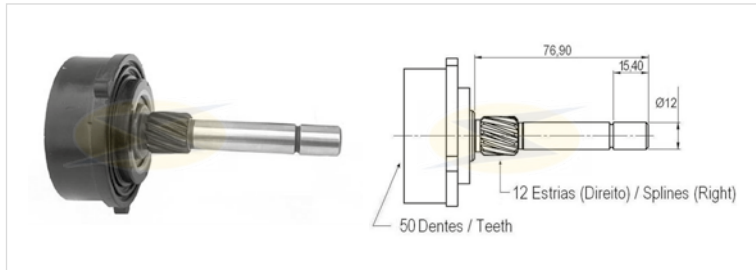

Original:

Partida / Starter: 9000846, 9000794

Aplicação / Application: **CHEVROLET-GM:** ASTRA, BLAZER, S10, VECTRA - II(SOHC) 1.8 / 2.0 / 2.2 / 2.4- 8V (→03/2001), MONZA, ZAFIRA, VECTRA GT, **DAEWOO:** ESPERO 2.0

Delco

UF-14.357

Tipo/Type: **28MT (Acompanha rolamento / bearing include)**

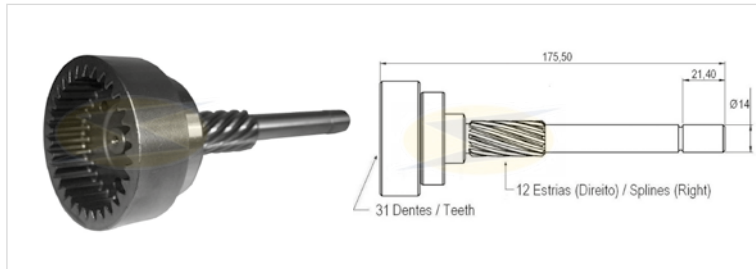

Original: 10457357 (Eixo Longo / Long Shaft: 175.5mm)

Partida / Starter: 10479650 (24v)

Aplicação / Application: **MBB:** 712C, 715, 914C, 915C, 1215, 1218EL, 1218L, 1418EL, 1418L, 1718, 1725, 2423, 2428, LO 914, O 500M, O 500U, OF 1417 COM MOTORES OM 904 E OM 906 ELETRÔNICO EM 24V

Delco

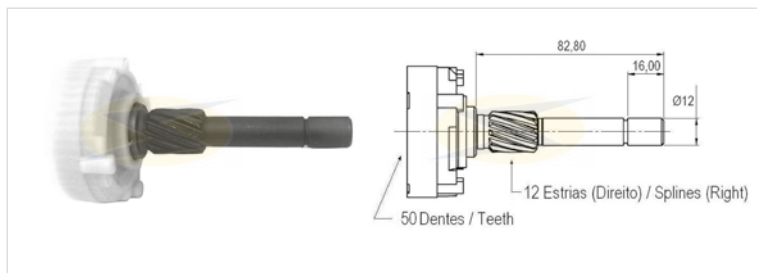

UF-14.368

Tipo/Type: **PG260B,C,D**

Original: 10504495

Partida / Starter: 9000890, 9000891, 9000893, 9000944, 9000948, 9000978, 9000981, 8000006, 8000090, 8000158, 8000159, 8000188, 93374341, 93374342

Aplicação / Application: **CHEVROLET-GM:** AGILE, ASTRA, BLAZER, CELTA, COBALT 1.0 / 1.4 / 1.6, CORSA / PICKUP, NOVO CORSA, CORSA CLASSIC, MONTANA, PRISMA, S10, VECTRA - II(SOHC) 1.8 / 2.0 / 2.2 8V (03/2001→), II(DOHC) 2.0 / 2.2 16V

Delco

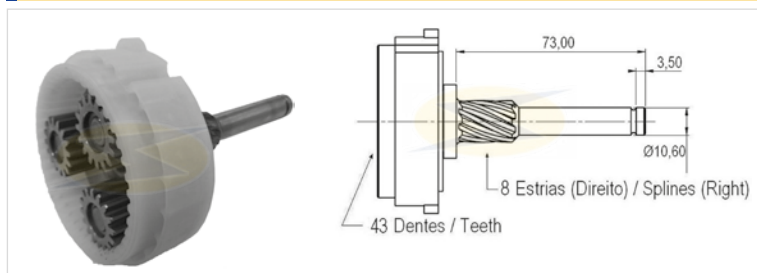

UF-14.711

Tipo/Type: **PG260D, PG245**

Original:

Partida / Starter: 10455711

Aplicação / Application: **CHEVROLET-GM:** OMEGA GLS (1995→1998), OMEGA CD 6CC 4.1 MPFI, SUPREMA CD 6CC 4.1 MPFI

Delco

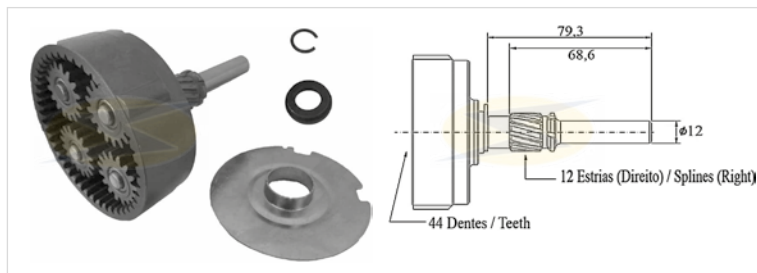

UF-14.811

Tipo / Type: **29MT**

Original: 10515811, 10515810, 10518783

Partida / Starter: 8200003, 8200004, 8200054, 8200064, 8200138, 8200196, 8200231, 8200292, 8200295, 8200296, 8200297, 8200326, 8200331, 8200357, 8200386, 8200474, 8200478, 8200495, 8200511, 8200512

Aplicação / Application: **CNH, FORD, MERCEDES-BENZ, VOLVO, VOLKSWAGEN**

Obs: Esta é a planetária 29MT conjunto antigo: Relação 6/12 [6 estrias impulsor (BZM 9999) / 12 estrias planetária]. Temos a Planetária 29MT conjunto moderno (UF-14.812): Relação 7/14 [7 estrias impulsor (ZEN 1679) / 14 estrias planetária].

Notes: Planetary Gear for 29MT old model: Gear ratio 6/12 [6 splines Drive (BZM 9999) / 12 splines Planetary Gear] We have the Planetary Gear for 29MT new model (UF-14.812): Gear ratio 7/14 [7 splines Drive (ZEN 1679) / 14 splines Planetary Gear].

Delco

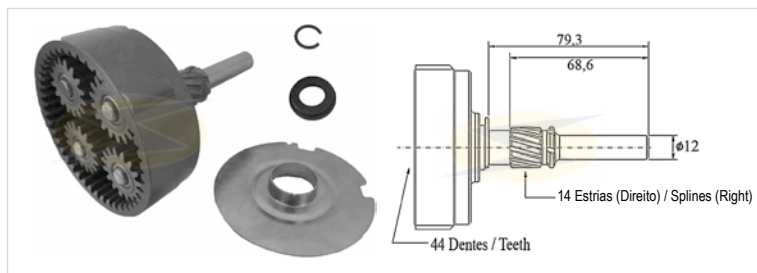

UF-14.812

Tipo/Type: **29MT**

Original: 10515811 (Com 14 estrias / with 14 splines), 10515810 (Com 14 estrias / with 14 splines)

Partida / Starter: 8200003, 8200004, 8200054, 8200064, 8200138, 8200196, 8200231, 8200292, 8200295, 8200296, 8200297, 8200326, 8200331, 8200357, 8200386, 8200474, 8200478, 8200495, 8200511, 8200512, 8000090, 8000158, 8000159, 8000188, 93374341, 93374342

Aplicação / Application: **CNH, FORD, MERCEDES-BENZ, VOLVO, VOLKSWAGEN**

Obs.: Esta é a planetária 29MT conjunto moderno: Relação 7/14 [7 estrias impulsor (ZEN 1679) / 14 estrias planetária]. Temos a Planetária 29MT conjunto antigo (UF-14.811): Relação 6/12 [6 estrias impulsor (BZM 9999) / 12 estrias planetária].

Notes: Planetary Gear for 29MT new model: Gear ratio 7/14 [7 splines Drive (ZEN 1679) / 14 splines Planetary Gear] We have the Planetary Gear for 29MT old model (UF-14.811): Gear ratio 6/12 [6 splines Drive (BZM 9999) / 12 splines Planetary Gear].

Delco

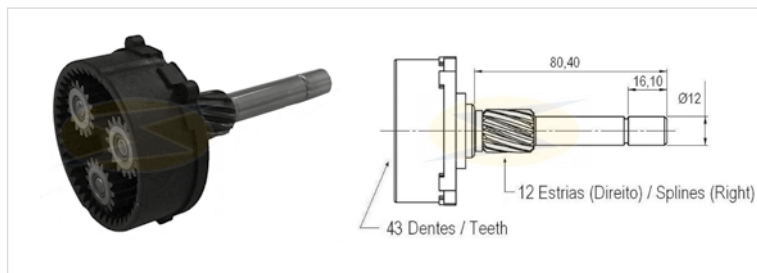

UF-14.890

Tipo/Type: **PG260G**

Original: 10492410

Partida / Starter: 8000014, 9000973, 9000871

Aplicação / Application: **CHEVROLET-GM:** BLAZER E S-10 C/ MOTOR VORTEC V6 4.3

Delco

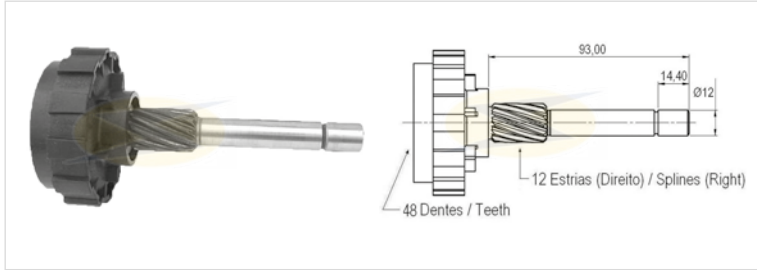

UF - 14.910 Tipo/Type: **PG260M / PMGR**

Original: 10475626

Partida / Starter: 9 000 786, 9 000 798, 9 000 804, 9 000 805, 9 000 806, 9 000 812, 9 000 819, 9 000 820, 9 000 821, 9 000 827, 9 000 834, 9 000 835, 9 000 844, 9 000 850, 9 000 851, 9 000 853, 9 000 860, 9 000 861, 9 000 862, 9 000 863, 9 000 864, 9 000 866, 9 000 867, 9 000 899, 9 000 900, 9 000 910, 10476598

Aplicação / Application: **CADILLAC:** ESCALADE 5.7 V8, **CHEVROLET-GM:** ASTRA, BLAZER, C1500, C1500 SUBURBAN, C2500, C2500 SUBURBAN, C3500, C3500HD, EXPRESS 1500, EXPRESS 2500, EXPRESS 3500, G20, G30, K1500, K1500 SUBURBAN, K2500, K2500 SUBURBAN, K3500, P30, S10,

S10 BLAZER, SILVERADO 2500, SILVERADO 2500 HD, SILVERADO 3500, SUBURBAN 2500, TAHOE, (ALL ENGINES (1989→2000): 4.3 V6 262 CID / 5.0 V8 305 CID / 5.7 V8 350 CID / (1989→2000): 7.4 V8 454 CID, **CLARK, GMC:** C1500, C1500 SUBURBAN, C2500, C2500 SUBURBAN, C3500, C3500HD, G2500, G3500, JIMMY, K1500, K1500 SUBURBAN, K2500, K2500 SUBURBAN, K3500, P3500, S15, S15 JIMMY, SAFARI, SAVANA 1500 / 2500 / 3500, SIERRA, 2500 HD, SIERRA 3500, SONOMA, YUKON, YUKON XL 2500, (ALL ENGINES (1989→2000): 4.3 V6 262 CID / 5.0 V8 305 CID / 5.7 V8 350 CID / (1989→2000): 7.4 V8 454 CID, **ISUZU:** HOMBRE 4.3L V6 (1996→1998), **OLDSMOBILE:** BRAVADA 4.3L V6 (1996→1998)

Ford / Motorcraft

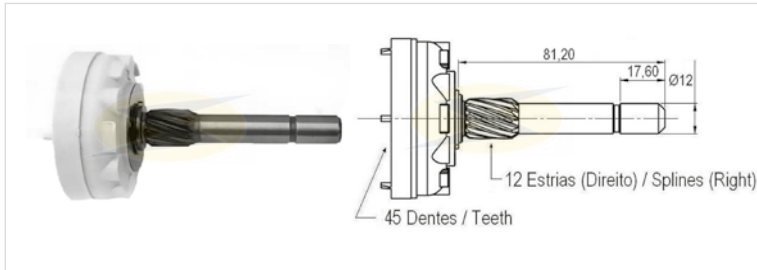

UF - 13.119 Tipo/Type:

Original: 96FB11000

Partida / Starter: 96BB 11000 AA 7.119 BI

Aplicação / Application: **FORD:** ESCORT, FIESTA, KA, MONDEO, COUGAR, FOCUS

Ford / Motorcraft

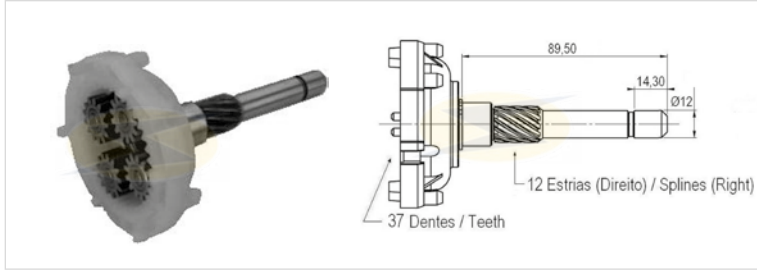

UF - 13.120 Tipo / Type:

Original:

Partida / Starter: F8TU-11.000 DD 9251-AI

Aplicação / Application: **FORD:** RANGER V6 4.0, ECOSPORT, EXPLORER V6 4.0 GAS.

Ford / Motorcraft

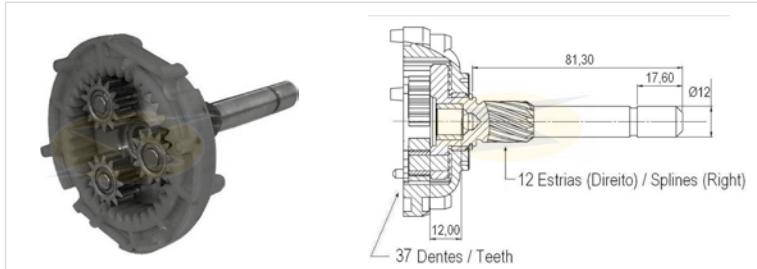

UF - 13.121 Tipo/Type: (Eixo curto / Short Shaft)

Original:

Partida / Starter: F07UAA716A

Aplicação / Application: **FORD:** RANGER V6 4.0 GAS., EXPLORER V6 4.0 GAS.

Ford / Motorcraft

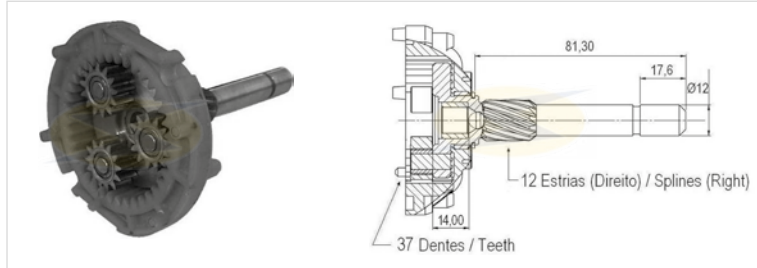

UF - 13.122

Tipo/Type: (Eixo Longo / Long Shaft)

Original: _____

Partida / Starter: F2TUAAC27A

Aplicação / Application: **CHEVROLET-GM:** ASTRA, BLAZER, S10, VECTRA - II(SOHC) 1.8 / 2.0 / 2.2 - 8V (→03/2001)

Mitsubishi

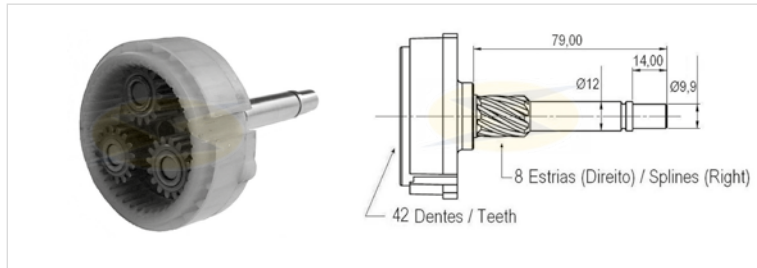

UF - 15.100

Tipo / Type: _____

Original: MOT0081, 80381, 80881, 80981, 81081

Partida / Starter: M000T92581

Aplicação / Application: **CHEVROLET-GM:** S-10, **ISUZU:** C-240 DIESEL ENGINES, **MAZDA:** EMPILHADEIRA / **FORKLIFT,** FP13-18-X56 - MXS MIATA, PROTEGE, MPV, **mitsubishi:** EMPILHADEIRA / **FORKLIFT,** **NISSAN,** VOLARE: MICRO ÔNIBUS, **YALE:** EMPILHADEIRA / **FORKLIFT**

Mitsubishi

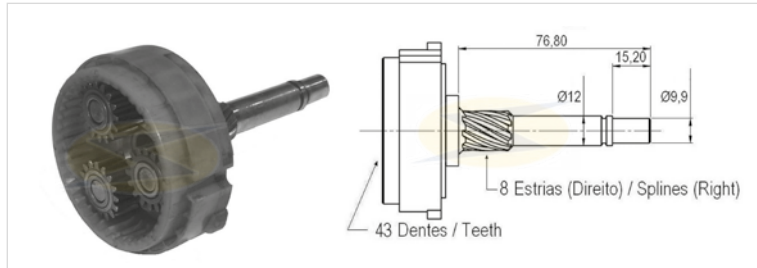

UF-15.101

Tipo/Type: _____

Original: _____

Partida / Starter: M001T79781 12V

Aplicação / Application: **CLARK:** EMPILHADEIRA / **FORKLIFT,** **HYUNDAI:** SONATA, **mitsubishi:** EMPILHADEIRA / **FORKLIFT,** PAJERO V6 GAS, **VOLARE:** ELETRÔNICO

Mitsubishi

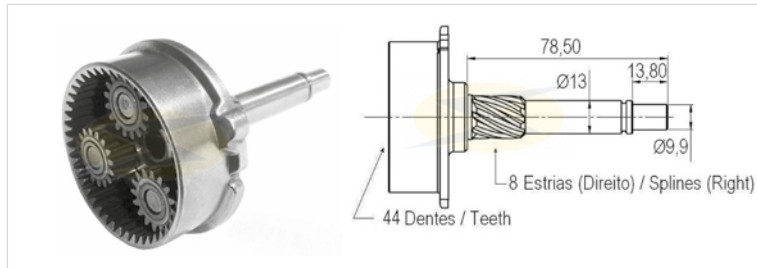

UF - 15.103

Tipo/Type: _____

Original: MOT0081, 80381, 80881, 80981, 81081

Partida / Starter: M 002 T87 771, M 002 T87 171 ZT

Aplicação / Application: **CHEVROLET-GM:** S-10 C/ MOTOR MWM 4 CC 2.8 SPRINT, **mitsubishi:** L200 SPORT HPE, L300, **TROLLER:** T4 2.8 TD MWM 4 CC SPRINT (2001→), **VOLARE**

Mitsubishi

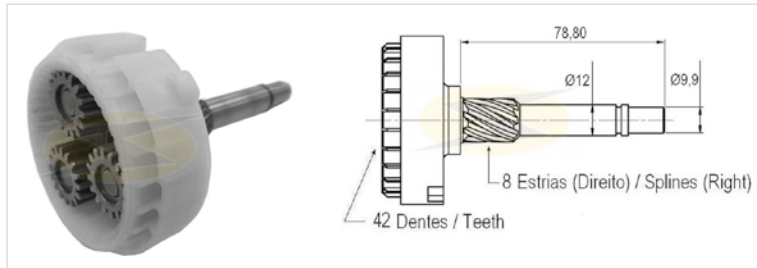

UF-15.104

Tipo/Type: _____

Original: _____

Partida / Starter: _____

Aplicação / Application: **HYSTER:** EMPILHADEIRA / **FORKLIFT,** **RENAULT**

Mitsubishi

UF-15.105

Tipo/Type: **4M40**

Original: 14037, 14038, 14039, 14068

Partida / Starter: M008T75071A, ME20442

Aplicação / Application: **MITSUBISHI:** PAJERO FULL 4CC 2.8 TURBO DIESEL (MOTOR / ENGINE 4M40), MONTERO FULL 4CC 2.8 TURBO DIESEL (MOTOR / ENGINE 4M40), SHOGUN II / III / CLASSIC 4CC 2.8 DIESEL (MOTOR / ENGINE 4M40), GALANT MK VI, CANTER FLATBED

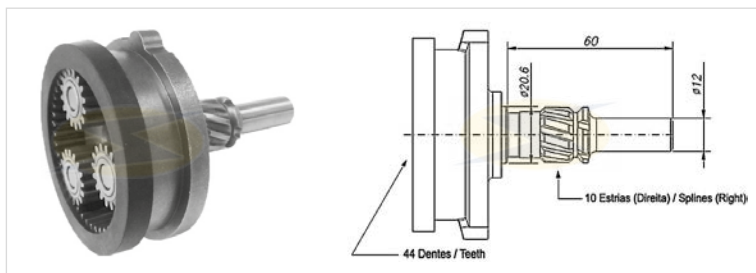

Mitsubishi

UF-15.106

Tipo/Type: _____

Original: _____

Partida / Starter: M9T62572ZA, M9T62671, M9T661171, M9T61671

Aplicação / Application: **IVECO:** EUROSTAR 190 / 260 / 440, EUROTCH 190 / 260 / 440, EURO-TRAKKER 190 / 260 / 340 / 380 / 400 / 410 / 440 / 720, STRALIS 190 / 260 / 400 / 440, STRALIS L 190 / 260 / 440, TRAKKER 190 / 260 / 340 / 380 / 400 / 410 / 440 / 720, TRAKKER N 190 / 260 / 340 / 380 / 400 / 410 / 440 / 720, **FORD:** L6000 / 7000 / 8000 / 9000 C/ MOTOR CUMMINS ISM DE 1985 A 1999, **FREIGHTLINER:** C/ MOTOR CATERPILLAR DE 1999 A 2007, **VOLVO:** VHD SERIES DE 1998 A 2003 CUMMINS ISM, VNM SERIES DE 1997 A 2003 CUMMINS ISM, WA / WC / WG / WH / WI / WX

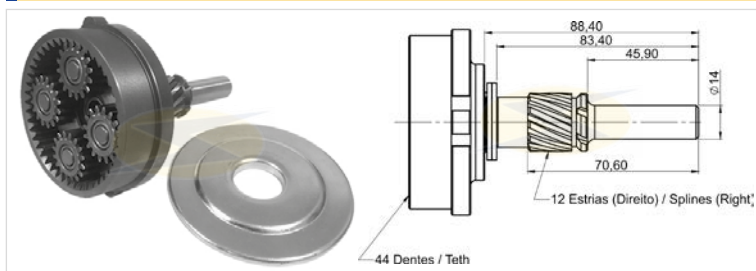

SERIES DE 1997 A 2001 CUMMINS ISM, 9700 / 9900, B 12 B / FH 12 340 / 12 380 / 12 420 / 12 460 / 12 500, FH 380 / 400 / 420 / 440 / 460 / 480 / 500 / 520 / 540, FM 12 340 / 12 420, FM 360 / 380 / 400 / 420 / 440 / 460 / 480 / 500, **VW:** 13-180 / 15-180 / 17-210 / 17-240 / 17-260 / 26-260 / 31-260 / 24-280, CONSTELLATION

Mitsubishi

UF-15.107

Tipo/Type: _____

Original: _____

Partida / Starter: M9T82171, M9T80472

Aplicação / Application: **MB:** AXOR 2035 / 2040 / 2044 / 2540 / 2544 / 2640 / 2644 / 3340 / 3344, ACTROS 1832 / 1846 / 1850 / 1854 / 1858 / 2032 / 2046 / 2050 / 2054 / 2532 / 2546 / 2550 / 2554 / 2558 / 2632 / 2646 / 2650 / 2654 / 2658 / 3232 / 3246 / 3332 / 3346 / 3350 / 3354 / 3358 / 4146 / 4150, ACTROS BLUETEC 1832 / 1836 / 1841 / 1844 / 1846 / 1848 / 1851 / 1855 / 1860 / 2032 / 2036 / 2041 / 2044 / 2046 / 2048 / 2051 / 2055 / 2532 / 2536 / 2541 / 2544 / 2546 / 2548 / 2551 / 2555 / 2560 / 2632 / 2636 / 2641 / 2644 / 2646 / 2648 / 2651 / 2655 / 3232 / 3236 / 3241 / 3244 / 3246 / 3248 / 3332 / 3336 /

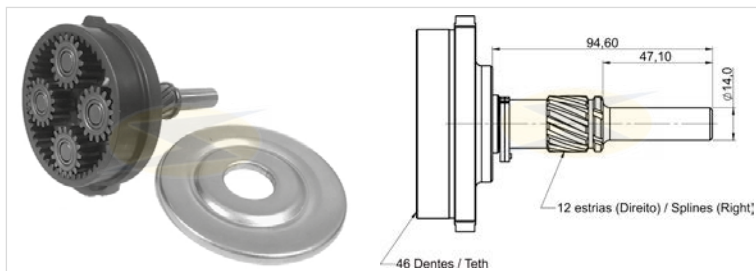

3341 / 3344 / 3346 / 3348 / 3351 / 3355 / 3360 / 4141 / 4144 / 4146 / 4148 / 4151, ACTROS 1861 BLACK EDITION, LS 1634, O 345 G, O 500 MA, O 500 RS-RSD, O 530 GN3 (CITARO), O 530 CN3 UESTRA (CITARO), O 530 GNUE3 (CITARO), O 530 N3 (CITARO), O 530 N3 LANG (CITARO), O 580 RHD-17 (TRAVEGO), TOURISMO 15 RHD/SHD

Prestolite

UF-12.100

Tipo/Type: **M100R**

Original: K01497

Partida / Starter: 35259200, 35259260, 35259290, 35259340, 35259360, 35259440, 35259450, 35259460, 35259520, 35259550, 35259730, 35259770, 35259780, 35259810, 35259830, 35259840, 35260830, 35260840, 35260870, 35261000, 35261050, 35261130, 35261160, 35261185, 35261900, 35262010

Aplicação / Application: **AGRALE:** MARRUÁ MWM SPRINT 4.07, **CATERPILLAR:** BLUE BIRD USA CAT 3126 7.2 - BLUE BIRD USA CAT 3126 7.2 (OCP), **CUMMINS:** CUMMINS ISB02 5.8 - CUMMINS C 8.3 CUMMINS B, **JOHN DEERE:** 7820 6081H 6 CIL. CEIFEIRA 1550 6081H 6 CIL. 8.12 - TRATOR 6 CIL. **FORD:** CUMMINS B 5.9, CARGO 2422 / 2425 / 2630 CUMMINS 6CTAA 8.3 - CARGO 2425 MIXER

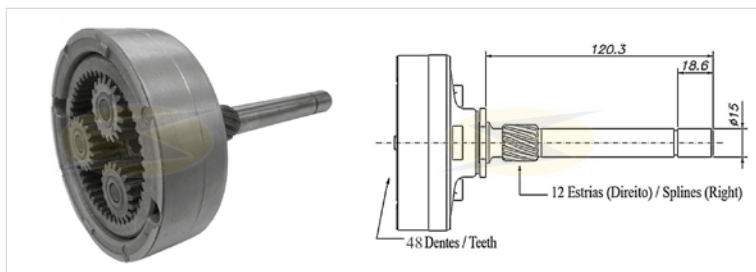

CUMMINS 6CTAA 8.3, **FREIGHTLINER:** NAVISTAR V8 7.3, **GRADALL:** TRATOR 4045 JOHN DEERE 4 CIL. 4.5, **INTERNACIONAL ENGINES:** CAMINHÃO NAVISTAR DT446 - I6 7.6 - DT444E - V8 7.3 - DT-360 5.9, **VALTRA:** TRATOR BH140 / BH160 / BH180 SISU 6CIL. - TRATOR BL77 SISU 3CIL. - TRATOR BI88 SISU 4 CIL. - TRATOR BM100 / BM120 SISU 4CIL. - TRATOR LIVIANO 685C / 785C MWM 3 CIL. - TRATOR PESADO 1280 / 1580 MWM 6 CIL. - TRATOR PESADO 1780 MWM 6, **MBB:** O371 6 CIL. - OF215 6 CIL. - ÔNIBUS 1214 / 1414 / 1418 / 1614 CAIXAAUTOMÁTICA, **PAUNI:** MINIBUS CUMMINS 4BT 3.9, **MWM:** 4 E 6 CIL. - MWM SERIES X10 E 229 SERIES, **VW ÔNIBUS:** ÔNIBUS MWM 4 E 6 CIL., **VOLVO:** LÍNEA VM: VM17 MWM SERIES X10 E 229 SERIES - LÍNEA VM: VM23 MWM SERIES X10 E 229 SERIES

Prestolite

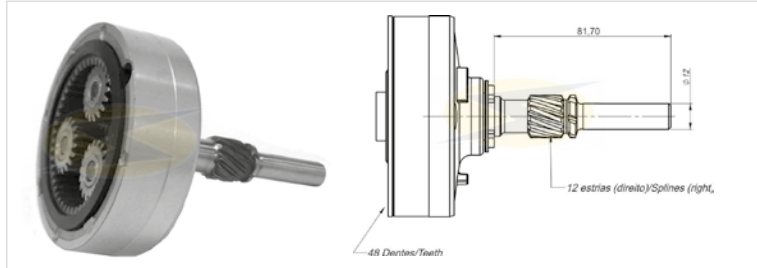

UF-12.101

Tipo / Type: M100R 12V

Original: K01561 / K1561

Partida / Starter: 35261345, 35259500, 35259820, 35260900, 35260910, 35261385, 35261680, 35261690

Aplicação / Application: **JOHN DEERE:** TRATORES / TRACTORS 6405 / 6605 / 6600 / 7505 / 7515 / 6405 / 6415 / 7185 / 185J / 180J / 165J / 7165 / 7180 / 7215J, COLHEITADEIRAS 6 CILINDROS / COMBINE 6 CYLINDERS

Prestolite

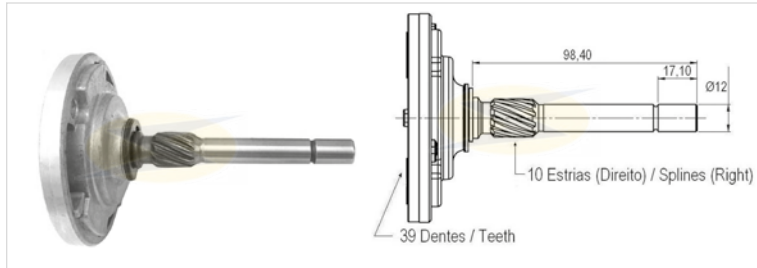

UF-12.147

Tipo / Type: M93R

Original: 352.58.669, (K21147)

Partida / Starter: 352.58.580, 352.58.940, 352.58.950, 352.58.490, 352.58.540, 352.58.660, 352.58.690, 352.58.710, 352.58.820, 352.58.880, 352.58.960, 352.59.040, 352.59.050, 352.60.828, 352.61.860

Aplicação / Application: **AGRALE:** ÔNIBUS VOLARE, **CHEVROLET-GM:** BLAZER DLX, PICK-UP S10 C/ MOTOR MAXION HS, PICK-UP D20, SILVERADO C/ MOTOR MWM, **CUMMINS:** MOTORES SÉRIES 6BT (DIANTEIRO) / B6 / BT5.9L, **FORD:** CARGO 1416 / 1722 / 1716, F-1000, F-14000 C/ MWM, F-100, RANGER 2.5 / 2.8 / 3.0, **JOHN DEERE:** TRATORES, **MASSEY-FERGUSON:** TRATOR C/ MOTOR 4 CIL., **MAXION:** MOTORES, **MERCEDES-BENZ:** 180D - KOMBI ESPANHOLA, ÔNIBUS, CAMINHÕES, MB

180 D, SPRINTER C/ MOTOR MAXION HS, **PERKINS:** MOTORES 4.203 / 3.152 / 4.236 / 6.354, **PEUGEOT:** 504, 505, VÁRIOS C/ MOTOR INDENOR, **VOLKSWAGEN:** CAMINHÃO 15-160

Prestolite

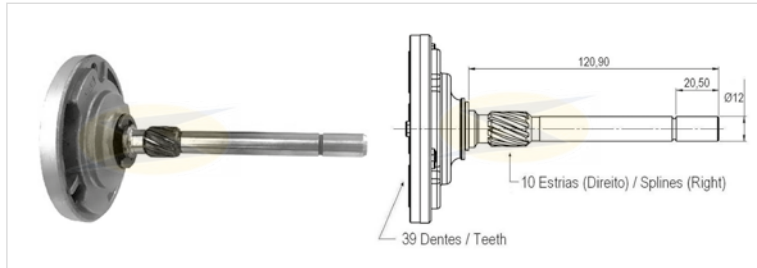

UF-12.149

Tipo / Type: M93R

Original: 352.58.853, K21149, KJD08, KJD09

Partida / Starter: 352.58.880, 352.58.940, 352.58.950, 352.58.990, 352.59.000, 352.59.130, 352.59.210, 352.59.680, 352.59.620, 352.59.630, 352.59.650, 352.59.670, 352.59.690, 352.59.660

Aplicação / Application: **MERCEDES-BENZ:** ÔNIBUS, **CUMMINS:** MOTORES CUMMINS SÉRIE B, **DIMEX:** ÔNIBUS, **FORD:** CAMINHÕES, PICK UP F100

Prestolite

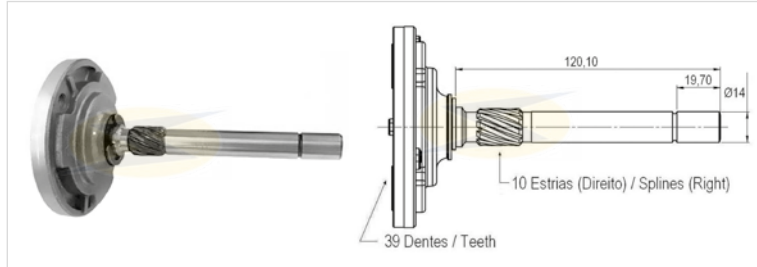

UF-12.212

Tipo / Type: M93R

Original: 352.59.959, (K01212)

Partida / Starter: 352.59.380, 352.59.680

Aplicação / Application: **SHELHURST, MERCEDES-BENZ:** ONIBUS 6CC

Prestolite

UF - 12.219 Tipo / Type: **M93R**

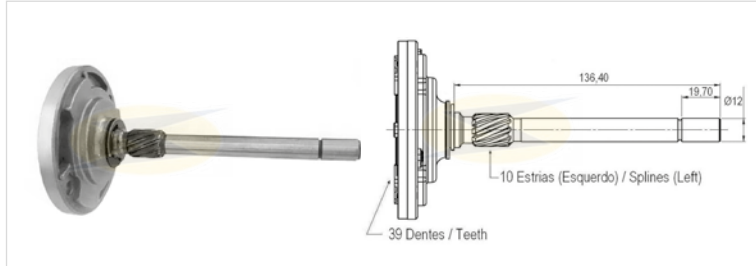

Original: 352.59.859, (K01219)
Partida / Starter: 352.59.480
Aplicação / Application: VOLKSWAGEN: G. IZQ. VW SUDAFRICA

Prestolite

UF - 12.221 Tipo / Type: **M93R**

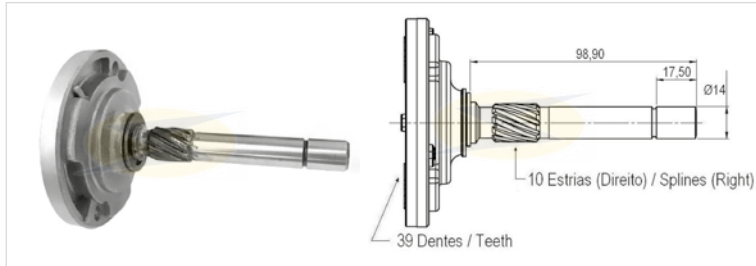

Original: 352.59.952, K01221, K01284
Partida / Starter: 352.59.310, 352.59.710, 352.59.720, 352.61.020, 352.61.175
Aplicação / Application: AGCO: TRATOR 6 CILINDROS PEUGEOT: C/ MOTOR INDENOR, INDE-NOR: MOTORES INDENOR 6.305 / 6.354, FORD: POWER STROKE

Prestolite

UF - 12.222 Tipo / Type: **M93R**

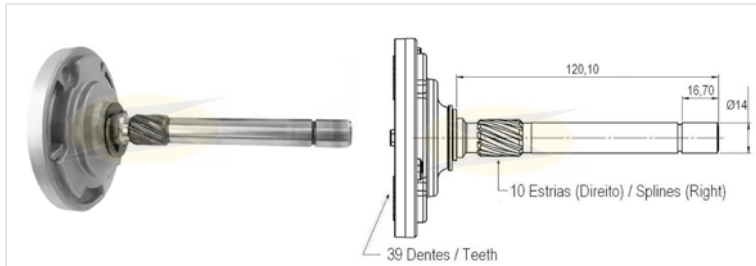

Original: 352.59.465 (K01222, K01261, K01349, K01469, K21148, KJD20, KJD21)
Partida / Starter: 352.59.300, 352.59.430, 352.59.580, 352.59.590, 352.59.600, 352.59.620, 352.59.630, 352.59.650, 352.59.660, 352.59.670, 352.59.690, 352.59.750, 352.59.760, 352.59.880, 352.59.900, 352.60.940, 352.60.950, 352.61.070, 352.61.120, 352.61.155, 352.61.190, 352.61.355, 352.61.360, 352.61.420
Aplicação / Application: DEUTZ AGCO: TRATOR, JOHN DEERE, CUMMINS: MOTORES / VM MOTOR, FORD: F100, PERKINS: D-28 MT, MWM: 4 E 6 CILINDROS, FORD: C/ MOTORES CUMMINS E CUMMINS 4BT, MAXION: MOTOR S4, INTERNACIONAL SOUTH AMERICAN, GRADALL, AGRA-LE: MOTOR MWM, INTERNACIONAL BRAZIL, MASSEY-FERGUSON: TRATOR C/ MOTOR PERKINS

Prestolite

UF - 12.343 Tipo / Type: **M93R**

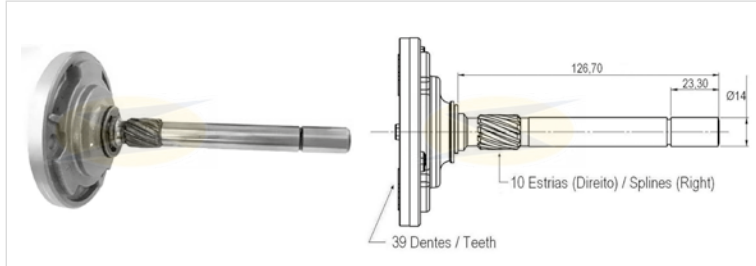

Original: 352.59.915, K01343
Partida / Starter: 352.59.640, 352.59.870
Aplicação / Application: CUMMINS: MOTORES B / 4BT / 6BT / 6BTAA, VOLKSVAGEN: CAMI-NHÕES C/ MOTORES CUMMINS, FORD: CAMINHÕES C/ MOTORES CUMMINS

Valeo

UF-16.101 12V, Tipo/Type: **DSL36100 - 2,2 Kw**

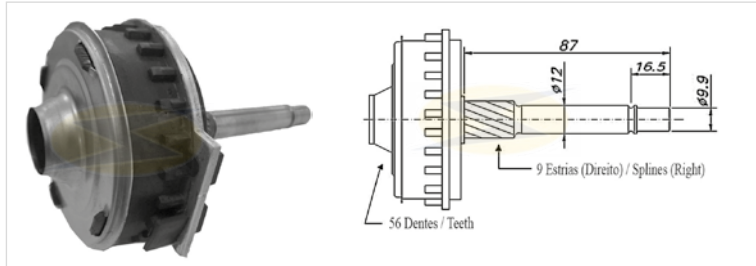

Original:
Partida / Starter: DSL36100, TM00A31201, TM00A36101, 42350
Aplicação / Application: HYUNDAI: H100, HR, ACCENT 1.5 CRDI, KIA: BONGO, CEE'D 1.5, SO-RENTO 2.5 TURBO DIESEL, K2700, MERCEDES-BENZ: SPRINTER, ZEN 1607

Valeo

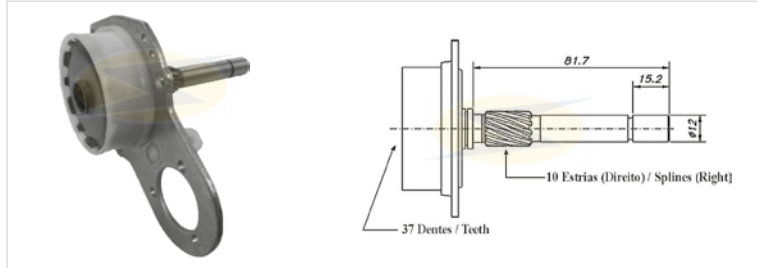

UF-16.102

Tipo/Type: _____

Original: _____

Partida / Starter: D6RA85, D6RA185

Aplicação / Application: CHEVROLET-GM, RENAULT, PEUGEOT, CITROEN, SATURN: SC, SL, SW SERIES (1995→1996) 1.9L (116 CID)

Valeo

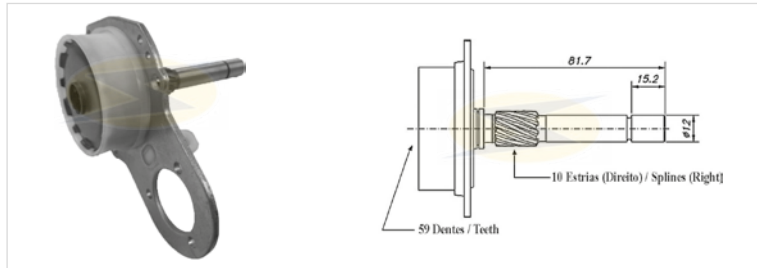

UF-16.103

Tipo/Type: _____

Original: _____

Partida / Starter: D6RA65, D6RA165

Aplicação / Application: CHEVROLET-GM, RENAULT, PEUGEOT, CITROEN, SATURN

Valeo

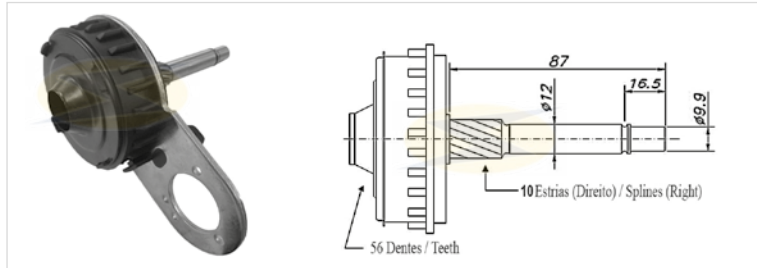

UF-16.104

12V, Tipo/Type: DSL36100 - 2,2 Kw

Original: _____

Partida / Starter: D7R11, D7R12, D7R13, D7R15, D7R151, D7R16, D7R18, D7R19, D7R20, D7R24, D7R25, D7R26, D7R27, D7R28, D7R33, D7R34, D7R35, D7R53

Aplicação / Application: AUDI: A3 (1997→2000) MOTORES CODIGO / ENGINE CODE – ASV, CITROEN: X-SARA, 14 1.4 / 1.5 / 4X4, SAXO 1.5 (1996→2003), ZX 1.4 / 1.5 / 1.9 TD, C.A (1991→1997), 2CV 602 (1970→1990), AX, AMI, ACADIANE, DYANE, MEHARI, BERLINGO 1.8D / 1.9D / 2.0 HDI, FIAT: SCUDO TD, JPY: JIPE MONTEZ, PEUGEOT: 106 1.4 D (1992→1996) / 1.5 D (1994→2005), 206 MOTEUR 1.9D DW8, 405 DIESEL, PARTNER, VOLVO: 400TD, 440 TD, 460 TD, ROVER: AGRUPA 1.4 D (1992→1995), 114D (1992→1994), 115D (1994→1997), TATRA, LANCIA: PHEDRA 2.0 / 2.2 JTD (2002), Z 2.0 JTD

(1999→2000), SUZUKI: GRAND VITARA 1.9L D (2005), SAMURAI 1.9L TD (1998), OPEL: VIVARO 1.9L (2001), NISSAN: MICRA 1.5 D, K11 (1998→2002), PRIMERA 1.9L (2003), MERCEDES-BENZ: SPRINTER, 190D 2.2L D / 2.5L D (1984→1989), 300D, CD, SD, SDL, TD 2.5L D, TD 3.0L D, 3.5L D (1986→1993), 350SD, SDL 3.5L D (1991), E CLASS 3.0L D (1995→1999), S CLASS 3.5L D (1994→1995), SEAT, SKODA: OCTAVIA A4 (2001→2011) MOTORES CODIGO / ENGINE CODES: AQM, AGR, ALH, AHF, ASV, VOLKSWAGEN: BEETLE (1999→2001), BORA (2002→2005), GOLF MK4 (1998→2006), TODOS COM MOTORES CÓDIGO / ALL WITH ENGINE CODES: ASV, AQM, AGR, ALH, AHF, ASV, RENAULT: CLIO EXPRESS, MEGANE EXPRESS, R19 D, R21 D, AVANTIME 2.2 DCI 150CV, ESCAPE III 2.2, LAGUNA / LAGUNA GRANDTOUR 2.2 DT 113CV / II 2.2 DCI 140 / 150CV, SAFRANE II 2.2, VELSATIS 2.2, TRAFIC II 2.5, MASTER 2.2 / 2.5 CDI (2010→), HYUNDAI: HR

Valeo

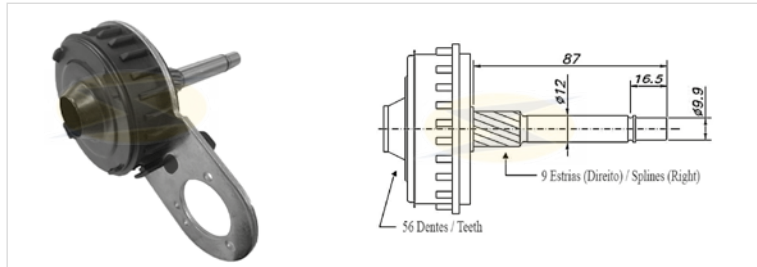

UF-16.105

Tipo/Type: _____

Original: _____

Partida / Starter: D7R11, D7R12, D7R13, D7R15, D7R16, D7R18, D7R19, D7R20, D7R24, D7R25, D7R26, D7R27, D7R28, D7R33, D7R34, D7R35, D7R43, D7R53, D7GR53

Aplicação / Application: RENAULT: CLIO EXPRESS, MEGANE EXPRESS, R19 D, R21 D, AVANTIME 2.2 DCI 150CV, ESCAPE III 2.2, LAGUNA / LAGUNA GRANDTOUR 2.2 DT 113CV II 2.2 DCI 140 / 150CV, SAFRANE II 2.2, VELSATIS 2.2, TRAFIC II 2.5, MASTER 2.2 / 2.5 CDI (2010→), HYUNDAI: HR, MITSUBISHI: KATANA, L200

Bosch **R - 0055** Original: _____

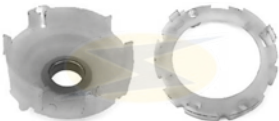

Motor de Partida / Starter: 0 001 107 037, 0 001 107 048, 0 001 108 157, 0 001 108 169

Aplicação / Application: MERCEDES-BENZ, BMW.

APLICAÇÃO / Application: UF-11.058 / UF-11.145 / UF-11.181

Bosch **R - 0057** Original: 1 005 821 307



37 dentes / teeth

Motor de Partida / Starter: 0 001 108 013, 0 001 108 021, 0 001 108 022, 0 001 108 023, 0 001 108 026, 0 001 108 027, 0 001 108 030, 0 001 108 031, 0 001 108 032, 0 001 108 035, 0 001 108 037, 0 001 108 038, 0 001 108 040, 0 001 108 045, 0 001 108 046, 0 001 108 048, 0 001 108 051, 0 001 108 052, 0 001 108 053, 0 001 108 056, 0 001 108 061, 0 001 108 066, 0 001 108 068, 0 001 108 069, 0 001 108 070, 0 001 108 072, 0 001 108 073, 0 001 108 076, 0 001 108 077, 0 001 108 081, 0 001 108 084, 0 001 108 091, 0 001 108 092, 0 001 108 093, 0 001 108 094, 0 001 108 095, 0 001 108 103, 0 001 108 104, 0 001 108 105, 0 001 108 135, 0 001 108 137, 0 001 108 144, 0 001 108 151, 0 001 108 154, 0 001 108 159, 0 001 109 040

Aplicação / Application: ALFA, AUDI, CHRYSLER, FIAT, JEEP, LAND ROVER, VOLKSWAGEN

APLICAÇÃO / Application: UF-11.307

Bosch **R - 0060** Original: 2 337 1F4 029



36 dentes / teeth

Motor de Partida / Starter: 9 008 046 015

Aplicação / Application: NISSAN

APLICAÇÃO / Application: UF-11.029

Bosch **R - 0062** Original: 1 006 200 104



Motor de Partida / Starter: 0 001 107 048, 0 001 108 064, 0 001 108 080, 0 001 108 088, 0 001 108 101, 0 001 108 102, 0 001 108 113, 0 001 108 121, 0 001 108 143

Aplicação / Application: MERCEDES-BENZ, BMW, CHEVROLET-GM, OPEL, VOLVO, AUDI, FIAT, FORD, RENAULT

APLICAÇÃO / Application: UF-11.104

Bosch **R - 0076** Original: 1 006 200 099, 1 006 200 143, (2.2367.0)



38 dentes / teeth

Motor de Partida / Starter: 0 001 109 014, 0 001 109 018, 0 001 109 026, 0 001 109 036, 0 001 109 048, 0 001 109 300, 0 001 110 012, F 000 AL1 401, 0 001 123 001, 0 001 124 015, 0 001 125 025, 0 986 022 470

Aplicação / Application: CITROEN: RELAY 2.8, FIAT: DUCATO 2.3 / 2.8, ULYSSE 1.9 TD / 2.1TD (1995→1998), STRADA 1.9D (2000→), STRADA 1.7 TDS (1999→), PUNTO 1.7 D / TD (1995→1999), MB: 410D SPRINTER (1997→2000), 312D SPRINTER (1995→2000), NISSAN: FRONTIER, PEUGEOT: BOXER 2.8, PORSCHE: BOXSTER (1996→2004) 2.5 / 2.7 / 3.2, 911 CARRERA / CARRERA 3.6, 912, 996, 997, GT3, CAYENNE (2002)

APLICAÇÃO / Application: UF-11.099, UF-11.111, UF-11.218, UF-11.220, UF-11.122, UF-11.143

Bosch **R - 0056** Original: 1 006 200 110, 1 006 200 123, 1 006 200 128, F 000 AL1 015, F 000 AL1 017, F 000 AL1 019



37 dentes / teeth

Motor de Partida / Starter: 0 001 107 007, 0 001 107 009, 0 001 107 015, 0 001 107 020, 0 001 108 026, 0 001 108 048, 0 001 108 136, 0 001 108 146, 0 001 108 154, 0 001 108 159, 0 001 109 040, 9 000 081 001, 9 000 081 005, 9 000 081 006, 9 000 081 007, 9 000 081 008, F 000 AL0100, F 005 M00 012, F 005 M00 014

Aplicação / Application: PARA MOTORES PARTIDA BOSCH - DW, **APLICAÇÃO / Application:** UF-11.010 / 11.015 / 11.018 / 11.019 / 11.037 / 11.128 / 11.181

Bosch **R - 0058** Original: 1 006 200 161



36 dentes / teeth

Motor de Partida / Starter: 0 001 106 012, 0 001 106 017, 0 001 106 022, 0 001 106 023, 0 001 107 056, 0 001 107 100, 0 001 107 101, 0 001 107 108

Aplicação / Application: ALFA ROMEO, AUDI, CI-TRUEN, LANCIA, MB: CLASSE A, OPEL, PEUGEOT, RENAULT, SEAT, VAUSHALL, VOLKSWAGEN,

APLICAÇÃO / Application: UF-11.161 / UF-11.123 / UF-11.153

Bosch **R - 0061** Original: 1 006 200 059 (1 006 200 098)

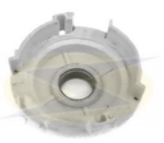

Motor de Partida / Starter: 0 001 107 403, 0 001 108 123, 0 001 108 124, 0 001 108 134, 0 001 108 160, 0 001 108 995

Aplicação / Application: MERCEDES-BENZ, CHRYSLER, **APLICAÇÃO / Application:** UF-11.059

Bosch **R - 0075** Original: 1 006 200 099, F 000 AL1 974, 1 006 200 218, 1 006 200 220, 1 006 200 122, (2.235.0), 1 006 200 143, (2.2367.0)



Motor de Partida / Starter: 0 001 109 014, 0 001 109 018, 0 001 109 026, 0 001 109 036, 0 001 109 048, 0 001 109 300, 0 001 110 012, F 000 AL1 401, F 000 AL0 111, 0 001 109 300, 0 001 109 301, F 004 A94 008, F 004 A94 011, 0 001 125 042, 0 001 123 001, 0 001 124 015, 0 001 125 025, 0 986 022 470

Aplicação / Application: CITROEN: RELAY 2.8, JUMPER 2.8 HDI, JUMPER 2.8 4X4, FIAT: DUCATO 2.3 / 2.8, ULYSSE 1.9 TD / 2.1TD (1995→1998), STRADA 1.9D (2000→), STRADA 1.7 TDS (1999→), PUNTO 1.7 D / TD (1995→1999), DUCATO 2.3 JTD, DUCATO 2.8 DIESEL, DUCATO 2.8 DIESEL 4X4, DUCATO 2.8 JTD, DUCATO 2.8 JTD 4X4, MB: 410D SPRINTER (1997→2000), 312D SPRINTER (1995→2000), NISSAN: FRONTIER, PEUGEOT: BOXER 2.8, BOXER 2.8 HDI, BOXER 2.8 HDI 4X4, TOYOTA: HILUX / SW4 D4D 2.5 / 2.8 / 3.0 DIESEL (2006→), HILUX D4D, SW4 D4D, YARIS D4D, YARIS VERSO D4D, COROLLA D4D, COROLLA VERSO D4D, AVENSIS D4D, AVENSIS VERSO D4D, RAV4 D4D, LANDCRUISER D4D, PREVIA D4D, SEAT: ALHAMBRA / CORDOBA 1.9 TDI (1997→2001), VOLKSWAGEN: GOLF 1.9 TDI (1997→2001), PORSCHE: BOXSTER (1996→2004) 2.5 / 2.7 / 3.2, 911 CARRERA / CARRERA 3.6, 912, 996, 997, GT3, CAYENNE (2002).

APLICAÇÃO / Application: UF-11.099, UF-11.111, UF-11.218, UF-11.220, UF-11.122, UF-11.143

Bosch

R - 0077

Original: 1 006 200 218

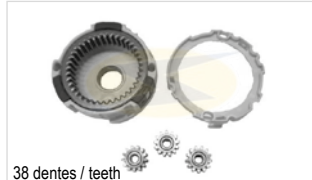

38 dentes / teeth

Motor de Partida / Starter: 0 001 109 300, 0 001 109 301
Aplicação / Application: CITROEN: JUMPER 2.8 HDI, JUMPER 2.8 4x4, FIAT: DUCATO 2.3 JTD, DUCATO 2.8 DIESEL, DUCATO 2.8 DIESEL 4x4, DUCATO 2.8 JTD, DUCATO 2.8 JTD 4x4, PEUGEOT: BOXER 2.8 HDI, BOXER 2.8 HDI 4X4
APLICAÇÃO / Application: UF-11.099, UF-11.111, UF-

11.218, UF-11.220, UF-11.122, UF-11.143

Bosch

R - 0078

Original: 1 006 200 220,

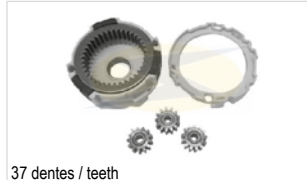

37 dentes / teeth

F 000 AL1 974
Motor de Partida / Starter: F 004 A94 008, F 004 A94 011, F 000 AL0 111
Aplicação / Application: TOYOTA: HILLUX D4D, SW4 D4D, HILUX / SW4 D4D 2.5 / 2.8 / 3.0 DIESEL (2006→), YARIS D4D, YARIS VERSO D4D, COROLLA D4D, CO-

ROLA VERSO D4D, AVENSIS D4D, AVENSIS VERSO D4D, RAV4 D4D, LAND CRUISER D4D, PREVIA D4D **APLICAÇÃO / Application:** UF-11.111, UF-11.220

Bosch

R - 0079

Original: 1 006 200 117, (2.2363.0),



1 006 200 118, (2.2364.0), 1 006 200 126, (2.2366.0)
Motor de Partida / Starter: 0 001 125 001, 0 001 125 002, 0 001 125 005, 0 001 125 006, 0 001 125 007, 0 001125 008, 0 001 125 009, 0 001 125 010, 0 001 125 012, 0 001 125 013, 0 001 125 021, 0 001 125 022, 0 001 125 031, 0 001 125 032, 0 001 125 035, 0 001 125 036, 0 001 125 042, 0 001 125 043,

0 001 125 051, 0 001 125 052, 0 001 124 011, 0 001 124 012, 0 001 125 039, 0 001 125 040, 0 001 125 501, 0 001 125 502

Aplicação / Application: AUDI: A2 / A3 / S3 1.9 TDI, SEAT: AROSC 1.7SDI, LUPO 1.7 SDI, POLO 1.7 / 1.9D SDI, LT 2.5 TD (1999→), LT 2.5 TD 4X4 (1985→2001), ALHAMBRA, CORDOBA, IBIZA II, LEON, TOLEDO 1.7D / 1.9D / TD / TDI / SDI / V5, VOLKSWAGEN: BORA, CANDYII, CABRIO, CORRADO, EUROVAN, GOLF, JETTA, NEW BEETLE, PASSAT, POLO, SHARAN MOTORES 1.4 / 1.5D / 1.6D / 1.8GTI / 1.9 SDI / TDI / V5 / V6 / 2.8 VR6 / 2.9 VR6, TRANSPORTER 1.2 / 1.5 / 1.6 / 1.9TD / 2.4D, 2.5 / 2.5 SYNCRO / TDI / 2.8 VR6, VENTO 1.9D / SDI / TD / TDI / VR6, SKODA: FABIA, OCTAVIA 1.4TDI / 1.9 SDI / TDI, TDI, FORD: GALAXY 1.9 / 2.0 / 2.3 / 2.8 TDI / VR6, MB: V280.

APLICAÇÃO / Application: UF-11.117, UF-11.118, UF-11.126

Bosch

R - 0080

Original: 1 006 200 110, 1 006

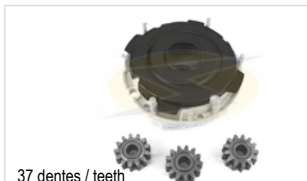

37 dentes / teeth

200 123, 1 006 200 128, F 000 AL1 015, F 000 AL1 017, F 000 AL1 019

Motor de Partida / Starter: 0 001 107 007, 0 001 107 009, 0 001 107 015, 0 001 107 020, 0 001 108 026, 0 001 108 048, 0 001 108 136, 0 001 108 146, 0 001 108 154, 0 001 108 159, 0 001109 040, 9 000 081 001, 9 000 081 005, 9

000 081 006, 9 000 081 007, 9 000 081 008, F 000 AL0 100, F 005 M00 012, F 005 M00 014

Aplicação / Application: PARA MOTORES PARTIDA BOSCH - DW

APLICAÇÃO / Application: UF-11.010 / 11.015 / 11.018 / 11.019 / 11.037 / 11.128 / 11.181

Bosch

R - 0083

Original: 1 006 200 161



36 dentes / teeth

Motor de Partida / Starter: 0 001 106 012, 0 001 106 017, 0 001 106 022, 0 001 106 023, 0 001 107 056, 0 001 107 100, 0 001 107 101, 0 001 107 108

Aplicação / Application: ALFA ROMEO, AUDI, CITROEN, LANCIA, OPEL, PEUGEOT, RE-NAULT, SEAT, VAUSHALL, VOLKSWAGEN

APLICAÇÃO / Application: UF-11.161 / UF-11.123 / UF-11.153

Bosch

R - 0081

Original: 1 005 821 307



37 dentes / teeth

Motor de Partida / Starter: 0 001 107 003, 0 001 108 013, 0 001 108 021, 0 001 108 022, 0 001 108 023, 0 001 108 026, 0 001 108 027, 0 001 108 030, 0 001 108 031, 0 001 108 032, 0 001 108 035, 0 001 108 037, 0 001 108 038, 0 001 108 040, 0 001 108 045, 0 001 108 046, 051, 0 001 108 052, 0 001 108 053, 0 001 108 056, 0 001 108 061, 0 001 108 066, 0 001 108

068, 0 001 108 069, 0 001 108 070, 0 001 108 072, 0 001 108 073, 0 001 108 076, 0 001 108 077, 0 001 108 081, 0 001 108 084, 0 001 108 091, 0 001 108 092, 0 001 108 093, 0 001 108 094, 0 001 108 095, 0 001 108 103, 0 001 108 104, 0 001 108 105, 0 001 108 135, 0 001 108 137, 0 001 108 144, 0 001 108 151, 0 001 108 154, 0 001 108 159, 0 001 109 040

Aplicação / Application: ALFA, AUDI, CHRYSLER, FIAT, JEEP, ROVER, VOLKSWAGEN

APLICAÇÃO / Application: UF-11.307

Bosch

R - 0085

Original: 2 337 1F4 029

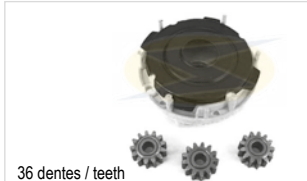

36 dentes / teeth

Motor de Partida / Starter: 9 008 046 015

Aplicação / Application: NISSAN

APLICAÇÃO / Application: UF-11.029

Bosch

R - 0086

Original: 1 006 200 059

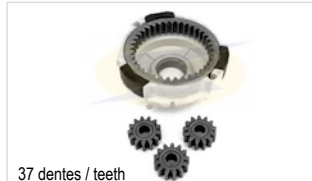

37 dentes / teeth

(1 006 200 098)
Motor de Partida / Starter: 0 001 107 403, 0 001 108 123, 0 001 108 124, 0 001 108 134, 0 001 108 160, 0 001 108 995

Aplicação / Application: MERCEDES-BENZ: C 180/ T-MODELL / 200 / 220 / 230, CLK 230 K.P, E 230, ML 230

SLK 230 K.R, 124-200E, CHRYSLER: DODGE DAKOTA 2.5 D, GRAND CARAVAN 2.5, VOYAGER 2.5 / 3.3 / 3.6

APLICAÇÃO / Application: UF-11.059

Bosch

R - 0087

Original: 1 006 200 104

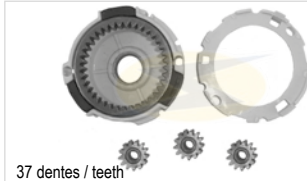

37 dentes / teeth

Motor de Partida / Starter: 0 001 107 048, 0 001 108 064, 0 001 108 080, 0 001 108 088, 0 001 108 101, 0 001 108 102, 0 001 108 113, 0 001 108 121, 0 001 108 143

Aplicação / Application: MERCEDES-BENZ, BMW, CHEVROLET-GM, OPEL, VOLVO, AUDI, FIAT, FORD, RENAULT

APLICAÇÃO / Application: UF-11.104

Bosch **R - 0090** Original: _____

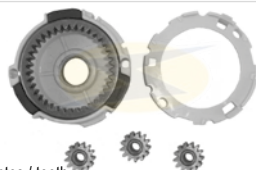

36 dentes / teeth

Motor de Partida / Starter: 0 001 107 037, 0 001 107 048, 0 001 108 157, 0 001 108 169

Aplicação / Application: MERCEDES-BENZ, BMW

APLICAÇÃO / Application: UF-11.145

Bosch **R - 0094** Original: _____

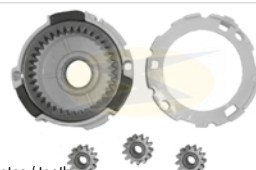

37 dentes / teeth

Motor de Partida / Starter: 0 001 107 045

Aplicação / Application: OPEL: CALIBRA 2.0I 16V (09/1993→08/96), ASTRA 2.0I (01/1995→02/1998), CHEVROLET-GM: ASTRA, ASTRA SEDAN 2.0I 16V (02/1999→07/2001), VECTRA 2.0 16V (04/1996→11/1997), ZAFIRA 2.0 SFI 16V (04/2001→) **APLICAÇÃO / Application:** UF-11.058

Bosch **R - 0105** Original: 1 006 200 122, (2.235.0)



42 dentes / teeth

Motor de Partida / Starter: 0 001 125 042

Aplicação / Application: SEAT: ALHAMBRA, CORDOBA 1.9 TDI (1997→2001), VOLKSWAGEN: GOLF 1.9 TDI (1997→2001)

APLICAÇÃO / Application: UF-11.122

Bosch **R - 0106** Original: 6 033 AD0 053, 033

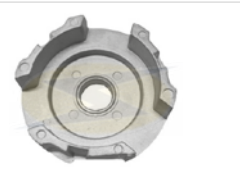

AC0 252, 6 033 AD0 090, 6 033 AD0 108

Motor de Partida / Starter: 001 223 001, 0 001 223 009, 0 001 223 010, 0 001 223 013, 0 001 223 505

Aplicação / Application: FIAT: DUCATO 10 2.8 TD / TD EGR (1997→2002), FORD: F-250 6CC MWM 6.07 TCA (1999→), F-250 4CC CUMMINS 4BTAA (1998→), F-400, IVECO: DAILY 12 8140 (1997→), PEUGEOT: JUMPER

APLICAÇÃO / Application: UF-11.003, UF-11.090

Bosch **R - 0107** Original: 6 033 AD0 053, 033



40 dentes / teeth

AC0 252, 6 033 AD0 090, 6 033 AD0 108

Motor de Partida / Starter: 001 223 001, 0 001 223 009, 0 001 223 010, 0 001 223 013, 0 001 223 505

Aplicação / Application: FIAT: DUCATO 10 2.8 TD / TD EGR (1997→2002), FORD: F-250 6CC MWM 6.07 TCA (1999→), F-250 4CC CUMMINS 4BTAA (1998→), F-400, IVECO: DAILY 12 8140 (1997→), PEUGEOT: JUMPER

APLICAÇÃO / Application: UF-11.003, UF-11.090

Bosch **R - 0108** Original: 1 006 200 117, (2.2363.0), 1 006 200 118, (2.2364.0), 1 006 200 126, (2.2366.0)

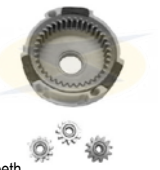

38 dentes / teeth

Motor de Partida / Starter: 0 001 125 001, 0 001 125 002, 0 001 125 005, 0 001 125 006, 0 001 125 007, 0 001125 008, 0 001 125 009, 0 001 125 010, 0 001 125 012, 0 001 125 013, 0 001 125 021, 0 001 125 022, 0 001 125 031, 0 001 125 032, 0 001 125 035, 0 001 125 036, 0 001 125 042, 0 001 125 043, 0 001 125 051, 0 001 125 052, 0 001 124 011, 0 001 124 012, 0 001 125 039, 0 001 125 040, 0 001 125 501, 0 001 125 502

Aplicação / Application: AUDI: A2 / A3 / S3 1.9 TDI, SEAT: AROSC 1.7SDI, LUPO 1.7 SDI, POLO 1.7 / 1.9D / 1.9D / TD / TDI / SDI / V5, VOLKSWAGEN: BORA, CANDYII, CABRIO, CORRADO, EUROVAN, GOLF, JETTA, NEW BEETLE, PASSAT, POLO, SHARAN MOTORES 1.4 / 1.5D / 1.6D / 1.8GTI / 1.9 SDI / TDI / V5 / V6 / 2.8 VR6 / 2.9 VR6, TRANSPORTER 1.2 / 1.5 / 1.6 / 1.9TD / 2.4D, 2.5 / 2.5 SYNCRO / TDI / 2.8 VR6, VENTO 1.9D / SDI / TD / TDI / VR6, SKODA: FABIA, OCTAVIA 1.4TDI / 1.9 SDI / TDI, TDI, FORD: GALAXY 1.9 / 2.0 / 2.3 / 2.8 TDI / VR6, MB: V280.

APLICAÇÃO / Application: UF-11.117, UF-11.118, UF-11.126

Bosch

R - 0109

Original: 9 001 337 067, (9 001 336 285), 9 001 337 073, 9 001 337 059, 9 001 337 056, (9 003 336 268)

Motor de Partida / Starter: 9 000 331 406, 0 001 218 116, 0 001 218 117, 0 001 218 011, 0 001 218 122, 0 001 218 159, 0 001 218 168, 0 001 218 171, 0 001 218 174, 0 001 218 177, 9 000 331 432, 9 000 331 433, 0 001 218 108, 0 001 218 137, 0

001 218 165, 0 001 218 722, 9 000 331 419

Aplicação / Application: **CHEVROLET-GM:** BLAZER 2.5 DIESEL (MOTOR 4A) (08/1997→), ASTRA, BLAZER, S10, VECTRA - II(SOHC) 1.8 / 2.0 / 2.2- 8V (→03/2001), **OPEL:** FRONTERA 2.3 TD (MOTOR 23 DTR TURBO), OMEGA 2.3 TD (MOTOR 23 DTR) (09/1988→03/1994) , (MOTOR 23YDT) (09/1986→08/1988), **FIAT:** DUCATO 10 2.5 D (MOTOR 8140.67) (03/1994→03/1998) E TD EGR (MOTOR 8140.47) (03/1994→03/1998), **MBB:** CLASSE S600 SEC V12 / S 600 (MOTOR 120-982) (09/1996→08/1999), 600 SEL (MOTOR 120.980) (04/1991→05/1993), S600 (MOTOR 120.980) (06/1993→09/1995), SÉRIE MB 100D (MOTOR OM 616.963) (09/91→01/1996), MB 180D (MOTOR 616) (04/1994→), 310D SPRINTER (MOTOR OM014A) (1996→), 312D (MOTOR OM014LA) (08/1999→), 412D (MOTOR OM014LA) (10/1999→), **LAND ROVER:** DEFENDER 2.5 TURBO DIESEL (MOTOR GEMINITCIDI 23L) (08/1990→12/2001), (MOTOR MAXION HS4TCC) (08/1998→), DISCOVERY 2.5 TDI (MOTOR 12L / 21L) (09/1989→09/1994), (MOTOR 19L) (10/1993→12/1998), RANGE ROVER I 2.5 TDI CLASSIC (MOTOR 14L) (10/1992→09/1994), (MOTOR 300 TDI (10/1994→04/9196), RANGE ROVER II 2.5 DT /DSE (MOTOR M51-D25) (09/1994→09/2002), **IVECO:** DAILY 10 (MOTOR 8140) (11/1997→), **DODGE:** DAKOTA 2.5D (MOTOR MAGNUM 2.5 L-4) (10/1998→), **FORD:** F-1000 (10/1995→), F-1000 HSD (10/1995→), **RENAULT:** JUMPER, **SSANGYONG:** MUSSO 2.9 DIESEL (MOTOR OM 662 D29) (07/1993→), **VOLKSWAGEN:** TRANSPORTER 2.4D, SYNCRO (1990→1994)

APLICAÇÃO / Application: UF-11.056, UF-11.067, UF-11.073, UF-11.590

Bosh

R - 0112

Tipo / Type: EV 12V - 2,20 KW

Motor de Partida / Starter: 0 001 218 108, 0 001 218 137, 0 001 218 165, 0 001 218 722, 9 000 331 419

Aplicação / Application: **MBB:** MBB: Classe S600 sec v12 / s 600 (motor 120-982) (09/1996→08/1999), 600 sel (motor 120.980) (04/1991→05/1993), S600 (motor 120.980) (06/1993→09/1995). Série, MB 100d (motor OM 616.963)

(09/1991→01/1996), MB 180d (motor 616) (04/1994→), **SSANGYONG:**Musso 2.9 Diesel (motor OM 662 D29)

(07/1993→) **APLICAÇÃO / Application:** UF - 11.056

Delco

R - 0063

Original: 9 000 981

Motor de Partida / Starter: 9000846, 9000794

Aplicação / Application: **CHEVROLET-GM:** ASTRA, BLAZER, S10, VECTRA - II (SOHC) 1.8 / 2.0 / 2.2 - 8V (→2003)

APLICAÇÃO / Application: UF-14.150

50 dentes / teeth

Delco

R - 0065

Original: 10476598

Motor de Partida / Starter: 9 000 786, 9 000 798, 9 000 804, 9 000 805, 9 000 806, 9 000 812, 9 000 819, 9 000 820, 9 000 821, 9 000 822, 9 000 827, 9 000 834, 9 000 835, 9 000 844, 9 000 850, 9 000 851, 9 000 853, 9 000 860, 9 000 861, 9 000 862, 9 000 863, 9 000 864, 9 000 866, 9 000 867, 9 000 899, 9 000 900, 10476598

Aplicação / Application: **CHEVROLET-GM:** BLAZER / S10 4.3 V6, **CLARK:** EMPILHADEIRA / **FORKLIFT** / CGP25 **APLICAÇÃO / Application:** UF-14.910

Bosch

R - 0110

Original: 9 001 337 067, (9 001 336 285), 9 001 337 073, 9 001 337 059, 9 001 337 056, (9 003 336 268)

Motor de Partida / Starter: 9 000 331 406, 0 001 218 116, 0 001 218 117, 0 001 218 011, 0 001 218 122, 0 001 218 159, 0 001 218 168, 0 001 218 171, 0 001 218 174, 0 001 218 177, 9 000 331 432, 9 000 331 433, 0 001 218 108, 0

001 218 137, 0 001 218 165, 0 001 218 722, 9 000 331 419

Aplicação / Application: **CHEVROLET-GM:** BLAZER 2.5 DIESEL (MOTOR 4A) (08/1997→), ASTRA, BLAZER, S10, VECTRA - II(SOHC) 1.8 / 2.0 / 2.2- 8V (→03/2001), **OPEL:** FRONTERA 2.3 TD (MOTOR 23 DTR TURBO), OMEGA 2.3 TD (MOTOR 23 DTR) (09/1988→03/1994) , (MOTOR 23YDT) (09/1986→08/1988), **FIAT:** DUCATO 10 2.5 D (MOTOR 8140.67) (03/1994→03/1998) E TD EGR (MOTOR 8140.47) (03/1994→03/1998), **MBB:** CLASSE S600 SEC V12 / S 600 (MOTOR 120-982) (09/1996→08/1999), 600 SEL (MOTOR 120.980) (04/1991→05/1993), S600 (MOTOR 120.980) (06/1993→09/1995), SÉRIE MB 100D (MOTOR OM 616.963) (09/91→01/1996), MB 180D (MOTOR 616) (04/1994→), 310D SPRINTER (MOTOR OM014A) (1996→), 312D (MOTOR OM014LA) (08/1999→), 412D (MOTOR OM014LA) (10/1999→), **LAND ROVER:** DEFENDER 2.5 TURBO DIESEL (MOTOR GEMINITCIDI 23L) (08/1990→12/2001), (MOTOR MAXION HS4TCC) (08/1998→), DISCOVERY 2.5 TDI (MOTOR 12L / 21L) (09/1989→09/1994), (MOTOR 19L) (10/1993→12/1998), RANGE ROVER I 2.5 TDI CLASSIC (MOTOR 14L) (10/1992→09/1994), (MOTOR 300 TDI (10/1994→04/9196), RANGE ROVER II 2.5 DT /DSE (MOTOR M51-D25) (09/1994→09/2002), **IVECO:** DAILY 10 (MOTOR 8140) (11/1997→), **DODGE:** DAKOTA 2.5D (MOTOR MAGNUM 2.5 L-4) (10/1998→), **FORD:** F-1000 (10/1995→), F-1000 HSD (10/1995→), **RENAULT:** JUMPER, **SSANGYONG:** MUSSO 2.9 DIESEL (MOTOR OM 662 D29) (07/1993→), **VOLKSWAGEN:** TRANSPORTER 2.4D, SYNCRO (1990→1994)

APLICAÇÃO / Application: UF-11.067, UF-11.073, UF-11.590

Delco

R - 0064

Original:

Motor de Partida / Starter: 9000981, 9000890, 9000891, 9000893, (PG260B), (PG260C), (PG260D)

Aplicação / Application: **CHEVROLET-GM:** AGILE, ASTRA, BLAZER, CELTA, COBALT 1.0 / 1.4 / 1.6, CORSA / PICKUP, NOVO CORSA, CORSA CLASSIC, MONTANA, PRISMA, S10, VECTRA - II(SOHC) 1.8 / 2.0 / 2.2 8V

50 dentes / teeth

(03/2001→) / II(DOHC) 2.0 / 2.2 16V

APLICAÇÃO / Application: UF-14.368

Delco

R - 0071

Original: 10450720

Motor de Partida / Starter:

Aplicação / Application: **CHEVROLET-GM:** BLAZER, S-10 C/ MOTOR VORTEC V6 4.3

REPARO DA PLANETÁRIA UF-14.890

43 dentes / teeth

Delco **R - 0088** Original: 9 000 981

Motor de Partida / Starter: 9000846, 9000794

Aplicação / Application: CHEVROLET-GM: ASTRA, BLAZER, S10, VECTRA - TODOS C/ MOTOR II (SOHC) 1.8 / 2.0 / 2.2 8V (→03/2001)

APLICAÇÃO / Application: UF-14.150



50 dentes / teeth

Delco **R - 0089** Original: _____

Motor de Partida / Starter: 9000890, 9000891, 9000893, 9000981, (PG260B), (PG260C), (PG260D)

Aplicação / Application: CHEVROLET-GM: AGILE, ASTRA, BLAZER, CELTA, COBALT 1.0 / 1.4 / 1.6, CORSA / PICKUP, NOVO CORSA, CORSA CLASSIC, MONTANA, PRISMA, S10, VECTRA - II(SOHC) 1.8 / 2.0 / 2.2 8V (03/2001→) / II(DOHC)

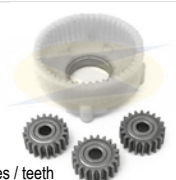

50 dentes / teeth

2.0 / 2.2 16V
APLICAÇÃO / Application: UF-14.368

Delco **R - 0091** Original: 10476598

Motor de Partida / Starter: 9 000 786, 9 000 798, 9 000 804, 9 000 805, 9 000 806, 9 000 812, 9 000 819, 9 000 820, 9 000 827, 9 000 834, 9 000 835, 9 000 844, 9 000 850, 9 000 851, 9 000 853, 9 000 860, 9 000 861, 9 000 862, 9 000 863, 9 000 864, 9 000 866, 9 000 867, 9 000 899, 9 000 900, 9 000 910

Aplicação / Application: CHEVROLET-GM: BLAZER, S10 4.3 V6, CLARK: EMPILHADEIRA / FORKLIFT C/ CGP25. **APLICAÇÃO / Application:** UF-14.910



48 dentes / teeth

Delco **R - 0097** Original: 10450720

Motor de Partida / Starter: 8000034, 9000973

Aplicação / Application: CHEVROLET-GM: BLAZER, S-10 c/ MOTOR VORTEC V6 4.3

APLICAÇÃO / Application: UF-14.890



43 dentes / teeth

Aplicação / Application: CHEVROLET-GM: BLAZER, S10 4.3 V6, CLARK: EMPILHADEIRA / FORKLIFT C/ CGP25. **APLICAÇÃO / Application:** UF-14.910

Ford / Motorcraft **R - 0059** Original: _____

Motor de Partida / Starter: 96BB 11000-AA 7.119 BI

Aplicação / Application: FORD: ESCORT, FIESTA, KA, MONDEO

APLICAÇÃO / Application: UF-13.119



45 dentes / teeth

Ford / Motorcraft **R - 0067** Original: _____

Motor de Partida / Starter: F8TU-11.000 DD 9251-AI

Aplicação / Application: FORD: RANGER, ECOESPORT, BRONCO

APLICAÇÃO / Application: UF-13.120 / 13.121 / 13.122



37 dentes / teeth

Ford / Motorcraft **R - 0074** Original: _____

Motor de Partida / Starter: 96BB 11000 AA 7.119 BI

Aplicação / Application: FORD: ESCORT, FIESTA, KA

APLICAÇÃO / Application: UF-13.119



45 dentes / teeth

Ford / Motorcraft **R - 0084** Original: _____

Motor de Partida / Starter: 96BB 11000-AA 7.119 BI

Aplicação / Application: FORD: ESCORT, FIESTA, KA

APLICAÇÃO / Application: UF-13.119



45 dentes / teeth

Ford / Motorcraft **R - 0092** Original: c/ 4 engrenagens

Motor de Partida / Starter: F8TU-11.000 DD 9251-AI

Aplicação / Application: FORD: RANGER, ECOE-PORT

APLICAÇÃO / Application: UF-13.120



37 dentes / teeth

Ford / Motorcraft **R - 0093** Original: c/ 3 engrenagens

Motor de Partida / Starter: F07UAA716A, F2TUA7C27A

Aplicação / Application: FORD: RANGER 4.0 GAS., EXPLOER 4.0, F-1000 (GAS.), F-4000 4.9 L

APLICAÇÃO / Application: UF-13.121 / 13.122



37 dentes / teeth

Mitsubishi / Delco **R - 0066** Original: _____

Motor de Partida / Starter: CGP 25

Aplicação / Application: CHEVROLET-GM: OMEGA / SUPREMA GLS 95-98, CD 6CC 4.1 MPFI, CLARK: EMPILHAD. / FORKLIFT, HYUNDAI: SONATA, MITSUBISHI: EMPILHAD./ FORKLIFT, PAJERO V6 GAS.

APLICAÇÃO / Application: UF-15.101 / UF-14.711

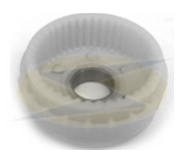

43 dentes / teeth

Mitsubishi **R - 0070** Original: M135X01571

Motor de Partida / Starter: MOT0081, 80381, 80881, 80981, 81081

Aplicação / Application: MAZDA: FP13-18-X56 - MXS MIATA, PROTEGE, MPV, CHEVROLET-GM: S-10, VOLARE: MICRO ÔNIBUS, NISSAN

APLICAÇÃO / Application: UF-15.100



42 dentes / teeth

Mitsubishi

R - 0072

Original: _____

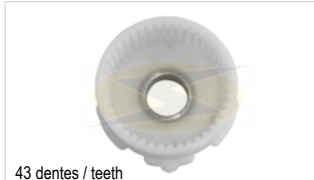

43 dentes / teeth

Motor de Partida / Starter: MANDO, MITSUBISHI PMGR

Aplicação / Application: AMC (1985→2000), CHEVROLET-GM, CHRYSLER, DODGE, EAGLE, FORD, GEO, HYUNDAI, INFINITI, JEEP, MAZDA, MERCURY, MITSUBISHI, NISSAN, PLYMOUTH, SUBARU, SUZUKI, CATERPILLAR,

CLARK

Mitsubishi

R - 0073

Original: _____

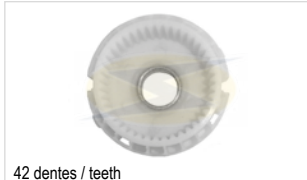

42 dentes / teeth

Motor de Partida / Starter: _____

Aplicação / Application: HYSTER:EMPILHADEIRA / FORKLIFT, RENAULT

APLICAÇÃO / Application: UF-15.104

Mitsubishi

R - 0096

Original: M135X01571



42 dentes / teeth

Motor de Partida / Starter: M0T0081, 80381, 80881, 80981, 81081

Aplicação / Application: MAZDA: FP13-18-X56 - MX5 MIATA, PROTEGE, MPV, CHEVROLET-GM: S-10, VOLARE: MICRO ÔNIBUS, NISSAN

APLICAÇÃO / Application: UF-15.100

Mitsubishi

R - 0098

Original: _____



42 dentes / teeth

Motor de Partida / Starter: _____

Aplicação / Application: HYSTER:EMPILHADEIRA / FORKLIFT, RENAULT

APLICAÇÃO / Application: UF-15.104

Mitsubishi

R - 0099

Original: _____

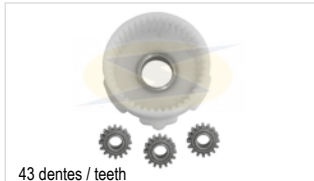

43 dentes / teeth

Motor de Partida / Starter: Mando, Mitsubishi PMGR

Aplicação / Application: AMC (1985→2000), CHEVROLET-GM, CHRYSLER, DODGE, EAGLE, FORD, GEO, HYUNDAI, INFINITI, JEEP, MAZDA, MERCURY, MITSUBISHI, NISSAN, PLYMOUTH, SUBARU, SUZUKI, CATERPILLAR, CLARK

Mitsubishi / Delco

R - 0100

Original: _____

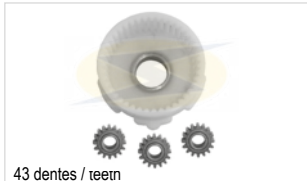

43 dentes / teeth

Motor de Partida / Starter: CGP 25

Aplicação / Application: CHEVROLET-GM: OMEGA / SUPREMA GLS (1995→1998) / CD 6CC 4.1 MPFI, CLARK: EMPILHADEIRA / FORKLIFT, MITSUBISHI: EMPILHADEIRA / FORKLIFT, PAJERO V6 GAS.

APLICAÇÃO / Application: UF-15.101 / UF-14.711

Mitsubishi

R - 0101

Original: _____



44 dentes / teeth

Motor de Partida / Starter: M 002 T87 771, M 002 T87 171 ZT

Aplicação / Application: CHEVROLET-GM: S-10 C/ MOTOR MWM 2.8 SPRINT, MITSUBISHI: L200 SPORT HPE, TROLLER: T4 2.8 TD MWM 4 CC SPRINT (2001→)

APLICAÇÃO / Application: UF-15.103

Mitsubishi

R - 0102

Original: _____



44 dentes / teeth

Motor de Partida / Starter: M 002 T87 771, M 002 T87 171 ZT

Aplicação / Application: CHEVROLET-GM: S-10 C/ MOTOR MWM 2.8 SPRINT, MITSUBISHI: L200 SPORT HPE, TROLLER: T4 2.8 TD MWM 4 CC SPRINT (2001→)

APLICAÇÃO / Application: UF-15.103

Mitsubishi

R - 0103

Original: _____



Motor de Partida / Starter: M001T79781 12V, M002T87771, M002T87171 ZT

Aplicação / Application: CLARK, MITSUBISHI, CHEVROLET-GM, HYSTER, RENAULT

APLICAÇÃO / Application: UF-15.101 / UF-15.103 / UF-15.104 - REPARO AMORTECEDOR

Valeo

R - 0068

Original: _____



37 dentes / teeth

Motor de Partida / Starter: D6RA85.185

Aplicação / Application: CHEVROLET-GM, RENAULT, PEUGEOT, CITROEN

APLICAÇÃO / Application: UF-16.102

Valeo

R - 0069

Original: _____



59 dentes / teeth

Motor de Partida / Starter: D6RA65, 165

Aplicação / Application: CHEVROLET-GM, RENAULT, PEUGEOT, CITROEN

APLICAÇÃO / Application: UF-16.103

Prestolite **R - 0082** Original: 1 126 600 975



39 dentes / teeth

Motor de Partida / Starter:	352.58.040,	352.58.580,
	352.58.940,	352.58.950,
	352.58.490,	352.58.540,
	352.58.660,	352.58.690,
	352.58.710,	352.58.820,
	352.58.880,	352.58.940,
	352.58.950,	352.58.960,
	352.58.990,	352.59.000,
	352.59.040,	352.59.130,
	352.59.210,	352.59.380,
	352.59.465,	352.59.480,
	352.59.620,	352.59.630,
	352.59.650,	352.59.660,
	352.59.670,	

352.59.680, 352.59.690, 352.59.915, 352.59.952

Aplicação / Application: **AGRALE:** ÔNIBUS VOLARE, **CHEVROLET-GM:** BLAZER DLX, PICK-UP S10 C/ MOTOR MAXION HS, PICK-UP D20, SILVERADO C/ MOTOR MWM, **CUMMINS:** MOTORES SÉRIES 6BT (DIANTEIRO) / B6 / BT5.9L, **FORD:** CARGO 1416 / 1722 / 1716, F-14000 C/ MWM, F-1000, RANGER, **JOHN DEERE:** TRATORES, **MASSEY-FERGUSON:** TRATOR C/ MOTOR 4 CIL, **MAXION:** MOTORES, **MERCEDES-BENZ:** 180D - KOMBI ESPANHOLA, ÔNIBUS, CAMINHÕES, MB 180 D, ÔNIBUS, SPRINTER C/ MOTOR MAXION HS, **PERKINS:** MOTORES 4.203 / 3.152 / 4.236 / 6.354, **PEUGEOT:** 504, 505, VÁRIOS C/ MOTOR INDENOR, **VOLKSWAGEN:** CAMINHÃO 15-160

APLICAÇÃO / Application: UF- 12.147 / 12.149 / 12.212 / 12.219 / 12.221 / 12.222 / 12.343

Prestolite **R - 0095** Original:

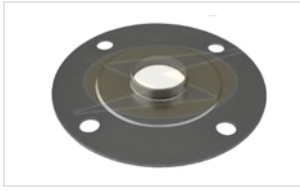

Motor de Partida / Starter:	352.58.040,	352.58.580,
	352.58.940,	352.58.950,
	352.58.490,	352.58.540,
	352.58.660,	352.58.690,
	352.58.710,	352.58.820,
	352.58.880,	352.58.940,
	352.58.950,	352.58.960,
	352.58.990,	352.59.000,
	352.59.040,	352.59.130,
	352.59.210,	352.59.380,
	352.59.465,	352.59.480,

352.59.620, 352.59.630, 352.59.650, 352.59.660, 352.59.670, 352.59.680, 352.59.690, 352.59.915, 352.59.952

Aplicação / Application: **AGRALE:** ÔNIBUS VOLARE, **CHEVROLET-GM:** BLAZER DLX, PICK-UP S10 C/ MOTOR MAXION HS, PICK-UP D20, SILVERADO C/ MOTOR MWM, **CUMMINS:** MOTORES SÉRIES 6BT (DIANTEIRO) / B6 / BT5.9L, **FORD:** CARGO 1416 / 1722 / 1716, F-14000 C/ MWM, F-1000, RANGER, **JOHN DEERE:** TRATORES, **MASSEY-FERGUSON:** TRATOR C/ MOTOR 4 CIL, **MAXION:** MOTORES, **MERCEDES-BENZ:** 180D - KOMBI ESPANHOLA, ÔNIBUS, CAMINHÕES, MB 180 D, ÔNIBUS, SPRINTER C/ MOTOR MAXION HS, **PERKINS:** MOTORES 4.203 / 3.152 / 4.236 / 6.354, **PEUGEOT:** 504, 505, VÁRIOS C/ MOTOR INDENOR, **VOLKSWAGEN:** CAMINHÃO 15-160.

APLICAÇÃO / Application: UF- 12.147 / 12.149 / 12.212 / 12.219 / 12.221 / 12.222 / 12.343

Prestolite **R - 0104** Original: K01189, K01256

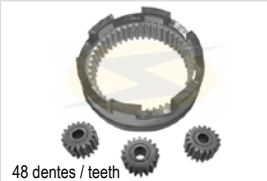

48 dentes / teeth

Motor de Partida / Starter:	35259200,	35259240,	35259260,
	35259290,	35259340,	35259360,
	35259440,	35259450,	35259460,
	35259500,	35259520,	35259550,
	35259730,	35259770,	35259780,
	35259810,	35259820,	35259830,
	35259840,	35260830,	35260840,
	35260870,	35260900,	35260910,
	35261000,	35261050,	35261130,
	35261135,	35261160,	35261185,
	35261345,	35261385,	35261395,

35261445, 35261680, 35261690, 35261740, 35261770, 35261780, 35261900, 35262010, 35262020, 35262130, 35262190

Aplicação / Application: **AGRALE:** MARRUÁ MWM SPRINT 4.07, **CATERPILLAR:** BLUE BIRD USA CAT 3126 7.2 / 7.2 (OCP), **CUMMINS:** ISB02 5.8C 8.3B / ELET., 5.9 C, 6CT 8.3C, 6CTA 8.3C, **CNH (CASE, NEW HOLLAND):** LÍNEA TM EXITUS: TM135 / TM150 / TM150 / TM165 / TM180 / TS100 / TS110 / TS120, GENESIS POWERSTAR, **DEUTZ:** ÔNIBUS DEUTZ 1013 L6, **DIMEX:** CAMINHÃO CUMMINS C, **DON ROQUE:** COLHEITADEIRA / **COMBINE** RV125, RV150H CUMMINS C8.3 / ELECT, **JOHN DEERE:** 7820 6081H 6 CIL., COLHEITADEIRA / **COMBINE** 1550, 6081H 6 CIL. 8.12, TRATOR 6 CIL. - 5410 4045D 4 CIL.4.5 - 5600 4039D 4 CIL. 3.9 - 5700 4039T 4 CIL. 3.9 - 6300 4039T 4 CIL. 3.9 - 6600 6059T 6 CIL. 5.9 - 5320N, 3029T 3 CIL. 2.9 - 5520N 4045T 4 CIL. 4.5, BULLDOZER 570 / 570 A 6 CIL. - TRATOR 627 / 727 6 CIL. - TRATOR 1420 / 2330 / 2420 / 2530 / 2730 TODOS 3 E 4 CIL. - TRATOR 2850 6.359 / 3140 6.359 / 3350 6.359 / 3540 6.359 / 3550 6.359 4.239 D. - TRATOR 3420 / 3530 / 4420 / 4530 / 6005 / 7505 TODOS 6 CIL., **FORD:** CUMMINS B 5.9, CARGO 2422 / 2425 / 2630 CUMMINS 6CTAA 8.3, CARGO 2425 MIXER CUMMINS 6CTAA 8.3, CAMINHÃO F650 CAT3126 7.2 (OCP), **FREIGHTLINER:** NAVISTAR V8 7.3, **GRANDALL:** TRATOR 4045 JOHN DEERE 4CIL. 4.5, **INTERNACIONAL ENGINES:** CAMINHÃO NAVISTAR DT446 - I6 7.6, DT444E, V8 7.3, DT-360 5.9, 6.0, NGV - V8 6.0, **VALTRA:** TRATOR BH140 / BH160 / BH180 SISU 6CIL., TRATOR BL77 SISU 3CIL., TRATOR BL88 / BM100 / BM110 / BM120 SISU 4CIL., TRATOR LIVIANO 685C / 785C MWM 3CIL., TRATOR PESADO 1280 / 1580 / 1780 MWM 6CIL., **MBB:** O371 6CIL., OF215 6CIL., ÔNIBUS 1214 / 1414 / 1418 / 1614 CAIXA AUTOMÁTICA, **PAUNI:** MINIBUS CUMMINS 4BT 3.9, **MWN:** 4 E 6CIL., MWM SERIES X10 E 229 SERIES, **VM ÔNIBUS:** MWM 4 E 6CIL., MINIBUS CUMMINS 6B ELETRÔNICO 5.9, **VW CAMINHÕES:** CAMINHÃO PESADO 17.220 / 26.220 / 26.260 CUMMINS 6CTAA 8.3, CAMINHÃO 23.220 CUMMINS, 6CTAA 8, TITAN 17.310 / 18.310 / 23.310 / 26.310 TODOS CUMMINS 6CTAA 8.3, **VOLVO:** LÍNEA VM: VM17 / VM23 MWM SERIES X10 E 229 SERIES, **ZANELLO:** TRATOR 160 / 180, PTRAC CUMMINS B 5.9

APLICAÇÃO / Application: UF - 12.100

Prestolite **R - 0111** Original:

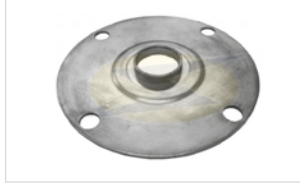

Motor de Partida / Starter:	35259200,	35259240,
	35259260,	35259290,
	35259340,	35259360,
	35259440,	35259450,
	35259460,	35259500,
	35259520,	35259550,
	35259730,	35259770,
	35259780,	35259810,
	35259820,	35259830,
	35259840,	35260830,
	35260840,	35260870,
	35260900,	35260910,
	35261000,	35261050,
	35261130,	35261135,
	35261160,	35261185,
	35261345,	35261385,
	35261395,	35261445,
	35261680,	35261690,
	35261740,	35261770,
	35261780,	35261900,
	35262010,	35262020,
	35262130,	35262190,

Aplicação / Application: **AGRALE:** MARRUÁ MWM SPRINT 4.07, **CATERPILLAR:** BLUE BIRD USA CAT 3126 7.2 / 7.2 (OCP), **CUMMINS:** ISB02 5.8C 8.3B / ELET., 5.9 C, 6CT 8.3C, 6CTA 8.3C, **CNH (CASE, NEW HOLLAND):** LÍNEA TM EXITUS: TM135, TM150, TM150, TM165, TM180, TS100, TS110, TS120, GENESIS POWERSTAR, **DEUTZ:** ÔNIBUS DEUTZ 1013 L6, **DIMEX:** CAMINHÃO CUMMINS C, **DON ROQUE:** COLHEITADEIRA / **COMBINE** RV125, RV150H CUMMINS C8.3 / ELECT, **JOHN DEERE:** 7820 6081H 6 CIL., COLHEITADEIRA / **COMBINE** 1550, 6081H 6 CIL. 8.12, TRATOR 6 CIL. - 5410 4045D 4 CIL.4.5 - 5600 4039D 4 CIL. 3.9 - 5700 4039T 4 CIL. 3.9 - 6300 4039T 4 CIL. 3.9 - 6600 6059T 6 CIL. 5.9 - 5320N, 3029T 3 CIL. 2.9 - 5520N 4045T 4 CIL. 4.5, BULLDOZER 570 / 570 A 6 CIL. - TRATOR 627 / 727 6 CIL. - TRATOR 1420 / 2330 / 2420 / 2530 / 2730 TODOS 3 E 4 CIL. - TRATOR 2850 6.359 / 3140 6.359 / 3350 6.359 / 3540 6.359 / 3550 6.359 4.239 D. - TRATOR 3420 / 3530 / 4420 / 4530 / 6005 / 7505 TODOS 6 CIL., **FORD:** CUMMINS B 5.9, CARGO 2422 / 2425 / 2630 CUMMINS 6CTAA 8.3, CARGO 2425 MIXER CUMMINS 6CTAA 8.3, CAMINHÃO F650 CAT3126 7.2 (OCP), **FREIGHTLINER:** NAVISTAR V8 7.3, **GRANDALL:** TRATOR 4045 JOHN DEERE 4CIL. 4.5, **INTERNACIONAL ENGINES:** CAMINHÃO NAVISTAR DT446 - I6 7.6, DT444E, V8 7.3, DT-360 5.9, 6.0, NGV - V8 6.0, **VALTRA:** TRATOR BH140 / BH160 / BH180 SISU 6CIL., TRATOR BL77 SISU 3CIL., TRATOR BL88 / BM100 / BM110 / BM120 SISU 4CIL., TRATOR LIVIANO 685C / 785C MWM 3CIL., TRATOR PESADO 1280 / 1580 / 1780 MWM 6CIL., **MBB:** O371 6CIL., OF215 6CIL., ÔNIBUS 1214 / 1414 / 1418 / 1614 CAIXA AUTOMÁTICA, **PAUNI:** MINIBUS CUMMINS 4BT 3.9, **MWN:** 4 E 6CIL., MWM SERIES X10 E 229 SERIES, **VM ÔNIBUS:** MWM 4 E 6CIL., MINIBUS CUMMINS 6B ELETRÔNICO 5.9, **VW CAMINHÕES:** CAMINHÃO PESADO 17.220 / 26.220 / 26.260 CUMMINS 6CTAA 8.3, CAMINHÃO 23.220 CUMMINS, 6CTAA 8, TITAN 17.310 / 18.310 / 23.310 / 26.310 TODOS CUMMINS 6CTAA 8.3, **VOLVO:** LÍNEA VM: VM17 / VM23 MWM SERIES X10 E 229 SERIES, **ZANELLO:** TRATOR 160 / 180, PTRAC CUMMINS B 5.9

APLICAÇÃO / Application: UF - 12.100

Bosch

UF - 7.701

Especificações / Features: **Comprimento / Length: 323 mm**



Original: 2 003 050 056

Partida / Starter: KB, 0 001 410 016, 0 001 410 019, 0 001 410 021, 0 001 410 041, 0 001 410 046, 0 001 410 050

Aplicação / Application: CASE, CATERPILLAR, FIAT-ALLIS: CAMINHÕES, IVECO: CAMINHÕES, KOMATSU, MERCEDES-BENZ, SCANIA, VOLSWAGEN: CAMINHÕES, VOLVO

Bosch / Delco

UF - 7.702

Especificações / Features: **Comprimento / Length: 289,5 mm**



Original: BOSCH: 2 003 050 076, DELCO: 19024393

Partida / Starter: 19024013, 19024038, 19024135

Aplicação / Application: VOLVO, MERCEDES: CAMINHÃO E ÔNIBUS 24V

Bosch / Delco

UF - 7.703

Especificações / Features: **Comprimento / Length: 324,5 mm**



Original: BOSCH: 2 003 050 075, DELCO: 19024392

Partida / Starter: 19024079

Aplicação / Application: SCANIA: CAMINHÃO E ÔNIBUS 24V

Bosch

UF - 7.704

Especificações / Features: **Comprimento / Length: 308,5 mm**



Original: BOSCH: 2 003 050 040

Partida / Starter: 0 001 417 001, 0 001 417 002, 0 001 417 012, 0 001 417 013, 0 001 417 022

Aplicação / Application: MERCEDES-BENZ

Mancal Intermediário KB | Drive Shaft Frame KB

Bosch

UF - 8.801

Especificações / Features:



Original: 2 005 825 077

Partida / Starter: KB

Aplicação / Application: CASE, CATERPILLAR, FIAT-ALLIS: CAMINHÕES, IVECO: CAMINHÕES, KOMATSU, MERCEDES-BENZ, SCANIA, VOLSWAGEN: CAMINHÕES, VOLVO



Bosch **UF - 8.802**

Especificações / Features: Tipo/ Type: KB

Original: 2 000 580 121

Partida / Starter: KB TODAS / ALL

Aplicação / Application: CASE, CATERPILLAR, FIAT-ALLIS, IVECO, KOMATSU, MERCEDES-BENZ, SCANIA, VOLVO, VOLKSWAGEN

Mancal do Coletor e Arruelas EF | Brackets C.E. and Washer EF



Bosch **UF - 8.803**

Especificações / Features: Tipo/ Type: EF, 12V - 0,70 Kw e 0,80 Kw

Original: 2 005 852 008

Partida / Starter: 0 001 211 209, 0 001 211 210, 0 001 211 218, 0 001 211 219, 9 000 082 021, 9 000 082 025, 9 000 082 028, 9 000 082 030, 9 000 082 045, 9 000 082 051, 9 000 082 082

Aplicação / Application: **AGRALE-DEUTZ:** 4100, M70 / 80 / 85 / 90 / 93ID, TX1100, **CHEVROLET-GM:** CHEVETTE, HATCH, CHEVY 500, MARAJÓ, **FIAT:** PREMIO / RALLY / SPAZIO, DUNA 60 / 70 / WEEKEND, UNO 1.1 / MILLE / ELX / EP, 147 FIORINO 1.5, ELBA 1.5, PRÊMIO 1.5, UNO 1.5 / 1.6, 147 / 147 CITY / EUROPA / FIORINO / GLS / OGGI / PANORAMA / PICK-UP / ELBA 1.5, PRÊMIO 1.5, TEMPRA 2.0 MPI / SPI 16V / 8V, TEMPRA 2.0 TURBO, TIPO 1.6 I.E., UNO 1.6 MPI, **FORD:** BELLINA 1.8, DEL REY 1.8, PAMPA 1.8, ROYALE 1.8 / 2.0, VERSAILLES 1.8 / 2.0, **GURGEL:** BR 800, TOCANTINS L, TR, **VOLKSWAGEN:** SEDAN, SUPERMINI, KARMANN GHIA 1600, SP, 600 / 1700, VARIANT II 1600, BRASÍLIA 1.3/1.6, FUSCA 1300 / 1500 / 1600, 302, 307, 309, GOL 1.8, KOMBI 1.6, GOL 1.0, GOL II 1.0i, II / III / 1.6, SAVEIRO 1.6, VOYAGE 1.6, SAVEIRO 1.6, VOYAGE 1.5 / 1.6, QUANTUM 2.0i, SANTANA 2.0i, **YANMAR:** BT22 / 23MICROTRATORES CT 11 / TC 11 SUPER, **LADA:** NIVA 1.5 / 1.6, **MOTORES TIETE:** 950 / 950 L

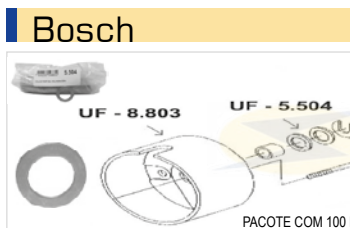

Bosch **UF - 5.504**

Especificações / Features: Tipo/ Type: EF, 12V - 0,70 Kw e 0,80 Kw

PACOTE COM 100 PEÇAS / PACKAGE WITH 100 PIECES

Buchas do Alternador | Bushing for Alternators



Bosch **UF - 5.506**

Especificações / Features: PARA ROLAMENTO / BEARING Nº 6201

Original: 1 120 591 060

Alternador / Alternator:

Aplicação / Application: CASE, IVECO, VOLVO, SCANIA, MERCEDES-BENZ, FORD, CARGO



Bosch **UF - 5.507**

Especificações / Features: PARA ROLAMENTO / BEARING Nº 6201

Original: 1 120 591 082

Alternador / Alternator:

Aplicação / Application: CHEVROLET-GM, VALMET, FORD, VOLKSWAGEN



Bosch **UF - 5.508**

Especificações / Features: PARA ROLAMENTO / BEARING Nº 6203

Original: 1 120 591 103

Alternador / Alternator:

Aplicação / Application: CHEVROLET-GM, VOLKSWAGEN

LP-0001

Conjunto Completo / Complete Part

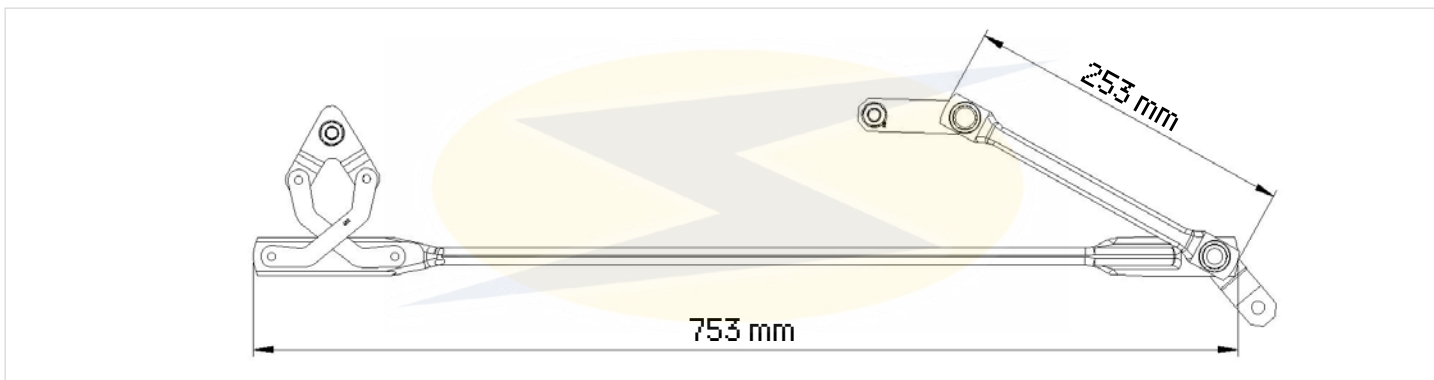
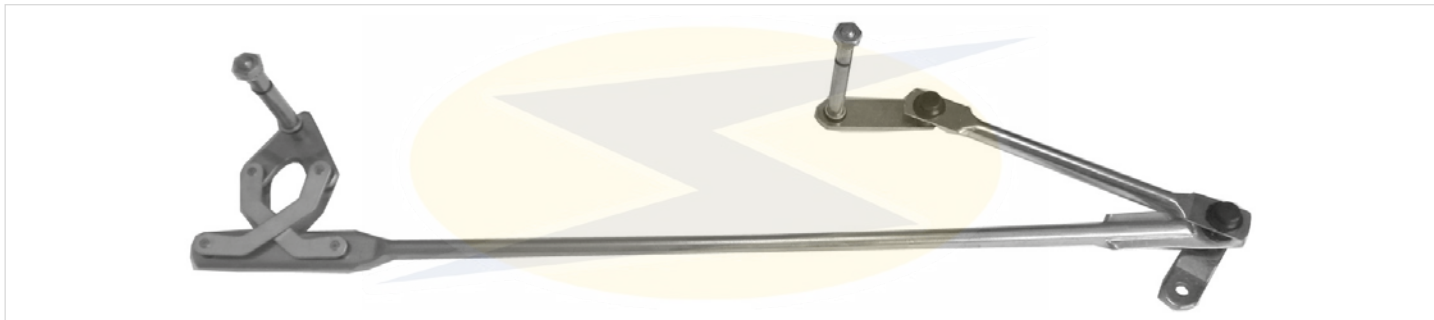

Aplicação / Application: **MBB:** (CARA CHATA) 1938S, 1944S (1998→), ATEGO E AXOR (→2006)
 LP-0001-01 TAMBÉM APLICA / ALSO APPLIES IN **VOLVO:** NH (1999→)

LP-0001: Reparos | Repairs

LP-0001-01

Barra Longa / Long Arm

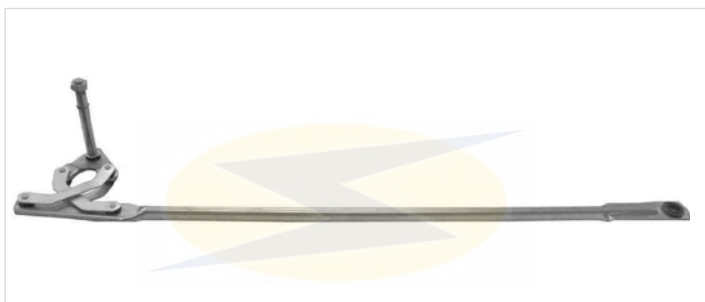

LP-0001-02

Barra Curta / Short Arm



LP-0001-03

Pivô / Pivot



LP-0001-04

Manivela / Crank Arm

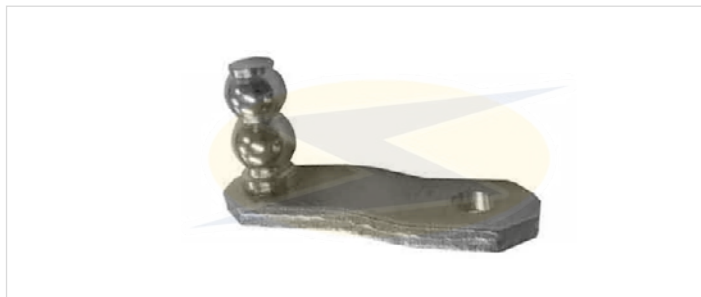

LP-0002 **Conjunto Completo / Complete Part**

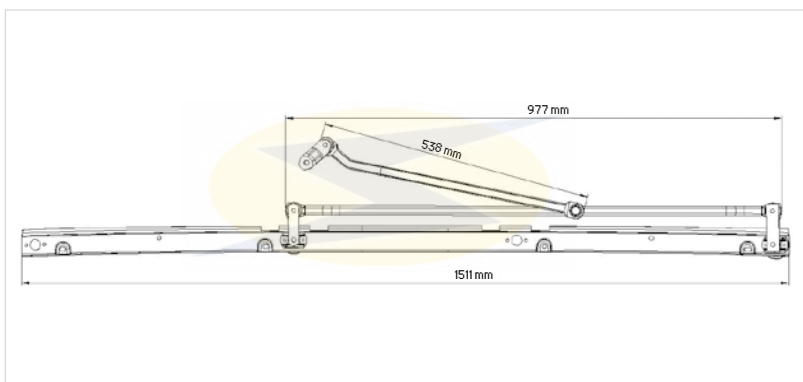

LP-0002 : Reparos | Repairs

LP-0002SS Conjunto sem suporte / Part without Bracket Set

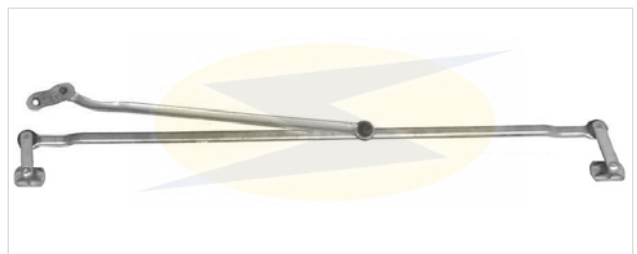

Aplicação / Application: **MBB:** LS 1938 (1997→), 1942, 2219 (LADO ESQUERDO DO MOTOR) / **LEFT SIDE MOTOR**

LP-0002-01 Barra Longa / Long Arm | **LP-0022-02 Barra Curta / Short Arm** | **LP-0002-03 Pivô Longo / Long Pivot**

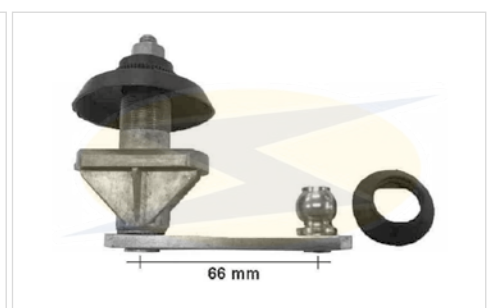
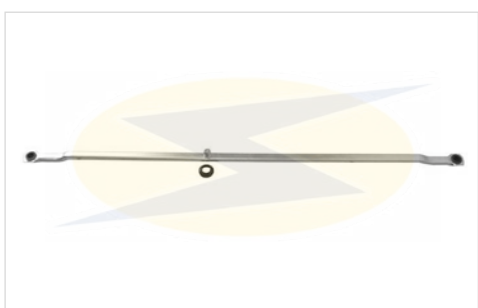

LP-0002-04 Pivô Curto / Short Pivot | **LP-0022-05 Manivela / Crank Arm** | **LP-0002-06 Suporte do Conjunto / Bracket Set**

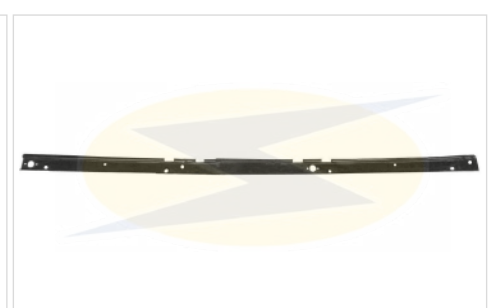
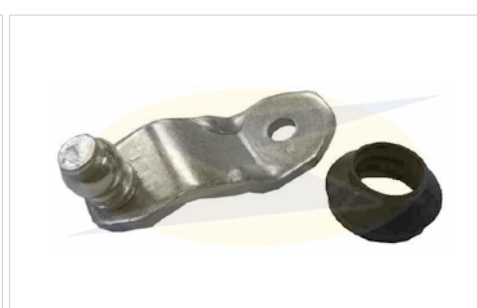

LP-0003

Conjunto Completo / Complete Part

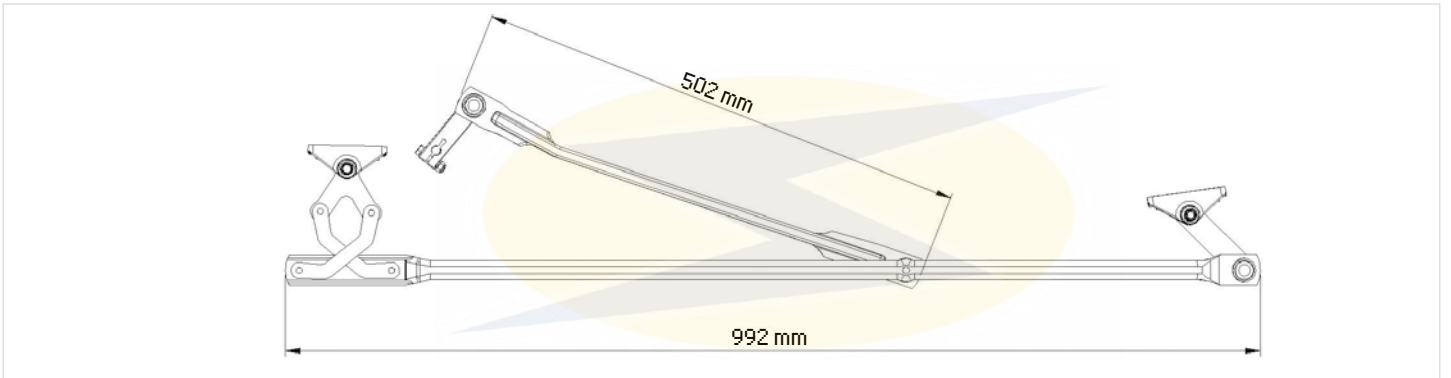
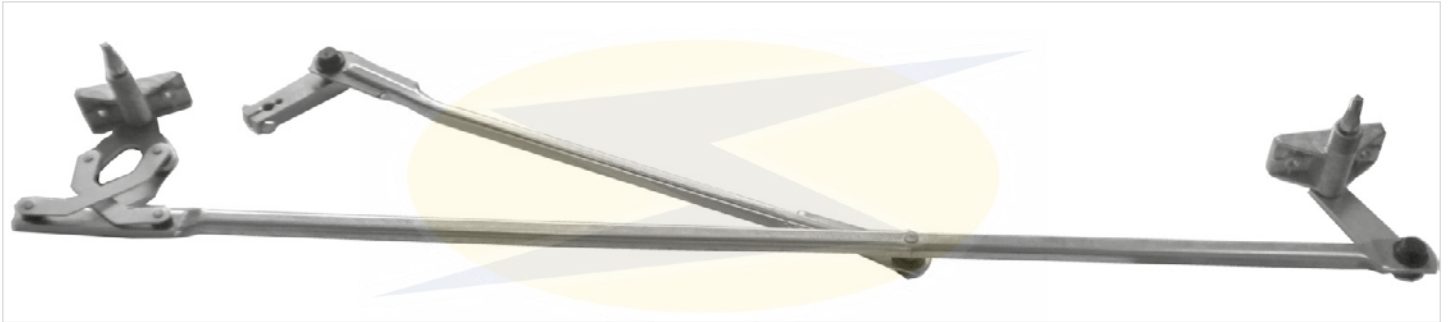

Aplicação / Application: SCANIA: T113, T143 (1993→), R113, R143 (1991→)

LP-0003 : Reparos | Repairs

LP-0003-01

Barra Longa / Long Arm



LP-0003-02

Barra Curta / Short Arm

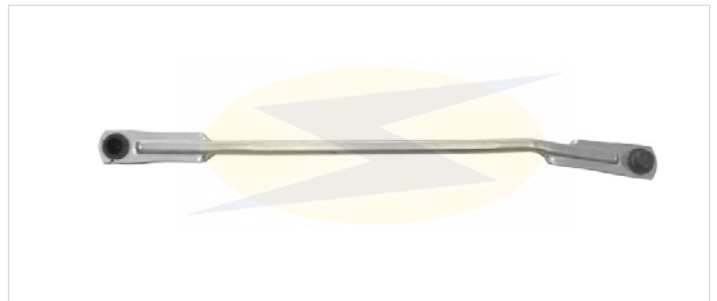

LP-0003-03

Pivô / Pivot

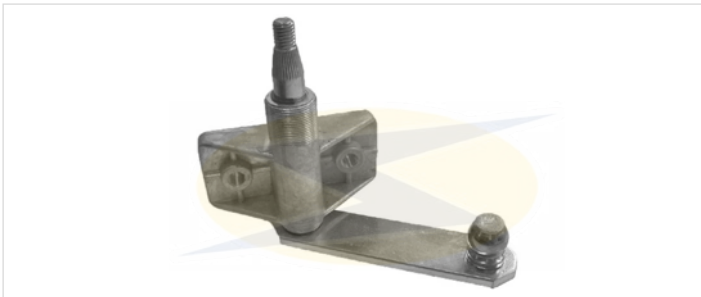

LP-0003-04

Manivela / Crank Arm



LP-0004

Conjunto Completo / Complete Part

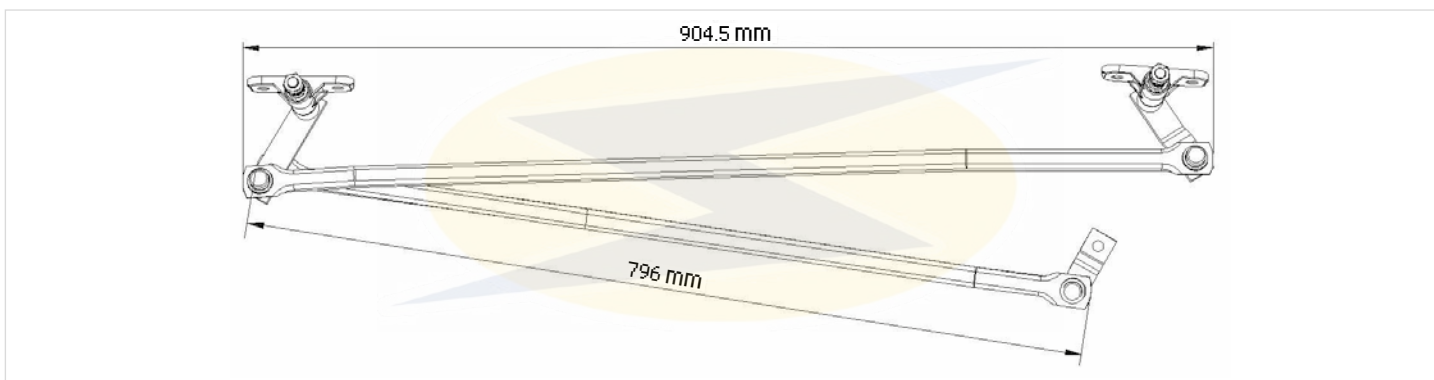
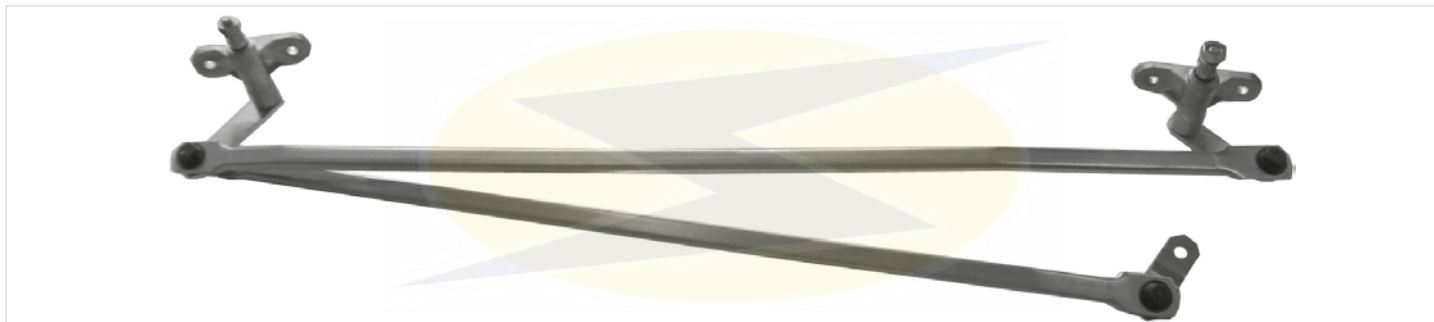

Aplicação / Application: **SCANIA: SÉRIE 4 (1998→)**

LP-0004: Reparos | Repairs

LP-0004-01

Barra Longa / Long Arm



LP-0004-02

Barra Curta / Short Arm

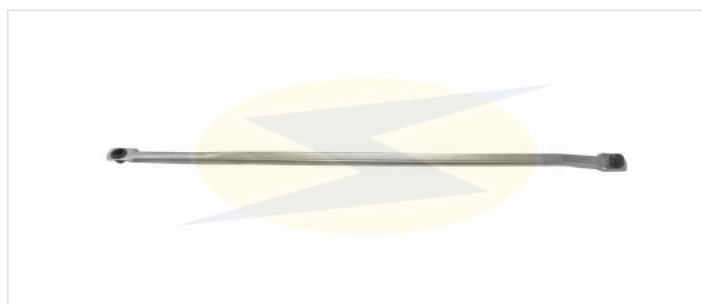

LP-0004-03

Pivô Longo / Long Pivot

LP-0004-04

Pivô Curto / Short Pivot

LP-0004-05

Manivela / Crank Arm

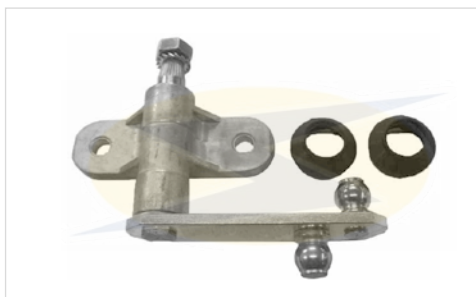

LP-0005

Conjunto Completo / Complete Part

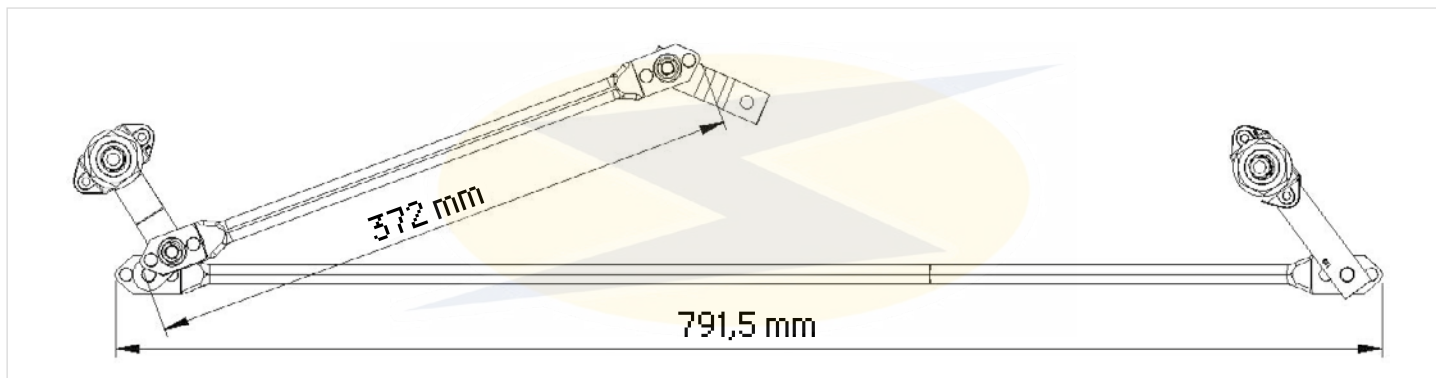
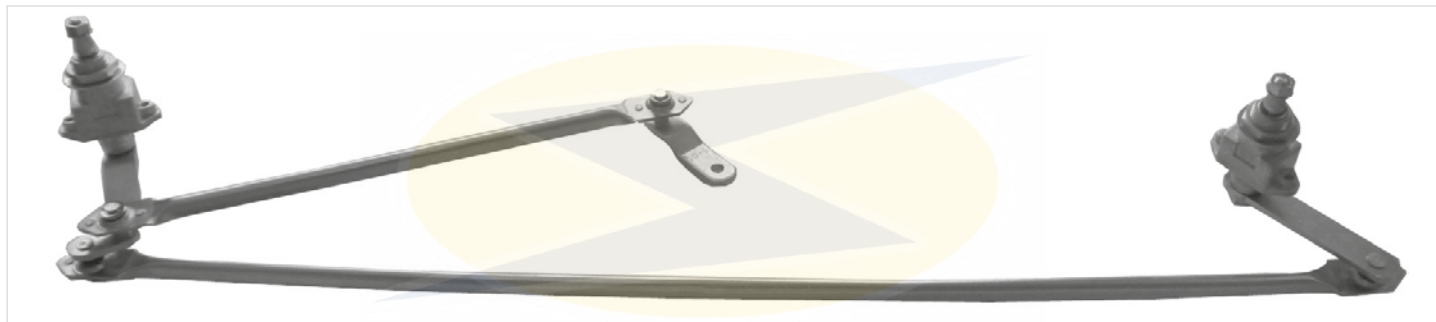

Aplicação / Application: FORD: CARGO (TODOS) / (ALL)

LP-0005: Reparos | Repairs

LP-0005-01

Barra Longa / Long Arm



LP-0005-02

Barra Curta / Short Arm



LP-0005-03

Pivô Longo / Long Pivot



LP-0005-04

Pivô Curto / Short Pivot



LP-0005-05

Manivela / Crank Arm



LP-0006 **Conjunto Completo / Complete Part**

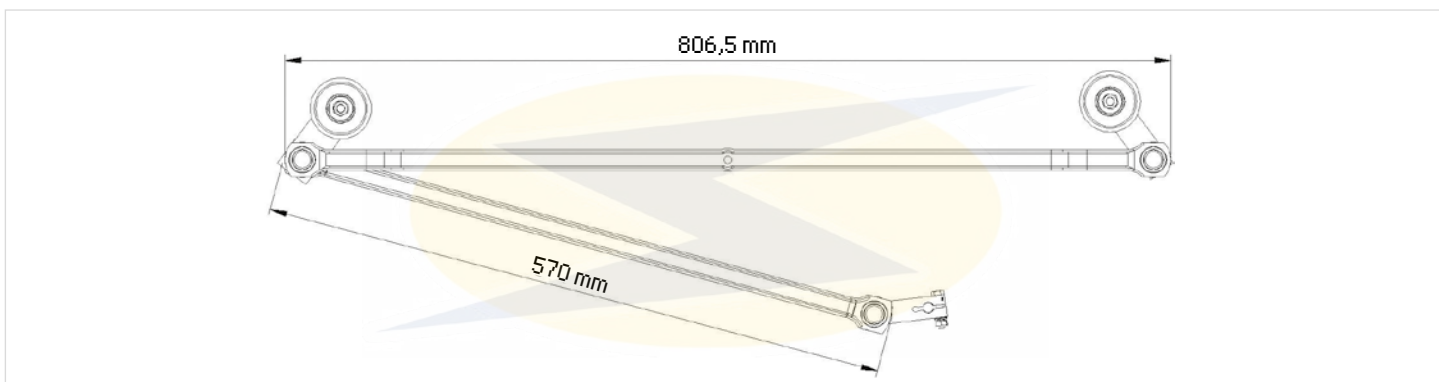

Aplicação / Application: MBB: 709, 710, 711, 712, 914, 1114, 1620, CARA CHATA, SÉRIE L (1988→)
(LADO DIREITO DO MOTOR / RIGHT SIDE MOTOR)

LP-0006: Reparos | Repairs

LP-0006-01 Barra Longa / Long Arm

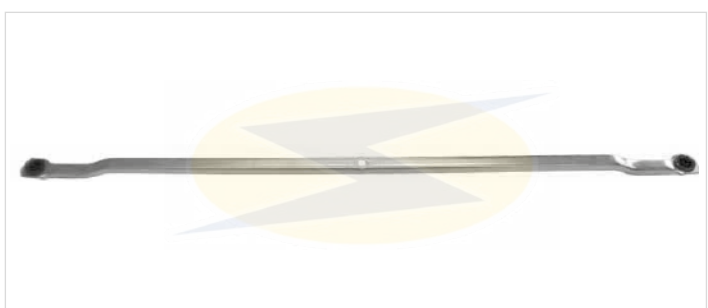

LP-0006-02 Barra Curta / Short Arm

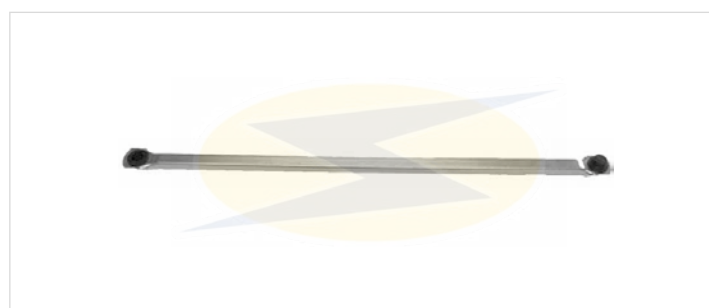

LP-0006-03 Pivô Longo / Long Pivot



LP-0006-04 Pivô Curto / Short Pivot



LP-0006-05 Manivela / Crank Arm



LP-0007

Conjunto Completo / Complete Part

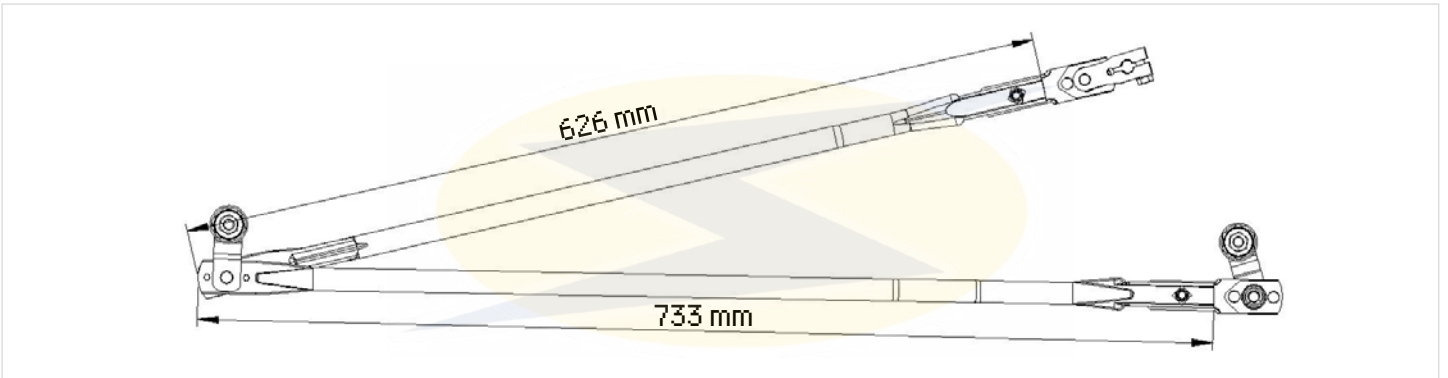
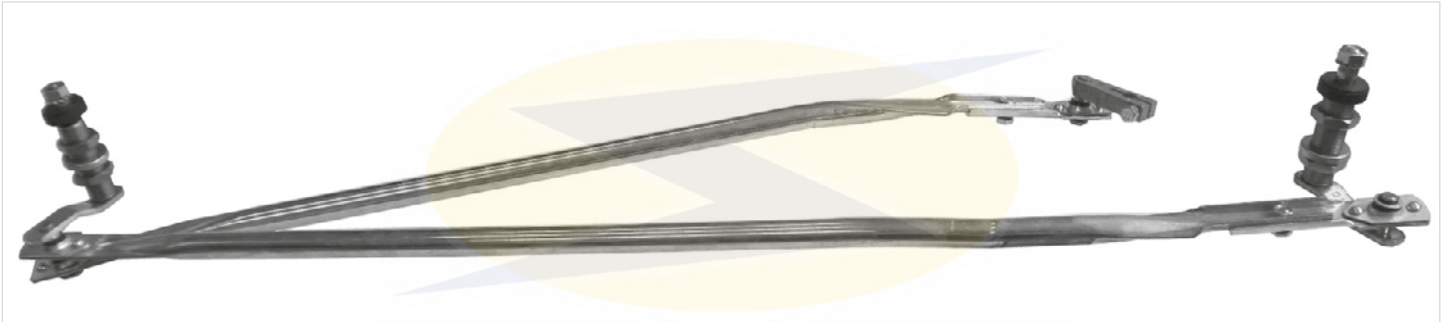

Aplicação / Application: MBB: L-608, L-708 (→1988)

LP-0007: Reparos | Repairs

LP-0007-01

Barra Longa / Long Arm

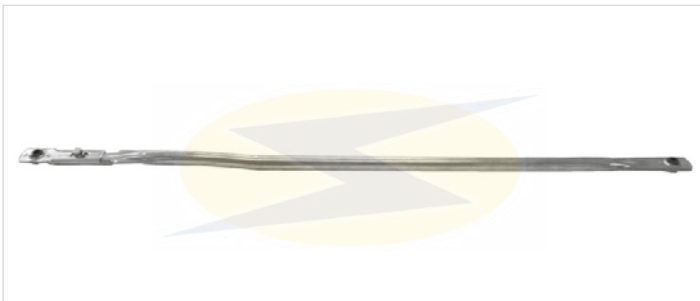

LP-0007-02

Barra Curta / Short Arm



LP-0007-03 **Pivô Esquerdo / Left Pivot**

LP-0007-04 **Pivô Direito / Right Pivot**

LP-0007-05 **Manivela / Crank Arm**



LP-0008 **Conjunto Completo / Complete Part**

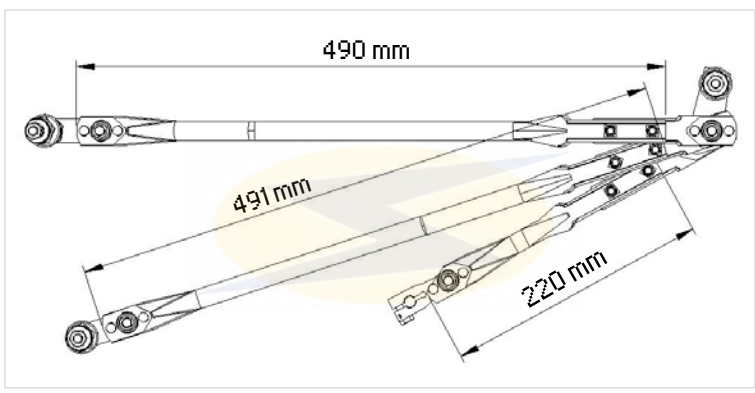
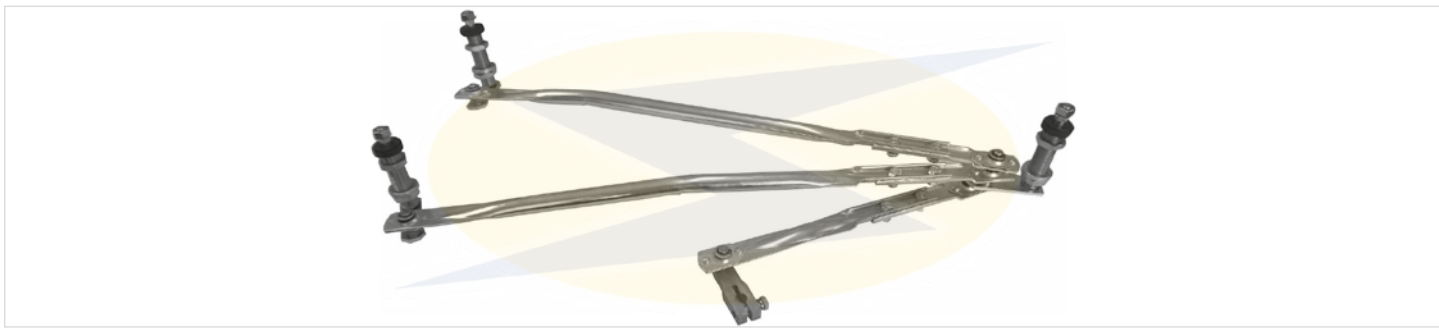

LP-0008: Reparos | Repairs

LP-0008-01 **Barra Longa / Long Arm**



Aplicação / Application: **MBB: 3 LIMPADORES / WIPERS (1975→1988)**

LP-0008-02 Barra Média / Medium Arm **LP-0008-03 Barra Curta / Short Arm** **LP-0008-04 Pivô Esquerdo / Left Pivot**

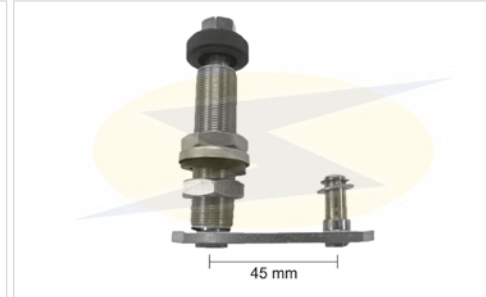
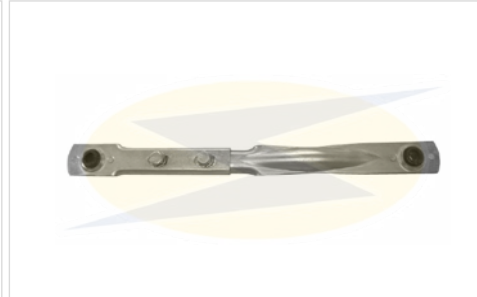
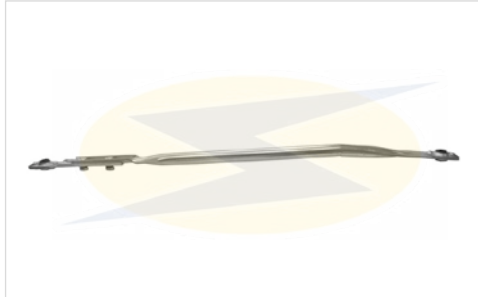

LP-0008-05 Pivô Central / Center Pivot **LP-0008-06 Pivô Direito / Right Pivot** **LP-0008-07 Manivela / Crank Arm**

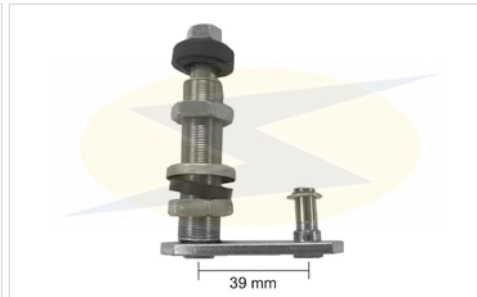

LP-0009

Conjunto Completo / Complete Part

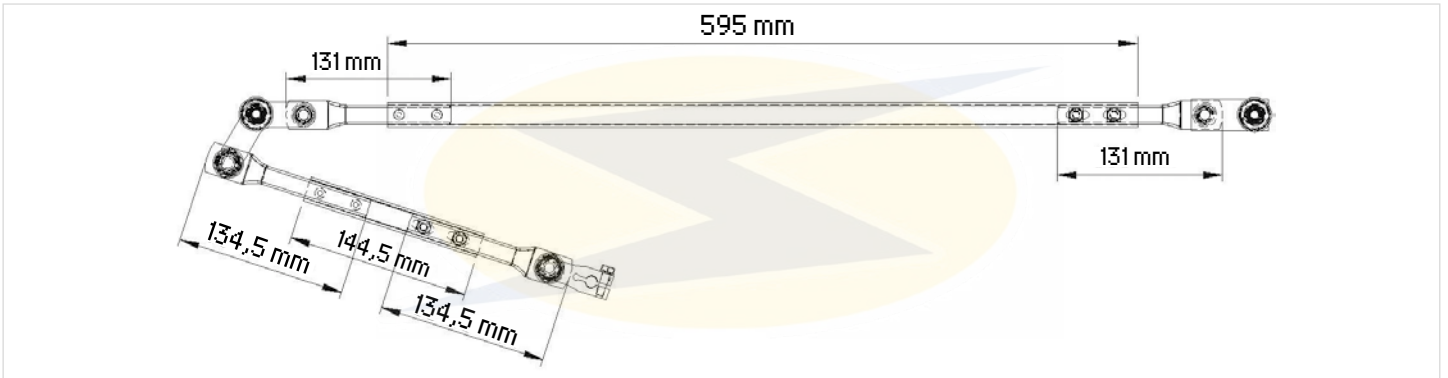
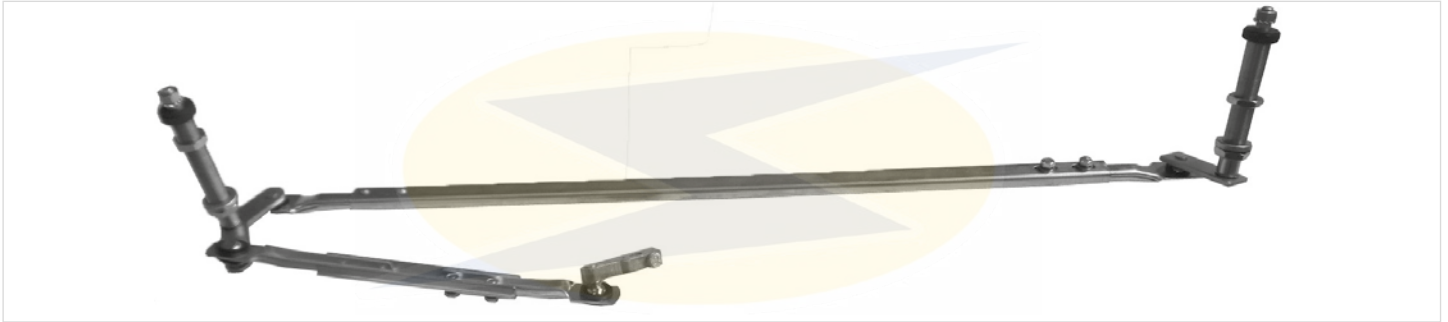

Aplicação / Application: VOLVO: N10, 12, NL10, 12 (1981→)

LP-0009: Reparos | Repairs

LP-0009-01

Barra Longa / Long Arm

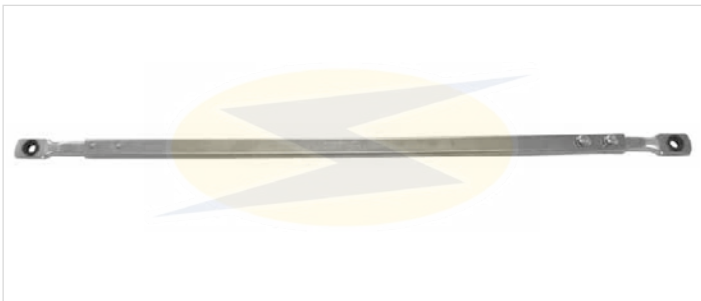

LP-0009-02

Barra Curta / Short Arm

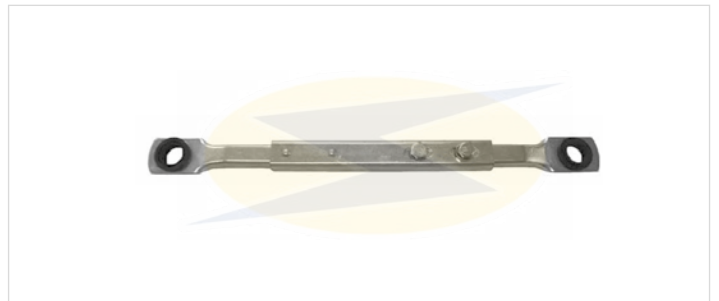

LP-0009-03 Terminal "V" / "V" Link

LP-0009-04 Terminal / Link

LP-0009-05

Manivela / Crank Arm



LP-0010 Conjunto Completo / Complete Part

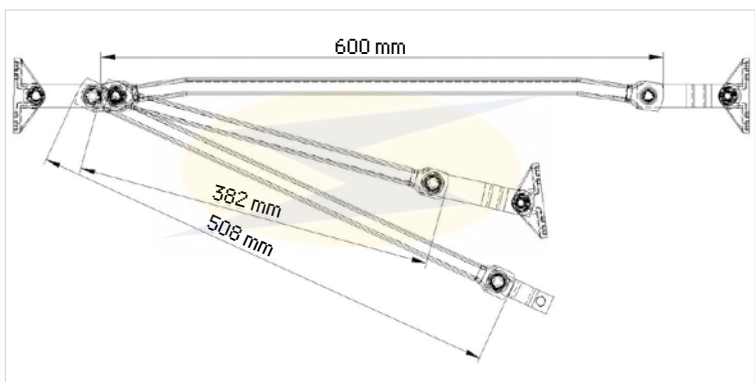
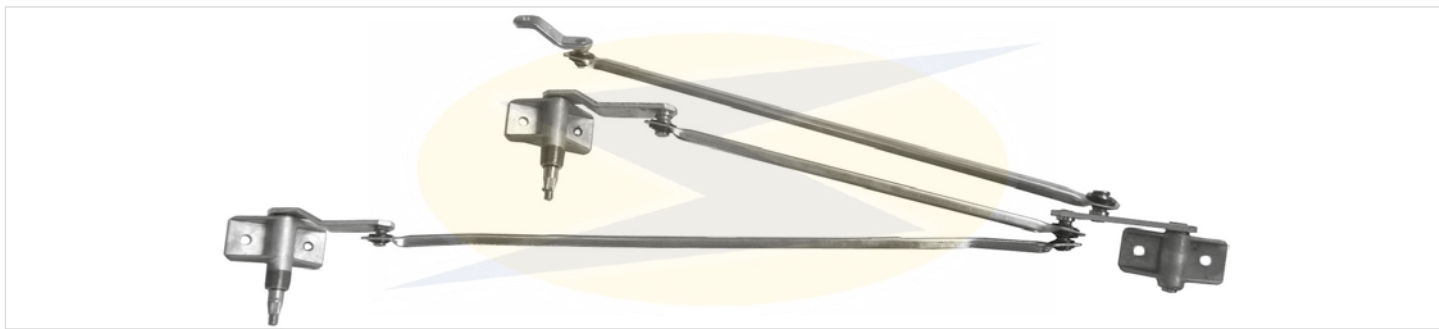

LP-0010: Reparos | Repairs

LP-0010-01 Barra Longa / Long Arm



Aplicação / Application: SCANIA: T112, T142, R112, R142 (1981→)

LP-0010-02 Barra Média / Medium Arm | **LP-0010-03** Barra Curta / Short Arm | **LP-0010-04** Pivô Curto / Short Pivot

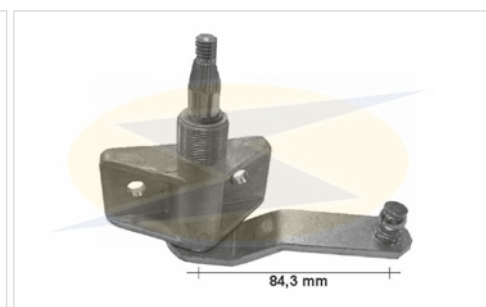
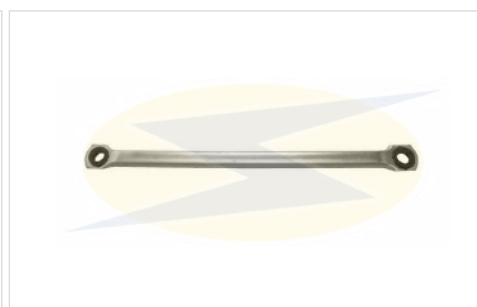

LP-0010-05 Pivô Longo / Long Pivot | **LP-0010-06** Pivô Duplo / Double Pivot | **LP-0010-07** Manivela / Crank Arm

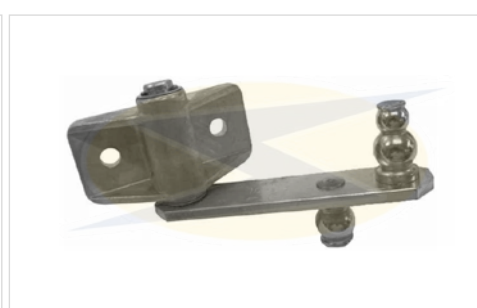
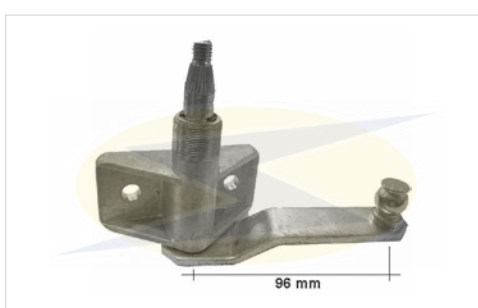

LP-0011

Conjunto Completo / Complete Part

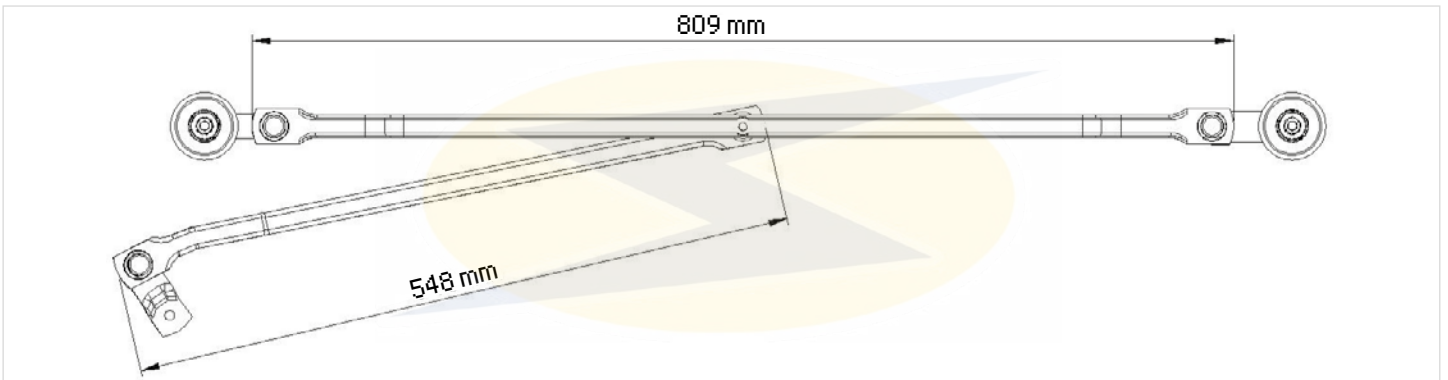
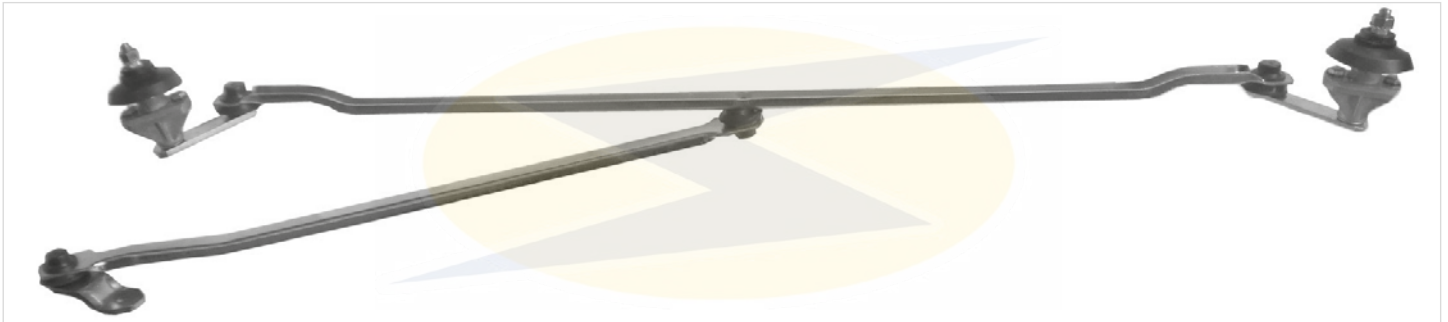

Aplicação / Application: MBB: 1218 BICUDO (1997→), 1618 SÉRIE L (1998→) - (LADO ESQUERDO DO MOTOR) / (LEFT SIDE MOTOR)
 LP-0011-05 TAMBÉM APLICA EM / ALSO APPLIES IN MBB: 712C, 914C (1998→), CARA CHATA (1997→) (LADO ESQUERDO DO MOTOR) / (LEFT SIDE MOTOR), SÉRIE L 1620 (L / LA / LK / LAK / LS / LB) (2001→)

LP-0011: Reparos | Repairs

LP-0011-01

Barra Longa / Long Arm

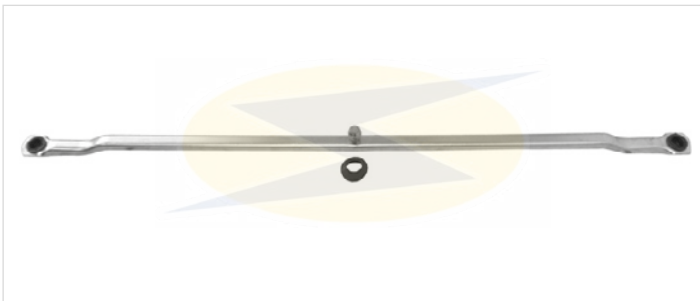

LP-0011-02

Barra Curta / Short Arm



LP-0011-03

Pivô Longo / Long Pivot

LP-0011-04

Pivô Curto / Short Pivot

LP-0011-05

Manivela / Crank Arm

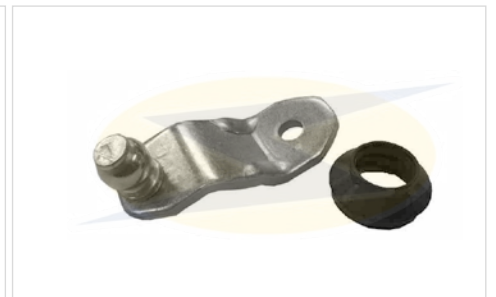
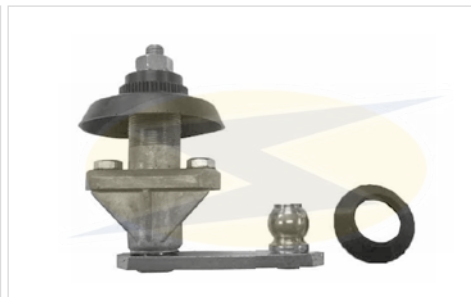
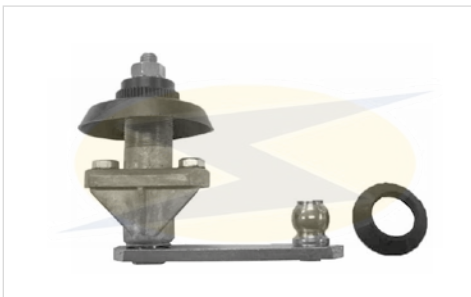

LP-0013

Conjunto Completo / Complete Part

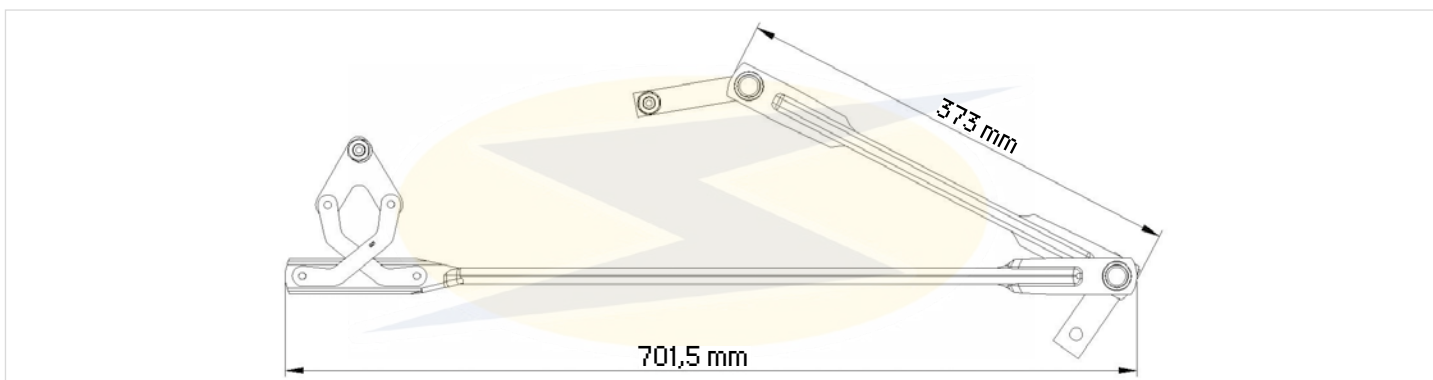
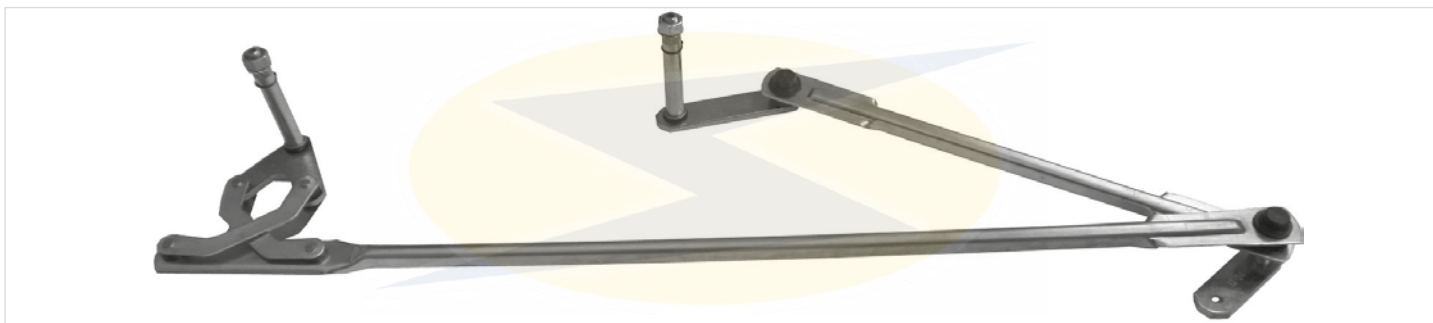

Aplicação / Application: VOLVO: NH12, FH12, FM 10, FM 12 (1999→)

LP-0013 : Reparos | Repairs

LP-0012-01

Barra Longa / Long Arm

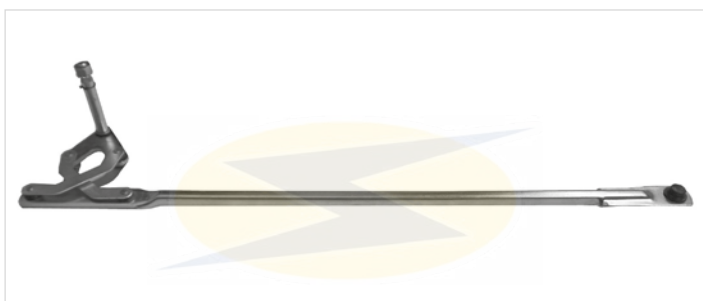

LP-0013-02

Barra Curta / Short Arm



LP-0013-03

Pivô / Pivot



LP-0013-04

Manivela / Crank Arm



LP-0015

Conjunto Completo / Complete Part

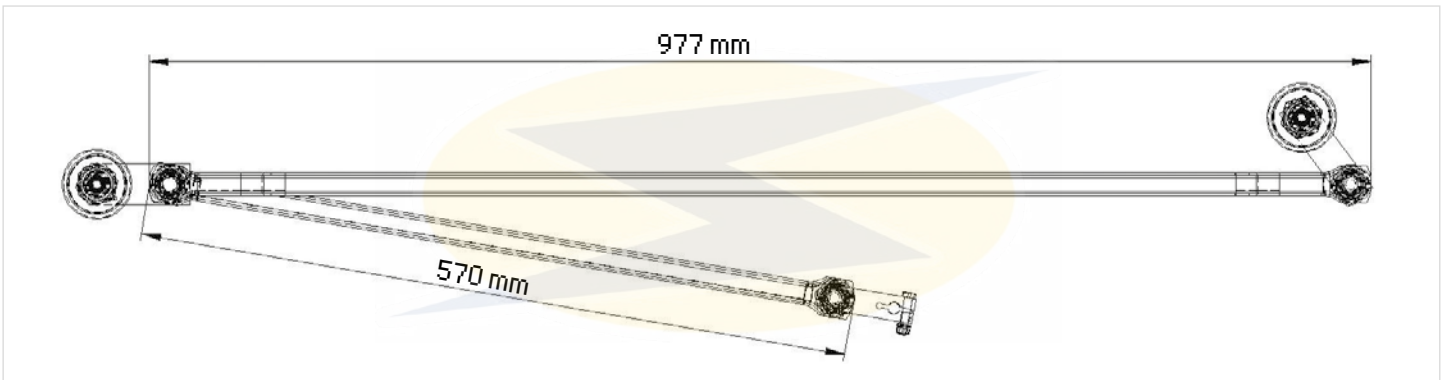
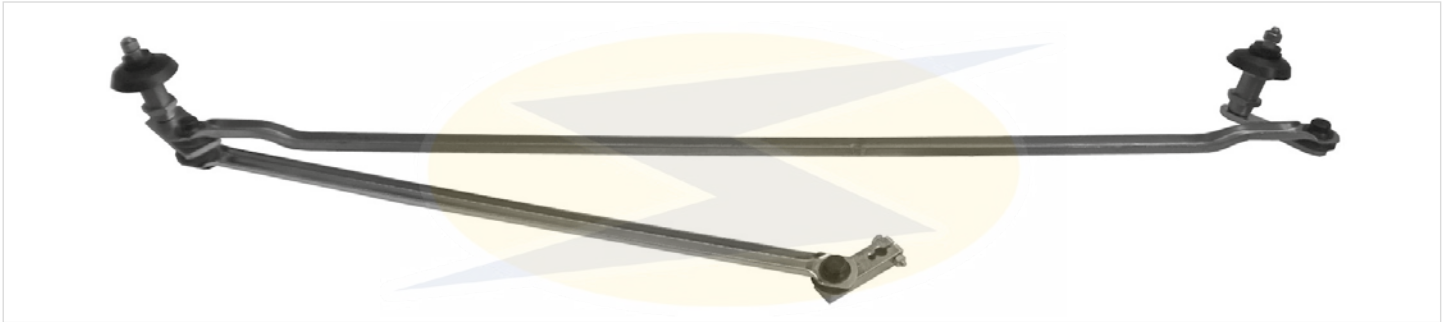

Aplicação / Application: **MBB:** 1935, 1941, SÉRIE L (1988→) - (MOTOR LADO DIREITO) / (RIGHT SIDE MOTOR)

LP-0015: Reparos | Repairs

LP-0015-01

Barra Longa / Long Arm

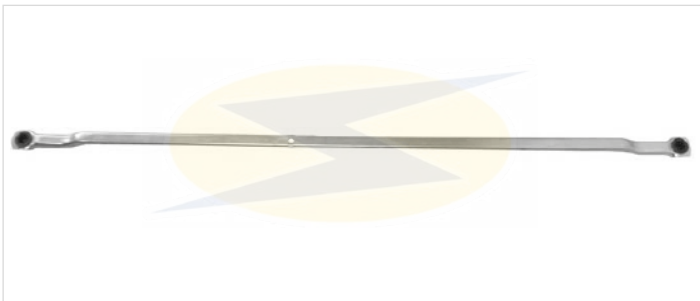

LP-0006-02

Barra Curta / Short Arm



LP-0006-03

Pivô Longo / Long Pivot

LP-0006-04

Pivô Curto / Short Pivot

LP-0006-05

Manivela / Crank Arm

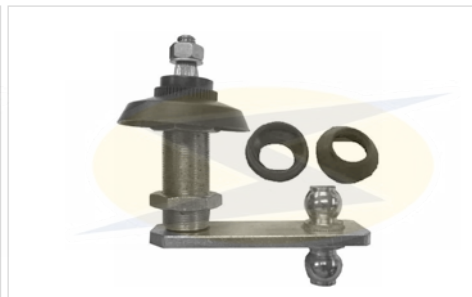

LP-0019 **Conjunto Completo / Complete Part**

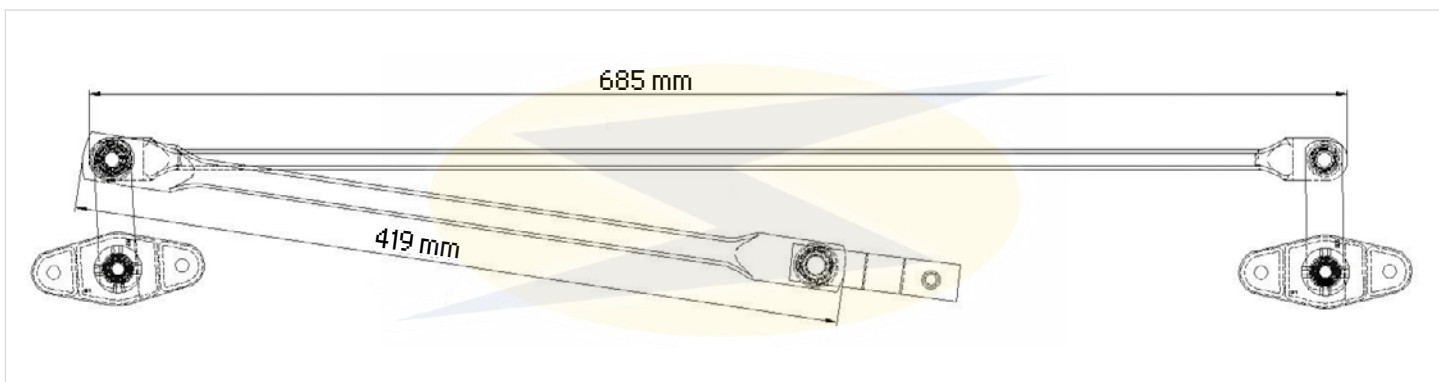
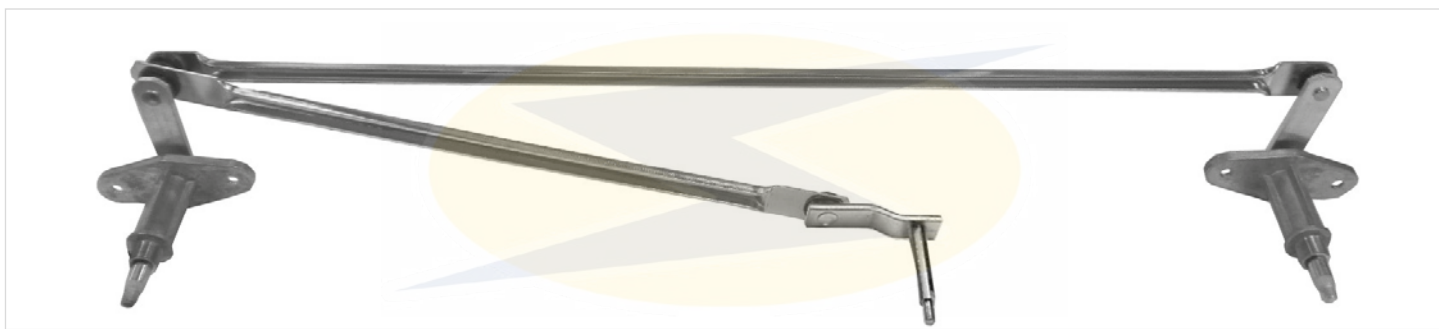

Aplicação / Application: VW: 6T, 7T (1982→1992), 11T Á 16T, 22T (1992→2000) MOTOR WAPSA

LP-0019: Reparos | Repairs

LP-0019-01 Barra Longa / Long Arm

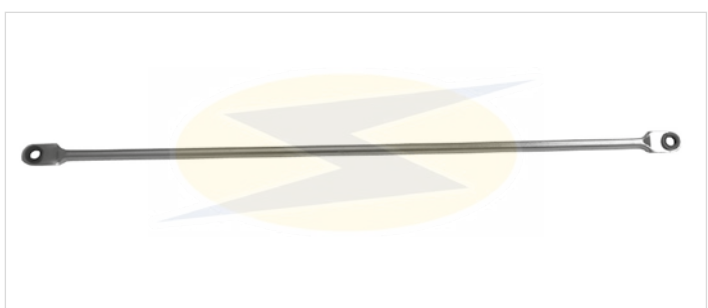

LP-0019-02 Barra Curta / Short Arm

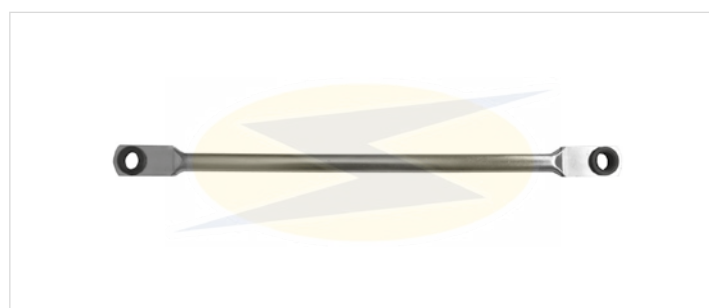

LP-0019-03 Pivô Direito / Right Pivot

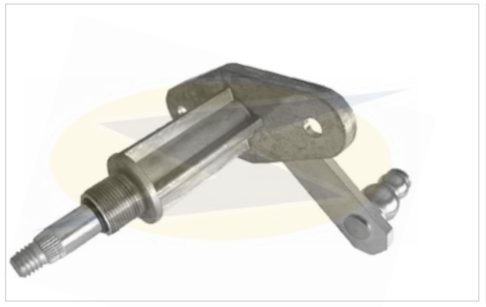

LP-0019-04 Pivô Esquerdo / Left Pivot

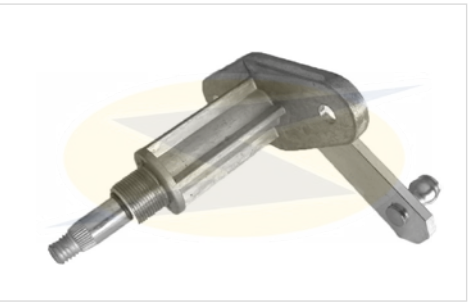

LP-0019-05 Manivela / Crank Arm



LP-0021

Conjunto Completo / Complete Part

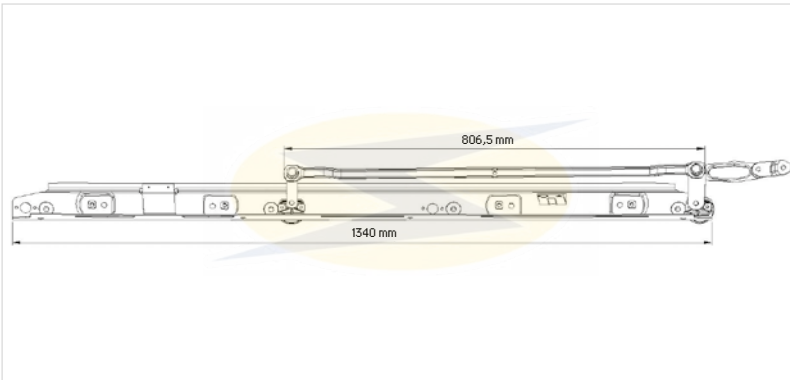

LP-0021 : Reparos | Repairs

LP-0021 SS Conjunto sem suporte / Part without Bracket Set



Aplicação / Application: MBB: 712C, 914C (1998→) - MOTOR LADO ESQUERDO / LEFT SIDE MOTOR

LP-0006-01 Barra Longa / Long Arm

LP-0021-02 Barra Curta / Short Arm

LP-0021-03 Pivô Duplo / Double Pivot

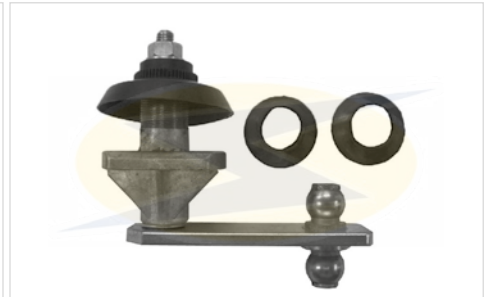

LP-0021-04 Pivô Curto / Short Pivot

LP-0011-05 Manivela / Crank Arm

LP-0021-06 Suporte do Conjunto / Bracket Set



LP-0022 **Conjunto Completo / Complete Part**

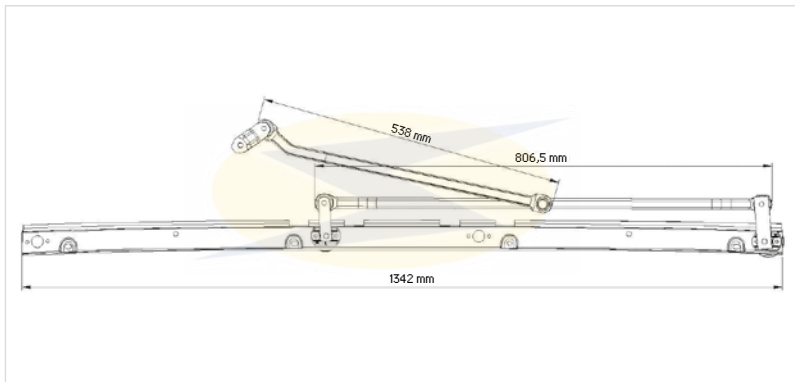
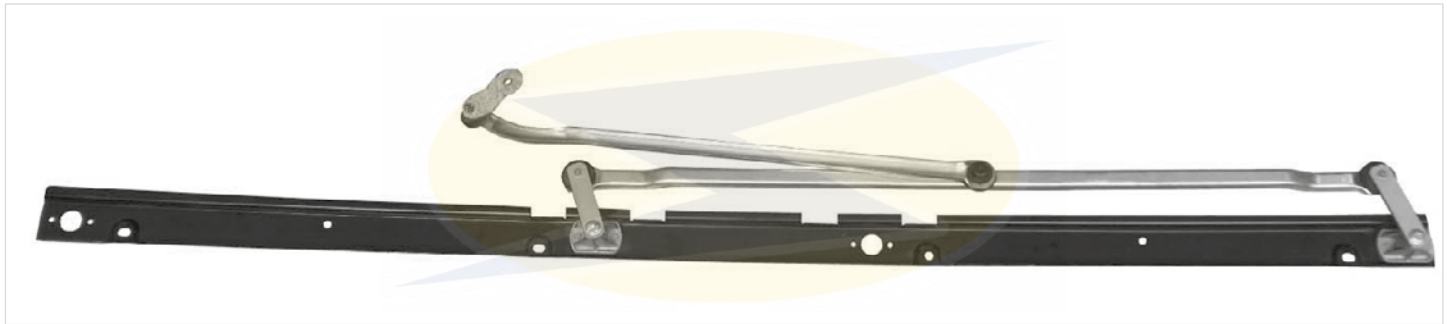

LP-0022 : Reparos | Repairs

LP-0022SS **Conjunto sem suporte / Part without Bracket Set**

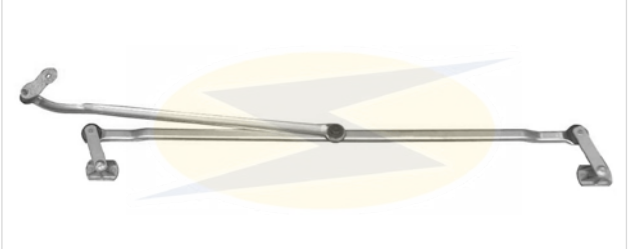

Aplicação / Application: **MBB:** 1618 SERIE L (1998→), 1620 (2001→) - MOTOR LADO DIREITO / **RIGHT SIDE MOTOR**

LP-0022: Reparos | Repairs

- LP-0006-01** Barra Longa / Long Arm
- LP-0022-02** Barra Curta / Short Arm
- LP-0002-03** Pivô Longo / Long Pivot

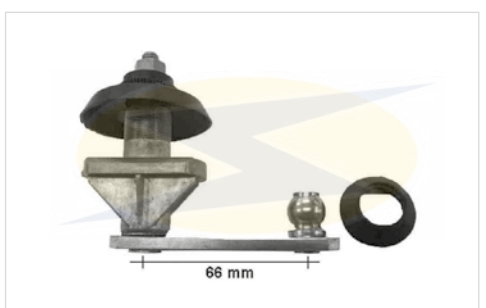

- LP-0002-04** Pivô Curto / Short Pivot
- LP-0022-05** Manivela / Crank Arm
- LP-0022-06** Suporte do Conjunto / Bracket Set

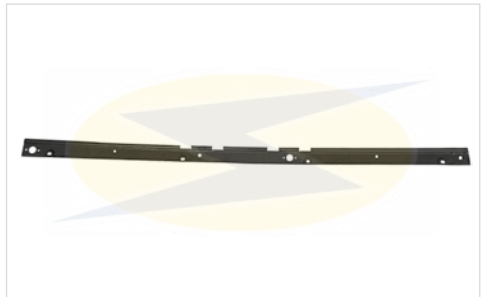
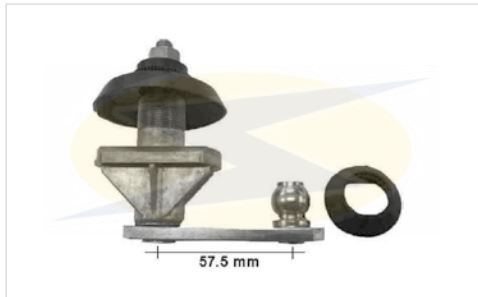

LP-0027

Conjunto Completo / Complete Part

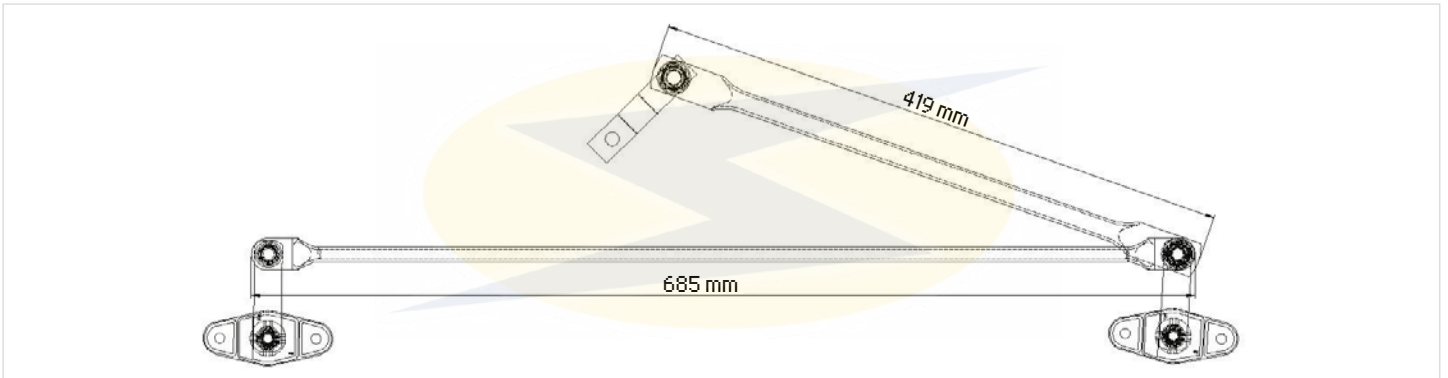
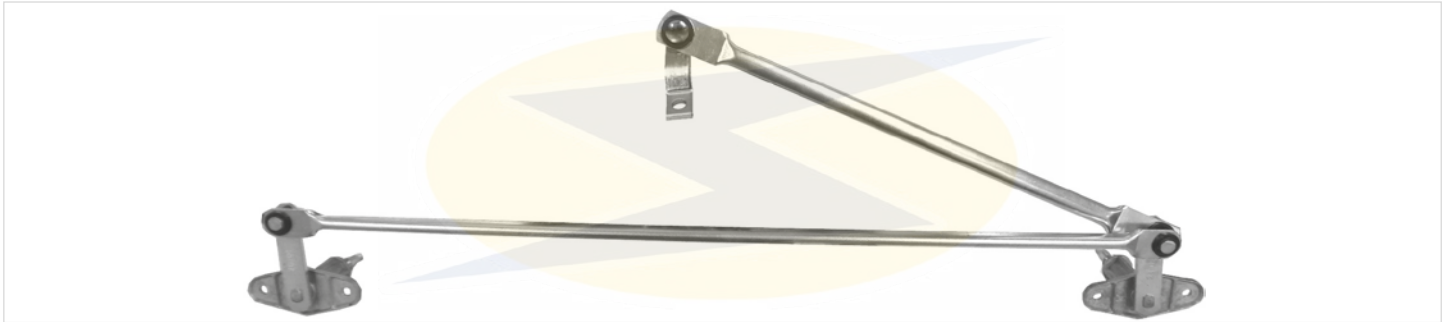

Aplicação / Application: VW: 6T, 7T (1982→1992), 11T Á 16T, 22T (1992→2000) MOTOR BOSCH

LP-0027: Reparos | Repairs

LP-0019-01

Barra Longa / Long Arm



LP-0019-02

Barra Curta / Short Arm



LP-0019-03 Pivô Direito / Right Pivot

LP-0019-04 Pivô Esquerdo / Left Pivot

LP-0027-05

Manivela / Crank Arm

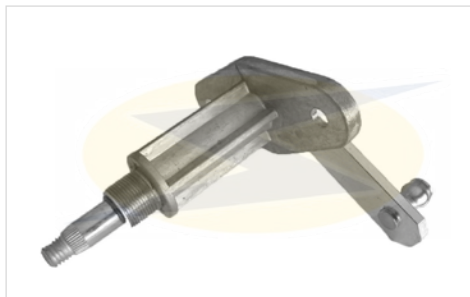

Legenda:

- LM:** Lado Motriz / Engine Side
- LC:** Lado Coletor / Commutator Side
- I:** Intermediária / Intermediate
- PLAN.:** Planetária / Planetary Gear

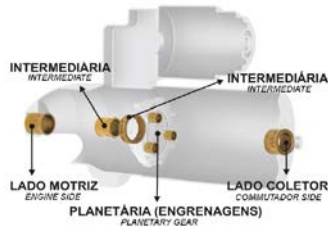

LM

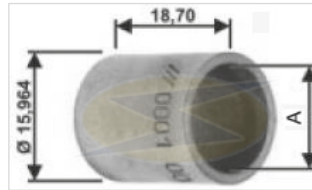

BC1-0001-00	STD	A = Ø 12,764
BC1-0001-02	2X	A = Ø 12,635
BC1-0001-03	3X	A = Ø 12,513

Aplicação / Application: FORD: F100, F350, F600

Observação / Note: CAIXA COM 10 PEÇAS / BOX WITH

10 PIECES

LM / LC

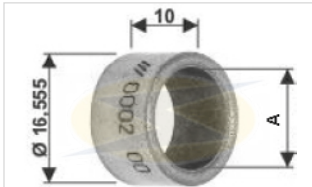

BC1-0002-00	STD	A = Ø 12,548
BC1-0002-02	2X	A = Ø 12,426

Aplicação / Application: FIAT, FORD, CHEVROLET-GM, PEUGEOT, VOLKSWAGEN: CAMINHÃO / TRUCK, DODGE, SCANIA

Observação / Note: CAIXA COM 10 PEÇAS / BOX WITH 10
PIECES. (BOSCH: JF)

LM

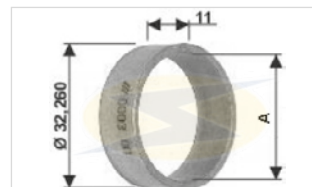

BC1-0003-00	STD	A = Ø 28,385
BC1-0003-02	2X	A = Ø 28,285

Aplicação / Application: VOLKSWAGEN: GOL, PARATI, SANTANA, LOGUS 1.8, 2.0, POINTER, GOLF GTI 2.0, FORD: FIESTA 1.4, ESCORT 1.6

Observação / Note: CAIXA COM 10 PEÇAS / BOX WITH

10 PIECES

LM

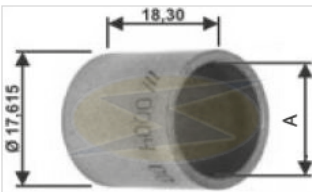

BC1-0004-00	STD	A = Ø 14,288
BC1-0004-02	2X	A = Ø 14,160
BC1-0004-03	3X	A = Ø 14,037

Aplicação / Application: AGRALE: TRATOR T4200, CBT: TRATOR 1000, FORD: CAMINHÃO DIESEL, TRATOR 8BR (PERKINS → 1971), MF-50, 55X, 65R, 65X, 235, 250, 265

Observação / Note: CAIXA COM 10 PEÇAS / BOX WITH

10 PIECES

LC

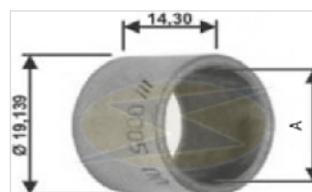

BC1-0005-00	STD	A = Ø 15,952
BC1-0005-02	2X	A = Ø 15,824
BC1-0005-03	3X	A = Ø 15,702

Aplicação / Application: AGRALE: TRATOR T4200, CBT: TRATOR 1000, FORD: CAMINHÃO DIESEL, TRATOR 8BR (PERKINS → 1971), MF-50, 55X, 65R, 65X, 235, 250, 265

Observação / Note: CAIXA COM 10 PEÇAS / BOX WITH

10 PIECES

LC

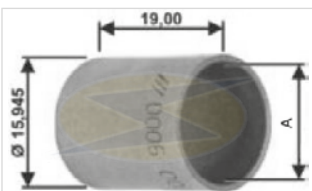

BC1-0006-00	STD	A = Ø 14,303
BC1-0006-02	2X	A = Ø 14,175
BC1-0006-03	3X	A = Ø 14,052

Aplicação / Application: CHEVROLET-GM: OPALA, CA-RAVAN 4 E 6CC, C10 6CC

Observação / Note: CAIXA COM 10 PEÇAS / BOX WITH

10 PIECES

LM / I

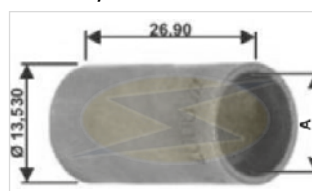

BC1-0007-00	STD	A = Ø 11,653
BC1-0007-02	2X	A = Ø 11,540

Aplicação / Application: FIAT: TIPO 1.6 / 2.0, UNO, FIORINO

Observação / Note: CAIXA COM 10 PEÇAS / BOX WITH

10 PIECES

LM / I

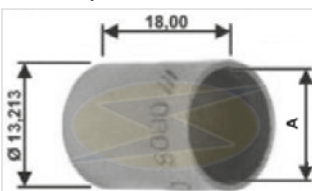

BC1-0008-00	STD	A = Ø 11,963
BC1-0008-02	2X	A = Ø 11,836
BC1-0008-03	3X	A = Ø 11,709

Aplicação / Application: CHEVROLET-GM: OPALA, CA-RAVAN 4 E 6CC, C10 6CC

Observação / Note: CAIXA COM 10 PEÇAS / BOX WITH 10 PIECES

LC

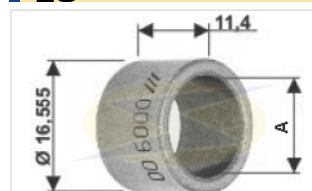

BC1-0009-00	STD	A = Ø 12,548
BC1-0009-02	2X	A = Ø 12,426
BC1-0009-03	3X	A = Ø 12,299

Aplicação / Application: VOLKSWAGEN: GOL, PASSAT, SANTANA, FIAT: 147, OGGI, FORD: CORCEL, PAMPA, ESCORT, CHEVROLET-GM: IPANEMA, KADET, MONZA

Observação / Note: CAIXA COM 10 PEÇAS / BOX WITH 10 PIECES

Legenda:

- LM:** Lado Motriz / Engine Side
- LC:** Lado Coletor / Commutator Side
- I:** Intermediária / Intermediate
- PLAN.:** Planetária / Planetary Gear

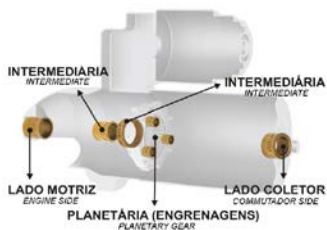

LM / LC

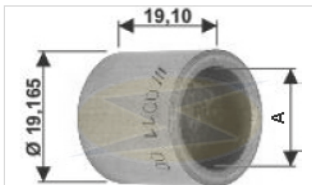

BC1-0011-00 STD A = Ø 14,428
BC1-0011-02 2K A = Ø 14,301

Aplicação / Application: **MBB, FORD, VOLKSWAGEN**

37MT E 42MT

Observação / Note: CAIXA COM 10 PEÇAS / BOX WITH 10
 PEÇES. (DELCO REMY: 37 MT / 42MT)

I

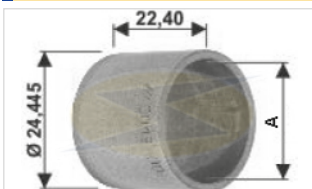

BC1-0013-00 STD A = Ø 21,325
BC1-0013-02 2K A = Ø 21,198

Aplicação / Application: **MBB, FORD, VOLKSWAGEN**

Observação / Note: CAIXA COM 10 PEÇAS / BOX WITH 10
 PEÇES. (DELCO REMY: 42MT)

LM / LC

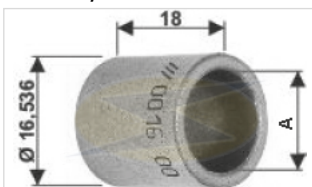

BC1-0016-00 STD A = Ø 12,522
BC1-0016-02 2K A = Ø 12,395
BC1-0016-03 3K A = Ø 12,268

Aplicação / Application: **CBT: TRATORES / TRACTORS**
 1105, 2105, 8240, CASE 960, POCLAIN, CLARK MB JD
 / JF - OM 352, JEEP, TOYOTA: BANDEIRANTE OM 352

Observação / Note: CAIXA COM 10 PEÇAS / BOX WITH

10 PEÇES. (BOSCH: JD / JF)

LM

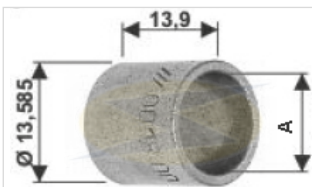

BC1-0018-00 STD A = Ø 11,048
BC1-0018-02 2K A = Ø 10,921
BC1-0018-03 3K A = Ø 10,794

Aplicação / Application: **VOLKSWAGEN: 1300, 1500,**
 1600, BRASILIA, SP2, VARIANT, KOMBI, FORD: AERO
 WILLYS, JEEP, RURAL, PICK-UP F75, MAVERICK 4, 6
 CIL.

Observação / Note: CAIXA COM 10 PEÇAS / BOX WITH 10 PEÇES

LM

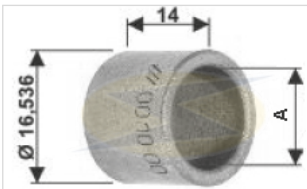

BC1-0010-00 STD A = Ø 12,522
BC1-0010-02 2K A = Ø 12,395

Aplicação / Application: **MOTORES ESTACIONÁRIOS**
 / STATIONARY ENGINES: AGRALE, CBT, CLARK, VALMET,
 CHEVROLET-GM, VOLKSWAGEN

Observação / Note: CAIXA COM 10 PEÇAS / BOX WITH
 10 PEÇES

LM

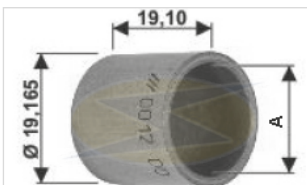

BC1-0012-00 STD A = Ø 16,002
BC1-0012-02 2K A = Ø 15,820

Aplicação / Application: **MBB, FORD, VOLKSWAGEN**

Observação / Note: CAIXA COM 10 PEÇAS / BOX WITH
 10 PEÇES. (DELCO REMY: 42MT)

I

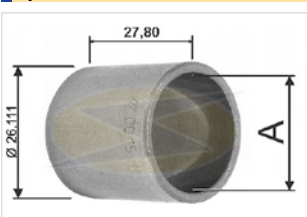

BC1-0015-00 STD A = Ø 22,187

Aplicação / Application: **KOMATSU: TRATORES, MBB:**
 MALVES COM, FIAT: FNM D9500, TRATOR

Observação / Note: CAIXA COM 6 PEÇAS / BOX WITH 6

PEÇES. (BOSCH)

I

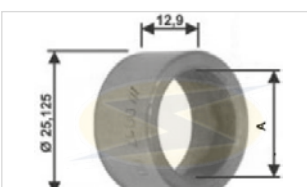

BC1-0017-00 STD A = Ø 19,113
BC1-0017-02 2K A = Ø 18,911
BC1-0017-03 3K A = Ø 18,834

Aplicação / Application: **MB: TODOS / ALL JD, MASSEY-**
-FERGUSON, TOYOTA, VALMET, YANMAR: MOTORES
 AE1, AB2

Observação / Note: CAIXA COM 10 PEÇAS / BOX WITH

10 PEÇES

LM

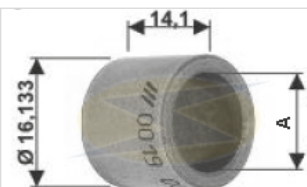

BC1-0019-00 STD A = Ø 12,063
BC1-0019-02 2K A = Ø 11,936
BC1-0019-03 3K A = Ø 11,809

Aplicação / Application: **CHEVROLET-GM: OPALA 2500,**
 CARAVAN 2500, CHEVETTE, CORCEL I / II, BELINA I / II,
 PAMPA, DEL-REY

Observação / Note: CAIXA COM 10 PEÇAS / BOX WITH

10 PEÇES

Legenda:

- LM:** Lado Motriz / Engine Side
- LC:** Lado Coletor / Commutator Side
- I:** Intermediária / Intermediate
- PLAN.:** Planetária / Planetary Gear

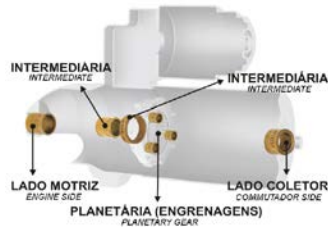

LM

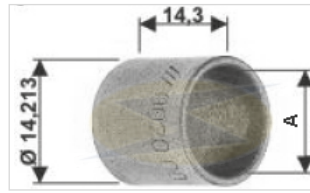

BC1-0020-00	STD	A = Ø 12,063
BC1-0020-02	2X	A = Ø 11,938
BC1-0020-03	3X	A = Ø 11,813

Aplicação / Application: FIAT, FORD, CHEVROLET-GM, VOLKSWAGEN, PEUGEOT, RENAULT

Observação / Note: CAIXA COM 10 PEÇAS / BOX WITH 10 PIECES

LM

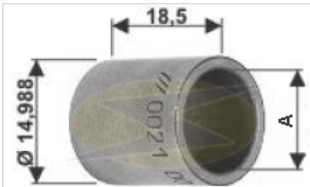

BC1-0021-00	STD	A = Ø 11,998
BC1-0021-02	2X	A = Ø 11,873

Aplicação / Application: FORD: GALAXIE, LANDAU, JEEP, RURAL, MAVERICK, KF: GUINDASTES / CRANE, HYSTER

Observação / Note: CAIXA COM 10 PEÇAS / BOX WITH 10 PIECES

LC

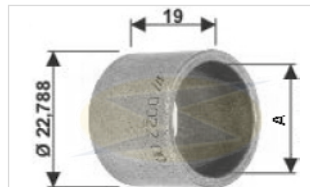

BC1-0022-00	STD	A = Ø 18,830
BC1-0022-02	2X	A = Ø 18,690
BC1-0022-03	3X	A = Ø 18,563

Aplicação / Application: CBT: CAMINHÕES / TRUCKS, FORD, CHEVROLET-GM, VOLKSWAGEN: C/ MOTOR / ENGINE PERKINS, FORD: F1000, F4000, AGRALE: TRATOR / TRACTOR T4200, CASE: 580

Observação / Note: CAIXA COM 10 PEÇAS / BOX WITH 10 PIECES

LM

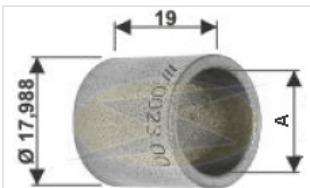

BC1-0023-00	STD	A = Ø 14,325
BC1-0023-02	2X	A = Ø 14,160
BC1-0023-03	3X	A = Ø 14,025

Aplicação / Application: CBT: CAMINHÕES, FORD, CHEVROLET-GM, VOLKSWAGEN C/ MOTOR / ENGINE PERKINS, MWM, VALMET: EIXO GROSSO / THICK SHAFT

Observação / Note: CAIXA COM 10 PEÇAS / BOX WITH 10 PIECES

LC

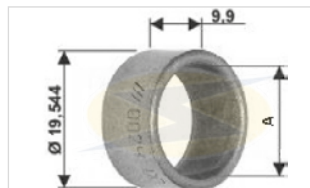

BC1-0024-00	STD	A = Ø 15,748
BC1-0024-02	2X	A = Ø 15,621
BC1-0024-03	3X	A = Ø 15,494

Aplicação / Application: MB, CBT: TRATORES / TRACTORS, AGRALE: MOTORES MWM DIESEL / MWM DIESEL ENGINES

Observação / Note: CAIXA COM 10 PEÇAS / BOX WITH 10 PIECES (BOSCH: JF / JD)

I

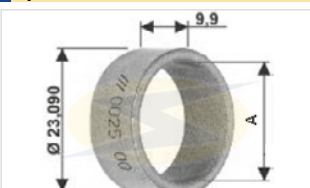

BC1-0025-00	STD	A = Ø 19,101
BC1-0025-02	2X	A = Ø 18,974
BC1-0025-03	3X	A = Ø 18,847

Aplicação / Application: MB, CBT: TRATORES / TRACTORS, AGRALE: MOTORES MWM DIESEL / MWM DIESEL ENGINES

Observação / Note: CAIXA COM 10 PEÇAS / BOX WITH 10 PIECES (BOSCH: JF / JD)

LC

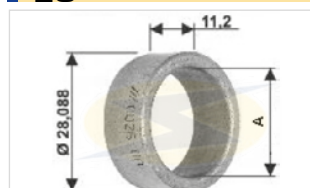

BC1-0026-00	STD	A = Ø 22,128
BC1-0026-02	2X	A = Ø 22,001
BC1-0026-03	3X	A = Ø 21,874

Aplicação / Application: VOLVO: N10, FNM, MBB, SSB

Observação / Note: CAIXA COM 10 PEÇAS / BOX WITH 10 PIECES (BOSCH KB)

LM

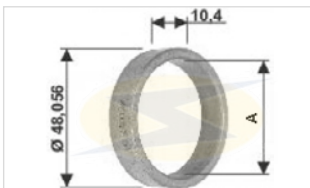

BC1-0027-00	STD	A = Ø 40,093
BC1-0027-02	2X	A = Ø 39,966
BC1-0027-03	3X	A = Ø 39,839

Aplicação / Application: VOLVO: N10, FNM, MBB, SSB

Observação / Note: CAIXA COM 8 PEÇAS / BOX WITH 8 PIECES (BOSCH: KB)

LM

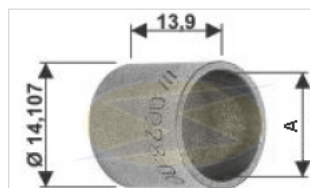

BC1-0028-00	STD	A = Ø 12,088
BC1-0028-02	2X	A = Ø 11,963
BC1-0028-03	3X	A = Ø 11,898

Aplicação / Application: FIAT: 147 (TODOS / ALL), VOLKSWAGEN: PASSAT, GOL, VOYAGE (10/1981-→)

Observação / Note: CAIXA COM 10 PEÇAS / BOX WITH 10 PIECES

Legenda:

- LM:** Lado Motriz / Engine Side
- LC:** Lado Coletor / Commutator Side
- I:** Intermediária / Intermediate
- PLAN.:** Planetária / Planetary Gear

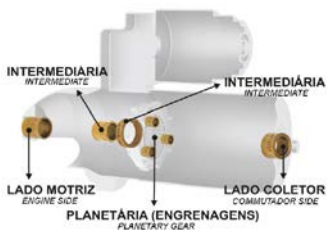

LC



BC1-0029-00	STD	A = Ø 11,998
BC1-0029-02	2K	A = Ø 11,873
BC1-0029-03	3K	A = Ø 11,798

Aplicação / Application: VOLKSWAGEN: KOMBI, PAS-SAT, GOL, VOYAGE E SEDAN (10/1981→)

Observação / Note: CAIXA COM 10 PEÇAS / BOX WITH

10 PIECES

LM

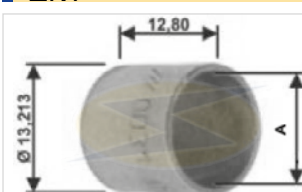

BC1-0031-00	STD	A = Ø 11,963
BC1-0031-02	2K	A = Ø 11,836

Aplicação / Application: CHEVROLET-GM: CARAVAN E OPALA (→1982)

Observação / Note: CAIXA COM 10 PEÇAS / BOX WITH

10 PIECES

I

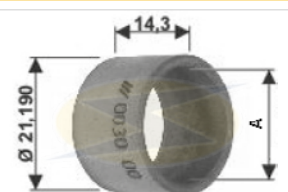

BC1-0030-00	STD	A = Ø 17,903
BC1-0030-02	2K	A = Ø 17,781

Aplicação / Application: VOLKSWAGEN: KOMBI DIE-SEL, PASSAT, GOL, VOYAGE, SEDAN (10/1981→), FIAT: 147 (TODOS / ALL)

Observação / Note: CAIXA COM 10 PEÇAS / BOX WITH

10 PIECES

LM

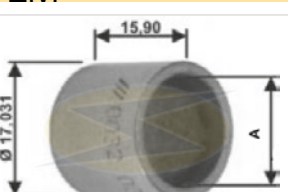

BC1-0032-00	STD	A = Ø 14,059
BC1-0032-02	2K	A = Ø 13,945

Aplicação / Application: DELCO: 28 MT

Observação / Note: CAIXA COM 10 PEÇAS / BOX WITH

10 PIECES

LM

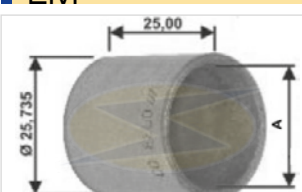

BC1-0033-00	STD	A = Ø 22,615
BC1-0033-02	2K	A = Ø 22,488

Aplicação / Application: DELCO: 37MT, MBB: COM MOTOR BR-400 (12 E 24V), FORD: CUMMINS SERIE C, VOLKSWAGEN

Observação / Note: CAIXA COM 10 PEÇAS / BOX WITH

10 PIECES

LM

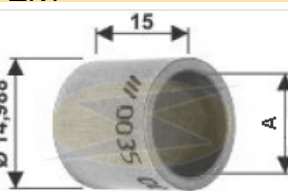

BC1-0035-00	STD	A = Ø 11,998
BC1-0035-02	2K	A = Ø 11,871

Aplicação / Application: DODGE: 1800, WILLYS / FORD: RURAL, JEEP, CLARK: EMPILHADEIRA / FORKLIFT

Observação / Note: CAIXA COM 10 PEÇAS / BOX WITH

10 PIECES

LC

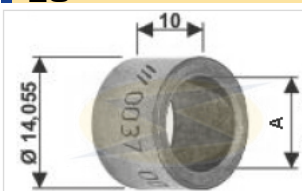

BC1-0037-00	STD	A = Ø 10,048
BC1-0037-02	2K	A = Ø 9,943

Aplicação / Application: VOLKSWAGEN: GOL MI E BO-LINHA, CHEVROLET-GM: CORSA, OMEGA, VECTRA, FORD: ESCORT

Observação / Note: CAIXA COM 10 PEÇAS / BOX WITH

10 PIECES

LC

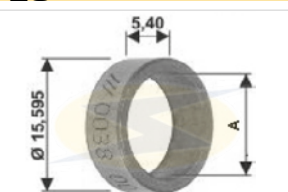

BC1-0038-00	STD	A = Ø 12,095
BC1-0038-02	2K	A = Ø 11,970

Aplicação / Application: FORD: FIESTA TURBO 1.0, 1.4, VERONA C/ MOTOR AUDI 2.0 (827) / AUDI ENGINE, ES-CORT ZETEC, FIAT: PALIO TURBO 1.0 / 1.5 / 1.6

Observação / Note: CAIXA COM 10 PEÇAS / BOX WITH

10 PIECES

LM / I

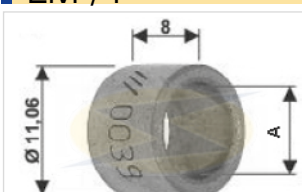

BC1-0039-00	STD	A = Ø 8,100
BC1-0039-02	2K	A = Ø 7,970

Aplicação / Application: FORD: ECOSPORT, KA, FIESTA 1.0 / 1.6, ESCORT 1.6, VERONA, SPRINTER, F250, FIAT: PALIO, SIENA E STRADA 1.0, 1.4 8V FIRE

Observação / Note: CAIXA COM 10 PEÇAS / BOX WITH

10 PIECES

LM

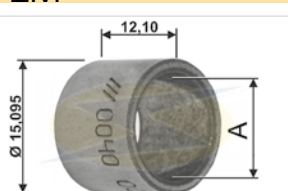

BC1-0040-00	STD	A = Ø 12,048
BC1-0040-02	2K	A = Ø 11,970

Aplicação / Application: FORD: ESCORT, VERSAILLES, PAMPA, VOLKSWAGEN: GOL, VOYAGE, PARATI, SAVEI-RO, FIAT: UNO 1.6 (1994→)

Observação / Note: CAIXA COM 10 PEÇAS / BOX WITH

10 PIECES

LC

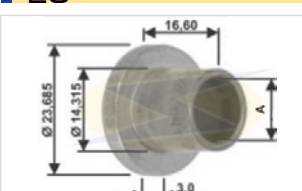

BC1-0041-00	STD	A = Ø 11,138
--------------------	------------	--------------

Aplicação / Application: FIAT: UNO (1994→), VERSAIL-LES, PAMPA (1992→), VOLKSWAGEN: GOL MI, GOL II, VOYAGE, PARATI COM MOTOR AP (1992→)

Observação / Note: CAIXA COM 10 PEÇAS / BOX WITH

10 PIECES

Legenda:

- LM:** Lado Motriz / Engine Side
- LC:** Lado Coletor / Commutator Side
- I:** Intermediária / Intermediate
- PLAN.:** Planetária / Planetary Gear

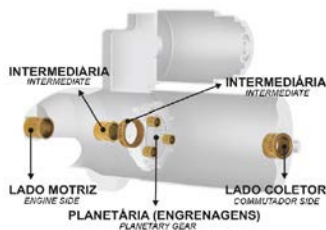

LC

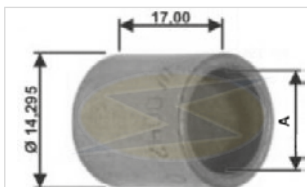

BC1-0042-00 STD A = Ø 11,153
BC1-0042-02 2X A = Ø 11,026

Aplicação / Application: FIAT: UNO 1.6 (1994→), FORD: ESCORT GUARUJÁ, HOBBY, L E GL CHT 1.6 (1994→), VOLKSWAGEN: GOL, VOYAGE, SAVEIRO

Observação / Note: CAIXA COM 10 PEÇAS / BOX WITH 10 PIECES

I

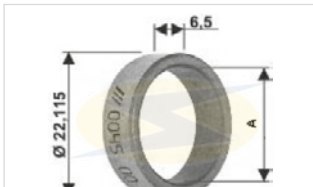

BC1-0045-00 STD A = Ø 18,015

Aplicação / Application: FORD: ESCORT, VERONA MOTOR ZETEC / ZETEC ENGINE, F250, SPRINTER

Observação / Note: CAIXA COM 10 PEÇAS / BOX WITH 10 PIECES

LM / LC / I

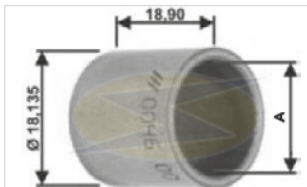

BC1-0046-00 STD A = Ø 15,063
BC1-0046-02 2X A = Ø 14,940
BC1-0046-03 3X A = Ø 14,785

Aplicação / Application: FORD: F1000, F4000 MWM 4CC, CHEVROLET-GM: D20, TRAFFIC, JOHN DEERE

Observação / Note: CAIXA COM 10 PEÇAS / BOX WITH 10 PIECES

LM

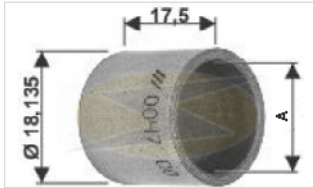

BC1-0047-00 STD A = Ø 15,063
BC1-0047-02 2X A = Ø 14,940

Aplicação / Application: CHEVROLET-GM: D20, TRAFIC, FORD: F1000, F4000 MWM 4CC, JOHN DEERE

Observação / Note: CAIXA COM 10 PEÇAS / BOX WITH 10 PIECES

LM / LC

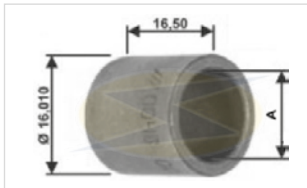

BC1-0048-00 STD A = Ø 12,010
BC1-0048-02 2X A = Ø 11,883

Aplicação / Application: BMW, FIAT: TIPO 1.6 / 2.0, SPAZIO, UNO, FIORINO, PEUGEOT

Observação / Note: CAIXA COM 10 PEÇAS / BOX WITH 10 PIECES

LM / LC

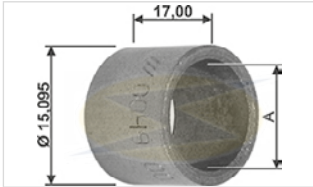

BC1-0049-00 STD A = Ø 12,088

Aplicação / Application: FORD: F300, F350, F600, F1000 COM MOTOR EMAX, GM: BLAZER, S10, SILVERADO, CAMINHÃO C400

Observação / Note: CAIXA COM 10 PEÇAS / BOX WITH 10 PIECES

LC

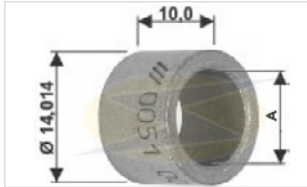

BC1-0051-00 STD A = Ø 10,060
BC1-0051-02 2X A = Ø 9,933

Aplicação / Application: FIAT: PALIO WEEKEND, SIENA, STRADA, TIPO, TEMPRA

Observação / Note: CAIXA COM 10 PEÇAS / BOX WITH 10 PIECES

LM

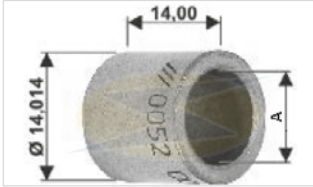

BC1-0052-00 STD A = Ø 10,060
BC1-0052-02 2X A = Ø 9,933
BC1-0052-03 3X A = Ø 9,806

Aplicação / Application: FIAT: PALIO WEEKEND, SIENA, STRADA, TIPO, TEMPRA

Observação / Note: CAIXA COM 10 PEÇAS / BOX WITH 10 PIECES

LM / I

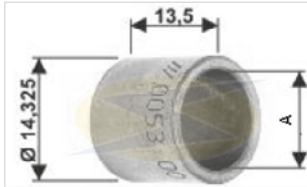

BC1-0053-00 STD A = Ø 11,215

Aplicação / Application: FIAT: FIORINO, UNO, TIPO, PREMIO, ELBA, MB: OF1316, OH1316, OH1318, OH1320, O371, OF215, OF1315

Observação / Note: CAIXA COM 10 PEÇAS / BOX WITH 10 PIECES

LM

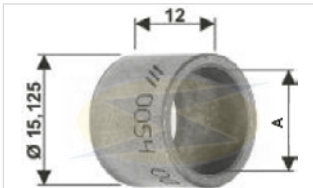

BC1-0054-00 STD A = Ø 12,080

Aplicação / Application: IVECO, MASSEY FERGUSON: TRATORES / TRACTORS

Observação / Note: CAIXA COM 10 PEÇAS / BOX WITH 10 PIECES

LM

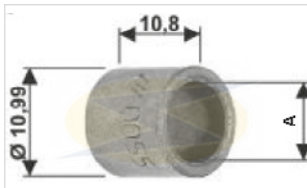

BC1-0055-00 STD A = Ø 8,00

Aplicação / Application: VOLKSWAGEN: GOL (BOLA), SANTANA, SAVEIRO, PARATI

Observação / Note: CAIXA COM 10 PEÇAS / BOX WITH 10 PIECES

Legenda:

LM: Lado Motriz / Engine Side

LC: Lado Coletor / Commutator Side

I: Intermediária / Intermediate

PLAN.: Planetária / Planetary Gear

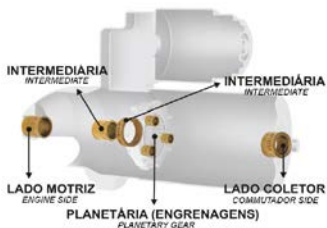

LC

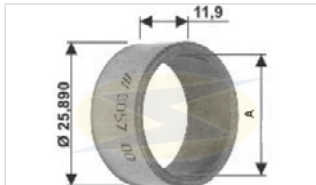

BC1-0057-00 STD A = Ø 21,840

Aplicação / Application: VOLKSWAGEN: CAMINHÕES
/ TRUCKS 24V
(PRESTOLITE M100R), MWM: MOTORES DE PARTIDA
/ STARTER ENGINES M100R 12 E 24V

Observação / Note: CAIXA COM 10 PEÇAS / BOX WITH 10 PIECES

LM

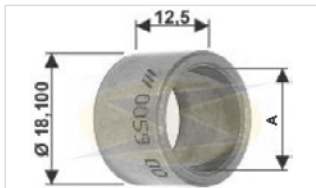

BC1-0059-00 STD A = Ø 14,100

Aplicação / Application: FORD: CARGO, MERCEDES-BENZ: SPRINTER, MASSEY FERGUSON, IVECO

Observação / Note: CAIXA COM 10 PEÇAS / BOX WITH 10 PIECES

LC

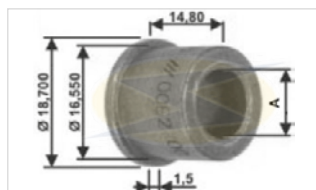

BC1-0062-00 STD A = Ø 10,050

Aplicação / Application: CHEVROLET-GM: BLAZER, FORD: F-250, F-1000, FIAT: DUCATO 2.8T INTERCOOLER, JEEP: GRAND CHEROKEE, DODGE: DAKOTA, MBB: SPRINTER, IVECO: DAILY

Observação / Note: CAIXA COM 10 PEÇAS / BOX WITH 10 PIECES

PLAN.

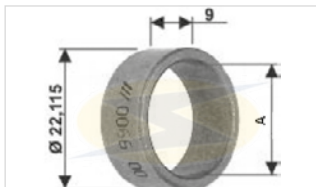

BC1-0066-00 STD A = Ø 18,015

Aplicação / Application: FIAT: TEMPRA, TIPO, CHEVROLET-GM: OMEGA, SUPREMA, VOLKSWAGEN: GOLF 1.8, PASSAT 2.0, AUDI, ALFA ROMEO, CHRYSLER

Observação / Note: CAIXA COM 10 PEÇAS / BOX WITH 10

PIECES. UNIFAP: PLANETÁRIA 11.307

LM

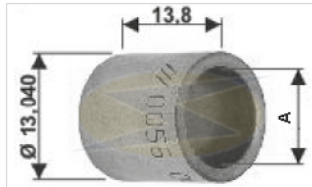

BC1-0056-00 STD A = Ø 10,050

Aplicação / Application: VOLKSWAGEN: CAMINHÕES
/ TRUCKS 24V

(PRESTOLITE M100R), MWM: MOTORES DE PARTIDA
/ STARTER ENGINES M100R 12 E 24V

Observação / Note: CAIXA COM 10 PEÇAS / BOX WITH 10 PIECES

I

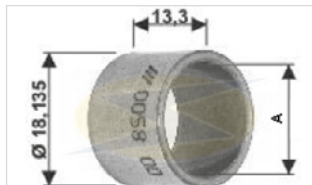

BC1-0058-00 STD A = Ø 15,063

Aplicação / Application: VOLKSWAGEN: CAMINHÕES
/ TRUCKS 24V
(PRESTOLITE M100R), MWM: MOTORES DE PARTIDA
/ STARTER ENGINES M100R 12 E 24V

Observação / Note: CAIXA COM 10 PEÇAS / BOX WITH 10 PIECES

I

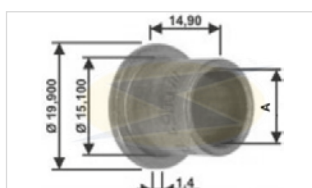

BC1-0061-00 STD A = Ø 12,070

Aplicação / Application: MERCEDES-BENZ: SPRINTER 310D, 312D, 412D, FIAT: DUCATO, FORD: F-250, PICK-UP DIESEL C/ MAXION

Observação / Note: CAIXA COM 10 PEÇAS / BOX WITH 10 PIECES

PLAN. / LC

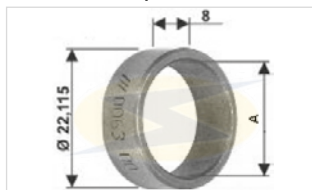

BC1-0063-00 STD A = Ø 18,015

BC1-0063-02 2K A = Ø 17,880

Aplicação / Application: FORD, GM, LAND ROVER, MASSEY FERGUSON

Observação / Note: CAIXA COM 10 PEÇAS / BOX WITH 10 PIECES. UNIFAP: PLANETÁRIAS 11.025, 11.059, 11.104, 12.149, 12.212, 12.219, 12.221, 12.222

I

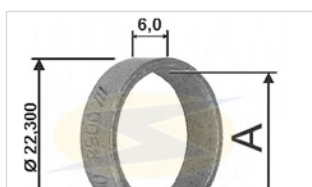

BC1-0068-00 STD A = Ø 19,030

Aplicação / Application: FORD: FIESTA, FOCUS, KA, MONDEO, RANGER

Observação / Note: CAIXA COM 10 PEÇAS / BOX WITH 10 PIECES.

Legenda:

- LM:** Lado Motriz / Engine Side
- LC:** Lado Coletor / Commutador Side
- I:** Intermediária / Intermediate
- PLAN.:** Planetária / Planetary Gear

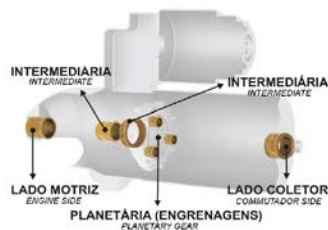

PLAN.

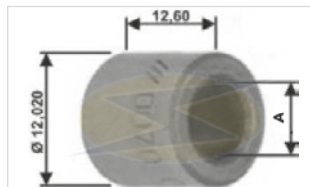

BC1-0070-00 STD A = Ø 7,040

Aplicação / Application: FORD: ESCORT, FIESTA, KA

Observação / Note: CAIXA COM 10 PEÇAS / BOX WITH

10 PIECES

PLAN. / LC

BC1-0071-00 STD A = Ø 8,02

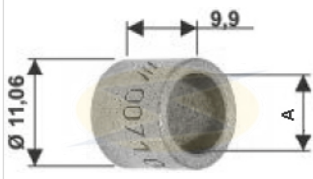

Aplicação / Application: MERCEDES-BENZ: SÉRIE: 7T / 9T / 12T / 14T / 16T / 24T / O

Observação / Note: CAIXA COM 10 PEÇAS / BOX WITH 10 PIECES.

UNIFAP: PLANETÁRIAS: 11.003, 11.010, 11.015

PLAN. / I

BC1-0072-00 STD A = Ø 7,040

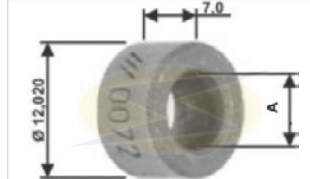

Aplicação / Application: FORD: FIESTA TURBO, ESCORT, VERONA (ZETEC), F-250, MERCEDES-BENZ: SPRINTER, FIAT: PALIO 1.0 TURBO, 1.5 / 1.6

Observação / Note: CAIXA COM 10 PEÇAS / BOX WITH 10

PIECES. UNIFAP: PLANETÁRIA 14.368

Plan

BC1-0073-00 STD A = Ø 5,015

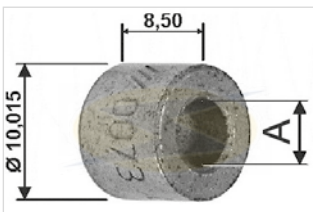

Aplicação / Application: MERCEDES-BENZ, RENAULT: LAGUNA 2.0, CHRYSLER: DODGE DAKOTA

Observação / Note: CAIXA COM 10 PEÇAS / BOX WITH 10

PIECES. UNIFAP: PLANETÁRIAS: 11.059, 11.161

PLAN. / I

BC1-0074-00 STD A = Ø 18,015

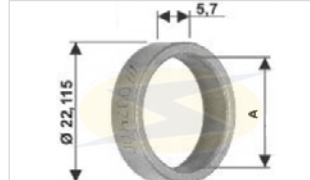

Aplicação / Application: VEÍCULOS RENAULT MOTOR VALEO D6RA133

Observação / Note: CAIXA COM 10 PEÇAS / BOX WITH

10 PIECES. UNIFAP: PLANETÁRIAS 11.010, 11.015, 11.018, 11.019

PLAN.

BC1-0075-00 STD A = Ø 6,020

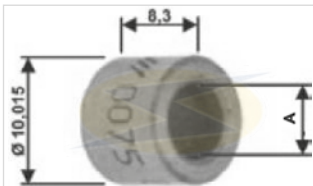

Aplicação / Application: CHEVROLET-GM: ASTRA, BLAZER, VECTRA, FORD: ESCORT, FIESTA, KA, FIAT: PALIO, VOLKSWAGEN: GOL, PARATI, SAVEIRO, GOLF

Observação / Note: CAIXA COM 10 PEÇAS / BOX WITH 10

PIECES. UNIFAP: PLAN. 11.010, 11.111, 13.119, 14.368

PLAN.

BC1-0076-00 STD A = Ø 6,020

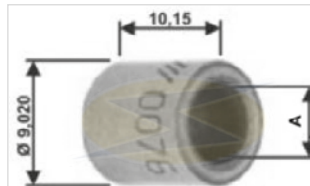

Aplicação / Application: AGRALE, GM, CUMMINS, FORD, JOHN DEERE, MASSEY-FERGUSON, MAXION, MB, PERKINS, PEUGEOT, VW, LAND ROVER

Observação / Note: CAIXA COM 10 PEÇAS / BOX WITH

10 PIECES. MOTOR DE PARTIDA: PRESTOLITE M93R, DELCO: PG150S

UNIFAP: PLAN. 11.003, 12.147, 14.150, 14.890, 14.910

PLAN.

BC1-0079-00 STD A = Ø 10,044

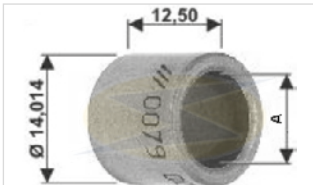

Aplicação / Application: CHEVROLET-GM: BLAZER, S10 VORTEC V6 4.3

Observação / Note: CAIXA COM 10 PEÇAS / BOX WITH

10 PIECES. UNIFAP: PLANETÁRIA 14.890

PLAN.

BC1-0080-00 STD A = Ø 6,020

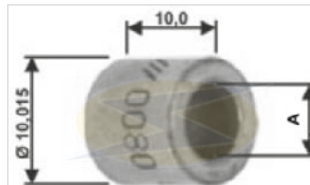

Aplicação / Application: FIAT: DUCATO, FORD: F-250, IVECO: DAILY 12 8140

Observação / Note: CAIXA COM 10 PEÇAS / BOX WITH

10 PIECES

PLAN.

BC1-0081-00 STD A = Ø 18,015

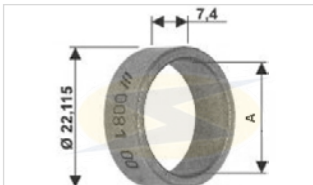

Aplicação / Application: CHEVROLET-GM: ASTRA, BLAZER, S10, VECTRA, FORD: F250 MWM 4.2 6CC, FIAT, VOLKSWAGEN

Observação / Note: CAIXA COM 10 PEÇAS / BOX WITH 10

PIECES. UNIFAP: PLANETÁRIAS: 11.010, 11.056, 11.067, 11.073, 11.090, 11.590

Plan

BC1-0082-00 STD A = Ø 5,060

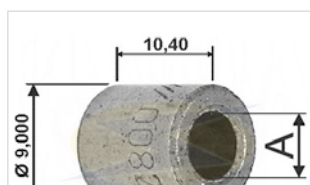

Aplicação / Application: MERCEDES-BENZ: 180 D (OM616), SPRINTER 310D, 312D, 412D (OM014 LA E OM014 A)

Observação / Note: CAIXA COM 10 PEÇAS / BOX WITH 10

PIECES. PLANETÁRIAS (SUB-ROLETE ENGENHAGENS)

Legenda:

- LM:** Lado Motriz / Engine Side
- LC:** Lado Coletor / Commutator Side
- I:** Intermediária / Intermediate
- PLAN.:** Planetária / Planetary Gear

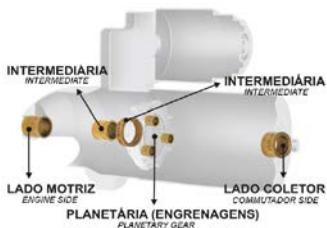

BC1-0084-00 STD A = Ø 26,130

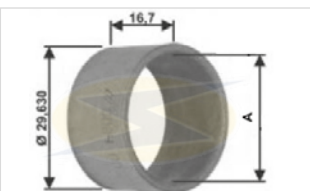

Aplicação / Application: FORD: F-100 6CC (1970→1977), JOHN DEERE, MASSEY FERGUSON,

MBB

Observação / Note: CAIXA COM 5 PEÇAS / BOX WITH 5 PIECES

BC1-0086-00 STD A = Ø 8,465

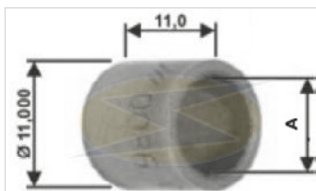

Aplicação / Application: FIAT: TEMPRA, TIPO, UNO, PALIO, SIENA, FORD: VERSAILLES, COURIER, ESCORT, FIESTA, GM: ASTRA, OMEGA, VECTRA, CORSA, VW: FUSCA, KOMBI, GOL, PASSAT, VOYAGE

Observação / Note: CAIXA COM 10 PEÇAS / BOX WITH 10 PIECES

LM

BC1-0087-00 STD A = Ø 22,115

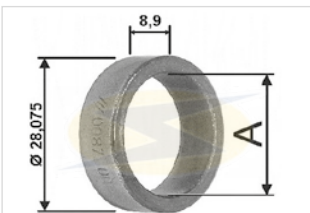

Aplicação / Application: FIAT: C/ MOTORES SOHC 1.8 8 E 16V, CHEVROLET-GM: C/ MOTORES DA FAMÍLIA 1 E 2. BLAZER E S-10 V6

Observação / Note: CAIXA COM 10 PEÇAS / BOX WITH 10 PIECES. (DELCO REMY PG-260D)

LM

BC1-0088-00 STD A = Ø 12,040

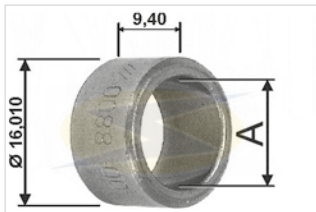

Aplicação / Application: FORD: MONDEO, F250 E RANGER, CHEVROLET-GM: S10, BLAZER, TOYOTA: HILUX, MBB: SPRINTER, IVECO: 35.10 E 49.10

Observação / Note: CAIXA COM 10 PEÇAS / BOX WITH 10 PIECES. (BOSCH EV)

I

BC1-0091-00 STD A = Ø 21,920

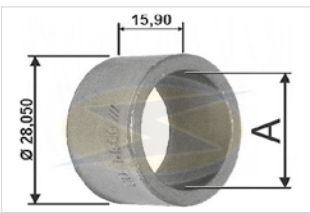

Aplicação / Application: FORD: CARGO 1722 TURBO C/ MOTOR CUMMINS 6BT59L, MBB: CAMINHÕES, SCANIA, VOLKSWAGEN

Observação / Note: CAIXA COM 10 PEÇAS / BOX WITH 10 PIECES (BOSCH JE)

LM / LC

BC1-0092-00 STD A = Ø 15,900

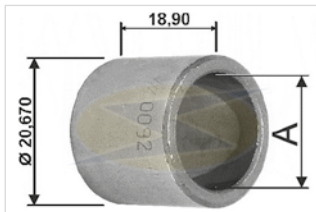

Aplicação / Application: FORD: CARGO 1722 TURBO C/ MOTOR CUMMINS 6BT59L, MBB: CAMINHÕES, SCANIA, VOLKSWAGEN

Observação / Note: CAIXA COM 10 PEÇAS / BOX WITH 10

PIECES. (BOSCH JE)

I

BC1-0093-00 STD A = Ø 8,100

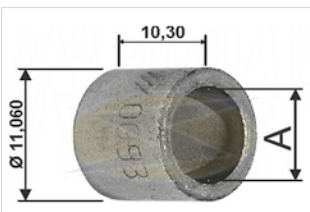

Aplicação / Application: TOYOTA: HILUX 3.0 16V D' 05 R78-M55 12V (R)

Observação / Note: CAIXA COM 10 PEÇAS / BOX WITH 10 PIECES. (BOSCH)

I

BC1-0094-00 STD A = Ø 10,015

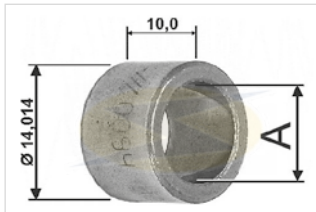

Aplicação / Application: TOYOTA: HILUX 3.0 16V D' 05 R78-M55 12V (R)

Observação / Note: CAIXA COM 10 PEÇAS / BOX WITH 10 PIECES. (BOSCH)

LC

BC1-0097-00 STD A = Ø 12,010

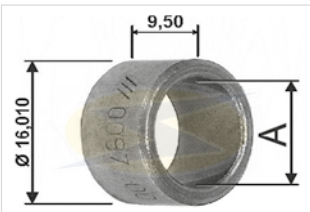

Aplicação / Application: FIAT: STILO, PALIO, SIENA, DOBLO, STRADA, CHEVROLET-GM: ASTRA, BLAZER, S-10, VECTRA, ZAFIRA, NOVO CORSA, MERIVA, MONTANA

Observação / Note: CAIXA COM 10 PEÇAS / BOX WITH 10

PIECES. (DELCOREMY PG-260D)

Legenda:

- LM:** Lado Motriz / Engine Side
- LC:** Lado Coletor / Commutator Side
- I:** Intermediária / Intermediate
- PLAN.:** Planetária / Planetary Gear

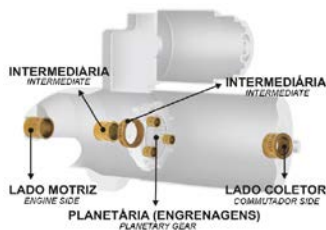

LM / LC

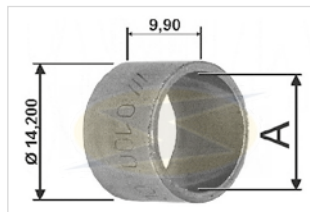

BC1-0100-00 STD A = Ø 12,075

Aplicação / Application: FORD: FIESTA, FOCUS E KA (MOTORCRAFT), MONDEO 1.8 E 2.0, RANGER 2.5 XL E XLT, PICK-UP F250, F350, F4000

Observação / Note: CAIXA COM 10 PEÇAS / BOX WITH

10 PIECES. (BOSCH EV)

LC / I

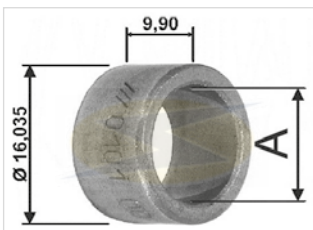

BC1-0101-00 STD A = Ø 11,930

Aplicação / Application: MITSUBISHI: L-200, FORD: ESCORT 1.8 16V C/ MOTOR ZETEC, KA 1.0 ZETEC GASOLINA, 1.3 GASOLINA - PINHÃO MAIOR

Observação / Note: CAIXA COM 10 PEÇAS / BOX WITH 10

PIECES. (MOTORCRAFT, BOSCH)

LM

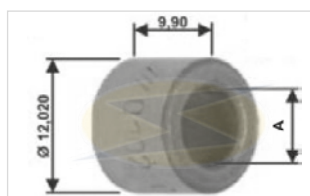

BC1-0102-00 STD A = Ø 7,040

BC1-0102-02 2K A = Ø 6,905

Aplicação / Application: FORD: ESCORT 1.8 16V, KA 1.0 ZETEC, FIESTA 1.3 ENDURA, FIAT: DUCATO 8 2.5 DIESEL

Observação / Note: CAIXA COM 10 PEÇAS / BOX WITH 10

PIECES. (DELCO)

LM

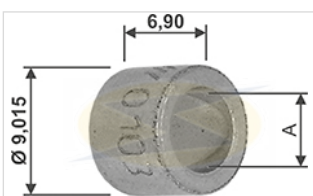

BC1-0103-00 STD A = Ø 6,020

Aplicação / Application: RENAULT: LAGUNA, NEVADA, R19 E MEGANE

Observação / Note: CAIXA COM 10 PEÇAS / BOX WITH

10 PIECES.

I

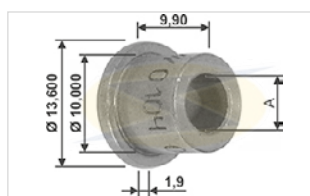

BC1-0104-00 STD A = Ø 6,025

Aplicação / Application: RENAULT: LAGUNA, NEVADA, R19 E MEGANE

Observação / Note: CAIXA COM 10 PEÇAS / BOX WITH

10 PIECES.

LM

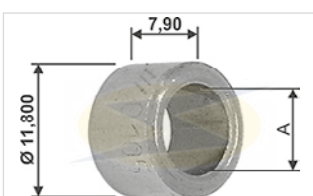

BC1-0105-00 STD A = Ø 8,020

Aplicação / Application: VW: FOX E GOLF

Observação / Note: CAIXA COM 10 PEÇAS / BOX WITH

10 PIECES.

PT

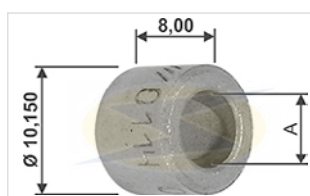

BC1-0114-00 STD A = Ø 6,105

Aplicação / Application: MOTORCRAFT, BOSCH (DW)

Observação / Note: CAIXA COM 10 PEÇAS / BOX WITH

10 PIECES.

BC1-0115-00 STD A = Ø 22,260

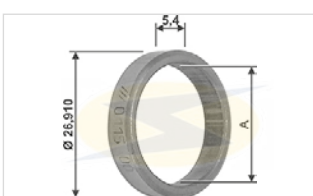

Aplicação / Application: GM: ASTRA, VECTRA, ZAFIRA, S10, BLAZER, CORSA E MERIVA, FIAT: STILO

Observação / Note: CAIXA COM 10 PEÇAS / BOX WITH

10 PIECES.

BC1-0116-00 STD A = Ø 6,025

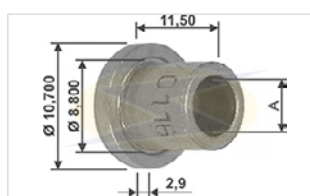

Aplicação / Application: GM: ASTRA, VECTRA, ZAFIRA, S10, BLAZER, CORSA E MERIVA, FIAT: STILO

Observação / Note: CAIXA COM 10 PEÇAS / BOX WITH

10 PIECES.

Legenda:

- LM: Lado Motriz / Engine Side
- LC: Lado Coletor / Commutador Side
- I: Intermediária / Intermediate
- PLAN.: Planetária / Planetary Gear

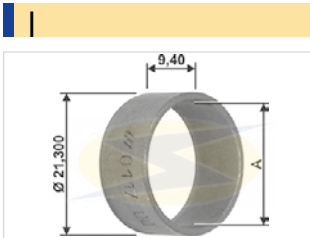
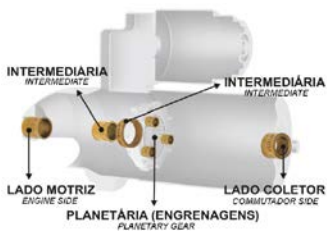

BC1-0117-00 STD A = Ø 19,115

Aplicação / Application: MOTOR MITSUBISHI: EMPL-LHADEIRAS / FORK-LIFT MITSUBISHI, HISTER E CLARK

Observação / Note: CAIXA COM 10 PEÇAS / BOX WITH 10 PIECES.

LM

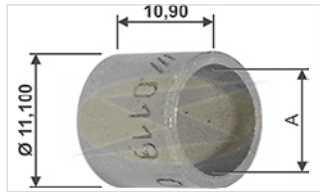

BC1-0119-00 STD A = Ø 9,025

Aplicação / Application: GM: CELTA E CORSA

Observação / Note: CAIXA COM 10 PEÇAS / BOX WITH 10 PIECES.

BC1-0121-00 STD A = Ø 10,015

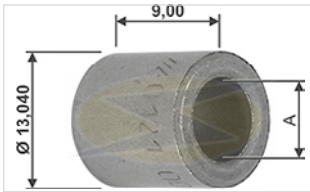

Aplicação / Application: MB: LIMPADOR MODELOS ANTIGO, MODERNO E BICUDINHO

Observação / Note: CAIXA COM 10 PEÇAS / BOX WITH 10 PIECES.

PLAN.

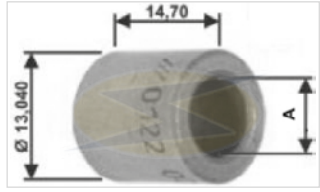

BC1-0122-00 STD A = Ø 8,020

Aplicação / Application: CATERPILLAR, CHRYSLER, CUMMINS, DODGE: RAM 2.500 CUMMINS 6CC 5.9L, FORD, FREIGHTLINER, GRADALL, INTERNATIONAL NAVISTAR, JOHN DEERE, VOLKSWAGEN

Observação / Note: CAIXA COM 10 PEÇAS / BOX WITH 10

PIECES. UNIFAP: PLANETÁRIAS: 12.100



UNIFAP.com.br

PRESTOLITE / LUCAS / INDIEL **KT-0001-00**



Aplicação / Application: VOLKSWAGEN:
C/ MOTORES / ENGINES CUMMINS 24V
5.9 E 8.3, FORD: POWER STROKE C/
MOTOR NAVISTAR V8 7.3. (PRESTOLITE,
LUCAS, INDIEL: M100R)

Composição / Composition:
1 Bucha BC1-0053
1 Bucha BC1-0056
1 Bucha BC1-0057
1 Bucha BC1-0058

WAPSA **KT-0002-00**
KT-0002-02
KT-0002-03



Aplicação / Application: VOLKSWA-
GEN: CAMINHÕES, FORD: MOTORES
PERKINS E MWM - EIXO GROSSO /
THICK SHAFT

Composição / Composition:
1 Bucha BC1-0022
1 Bucha BC1-0023

BOSCH **KT-0003-00**
KT-0003-02
KT-0003-03



Aplicação / Application: VOLKSWAGEN:
FOX 1.0 / 1.6, POLO 1.6 (2005→)

(BOSCH: DA)

Composição / Composition:
1 Bucha BC1-0003
1 Bucha BC1-0009

BOSCH / ROHER **KT-0004-00**
KT-0004-02
KT-0004-03



Aplicação / Application: AGRALE, CASE,
CBT, VOLKSWAGEN: MOTOR / ENGINE
MWM, FORD: CARGO, MASSEY FER-
GUSON, MAXION, MERCEDES-BENZ.
(BOSCH: JF)

Composição / Composition:
1 Bucha BC1-0016
1 Bucha BC1-0024
1 Bucha BC1-0025

BOSCH / DELCO **KT-0005-00**
KT-0005-02
KT-0005-03



Aplicação / Application: VOLKSWA-
GEN: FUSCA, GOL 1.3 / 1.5 / 1.6
(→12/1993), KOMBI 1.6 (ALC./GAS.)
(08/1982→12/1993), BRASÍLIA 1.3, 1.6
(10/1974→12/1981), FORD: CORCEL,
BELINA II, DEL REY (→1982)

Composição / Composition:
1 Bucha BC1-0009
1 Bucha BC1-0028

BOSCH **KT-0006-00**



Aplicação / Application: VOLKSWAGEN:
POLO 1.6 / 1.0 16V, POLO SEDAN
(2002→) (ARA, BAH), POLO 2.0, POLO
SEDAN 2.0 APÓS 2002 (BBX), VOLVO:
S80 T6, S80 2.9. **(BOSCH: DB)**

Composição / Composition:
1 Bucha BC1-0003
1 Bucha BC1-0037
1 Bucha BC1-0045
1 Bucha BC1-0055

MAGNETI MARELLI **KT-0007-00**



Aplicação / Application: FIAT: PALIO,
PALIO WEEKEND COM MOTOR 1.6 16V,
SIENA E TIPO

Composição / Composition:
1 Bucha BC1-0051
1 Bucha BC1-0052

DELCO **KT-0008-00**
KT-0008-02



Aplicação / Application: FORD: COM
MOTOR CUMMINS C61, 12 E 24V, 6CTAA
8.3L, MERCEDES-BENZ: CUMMINS,
VOLKSWAGEN: TITAN TRACTOR
(DELCO 37MT)

Composição / Composition:
2 Buchas BC1-0011
1 Bucha BC1-0033

BOSCH **KT-0009-00**



Aplicação / Application: MERCEDES-
-BENZ: SPRINTER 310D, 312D, 412D,
FORD: F-250, FIAT: DUCATO
(BOSCH: EV)

Composição / Composition:
1 Bucha BC1-0039
1 Bucha BC1-0045
1 Bucha BC1-0061
1 Bucha BC1-0062

PRESTOLITE / LUCAS / INDIEL **KT-0010-00**



Aplicação / Application: AGRALE, FORD:
F1000, F350, F4000, JOHN DEERE,
VOLKSWAGEN

Composição / Composition:
1 Bucha BC1-0053
1 Bucha BC1-0055
1 Bucha BC1-0059
1 Bucha BC1-0063

PRESTOLITE / LUCAS / INDIEL
KT-0011-00

Composição / Composition:
 1 Bucha BC1-0053
 1 Bucha BC1-0054
 1 Bucha BC1-0055
 1 Bucha BC1-0063

Aplicação / Application: FORD: RANGER,
 SILVERADO, SPRINTER

BOSCH
KT-0012-00
KT-0012-02
KT-0012-03

Composição / Composition:
 1 Bucha BC1-0009
 1 Bucha BC1-0020

Aplicação / Application: FIAT: UNO MILLE,
 FIORINO, ELBA, PRÊMIO, 147, OGGI,
 PANORAMA, PICK-UP, SPAZIO, FORD:
 CORCEL, DEL-REY, BELINA. (BOSCH:
 DM / DW / EF)

BOSCH / WAPSA
KT-0013-00
KT-0013-02
KT-0013-03

Composição / Composition:
 1 Bucha BC1-0009
 1 Bucha BC1-0018

Aplicação / Application: VOLKSWAGEN:
 SEDAN 1300, 1500, 1600 4P, KOMBI,
 KARMANN GUIA, VARIANT, BRASÍLIA,
 SP-2 (1967→), FORD: AERO WILLYS,
 RURAL, F75, MAVERICK 6CC

DELCO
KT-0014-00
KT-0014-02
KT-0014-03

Composição / Composition:
 1 Bucha BC1-0006
 1 Bucha BC1-0008

Aplicação / Application: CHEVROLET-GM:
 OPALA, CARAVAN 4 E 6CC, C10 6CC

DELCO
KT-0015-00

Composição / Composition:
 1 Bucha BC1-0011
 1 Bucha BC1-0012
 1 Bucha BC1-0013

Aplicação / Application: FORD: MOTOR
 / ENGINE CUMMINS SC 61, 12 E 24V,
 MERCEDES-BENZ: MOTORES SÉRIE
 BR-400 12 E 24V, VOLKSWAGEN:
 MOTOR / ENGINE CUMMINS SÉRIE C 12 E
 24V. (DELCO REMY: 42MT)

MOTORCRAFT
KT-0016-00



Composição / Composition:
 1 Bucha BC1-0038
 1 Bucha BC1-0045
 2 Buchas BC1-0072

Aplicação / Application: FORD: ESCORT
 1.8 16V ZETEC, FIESTA, FOCUS, KA,
 MONDEO, RANGER

BOSCH
KT-0017-00

Composição / Composition:
 1 Bucha BC1-0019
 1 Bucha BC1-0037
 1 Bucha BC1-0045
 1 Bucha BC1-0055

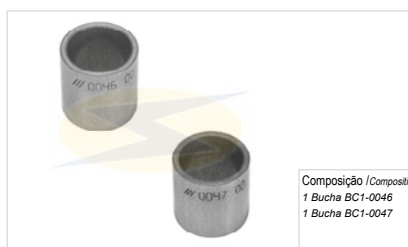
Aplicação / Application: CHEVROLET-
 -GM: OMEGA 2.2, 3.0, VECTRA, CORSA
 MERCEDES-BENZ: MB180D (OM616),
 FURGÃO, PICK-UP, SPRINTER, VW: GOL
 GTI. (BOSCH: DW)

LUCAS
KT-0018-00

Composição / Composition:
 1 Bucha BC1-0046
 1 Bucha BC1-0047

Aplicação / Application: FORD: F-1000,
 F-4000 MWM 4CC, D20, TRAFFIC, JOHN
 DEERE: TRATOR 6300, 6600, 7500
 (1996→)

BOSCH / DELCO / NASHVILLE
KT-0019-00
KT-0019-02
KT-0019-03

Composição / Composition:
 1 Bucha BC1-0026
 1 Bucha BC1-0027

Aplicação / Application: SCANIA: SÉRIES
 F / K / L / N / S / BN, MERCEDES-BENZ,
 FIAT, VOLVO. (BOSCH: KB, DELCO
 REMY: KB)

BOSCH
KT-0020-00
KT-0020-02
KT-0020-03

Composição / Composition:
 2 Buchas BC1-0016
 1 Bucha BC1-0017

Aplicação / Application: AGRALE,
 MERCEDES-BENZ, TOYOTA: COM
 MOTOR OM352. (BOSCH: JD)

BOSCH **KT-0021-00**

Aplicação / Application: **VOLKSWAGEN:**
 GOL GII (BOLA), SANTANA, PARATI,
 SAVEIRO

(BOSCH: DW)

Composição / Composition:
 1 Bucha BC1-0028
 1 Bucha BC1-0037
 1 Bucha BC1-0045
 1 Bucha BC1-0055

BOSCH **KT-0022-00**
KT-0022-02

Aplicação / Application: **CHEVROLET-**
-GM: OMEGA 2.2 / 3.0, CORSA 1.0 / 1.4,
 VECTRA 2.0 / 2.2 POWERTECH

Composição / Composition:
 1 Bucha BC1-0002
 1 Bucha BC1-0028

LUCAS / INDIEL **KT-0023-00**

Aplicação / Application: **CHEVROLET-GM:**
 C10 CUSTOM DELUXE / SILVERADO,
FORD: FAIRLANE MOTORES / PICK UP
 F100 6 E 8 CIL (1969/77) / FALCON /
 RANCHERO 3.0 (71/77), F350-600-700
 (DESDE 1977)

Composição / Composition:
 2 Buchas BC1-0049

BOSCH / DELCO **KT-0024-00**
KT-0024-02
KT-0024-03

Aplicação / Application: **CHEVROLET-GM:**
 CARAVAN 4CIL., CHEVETE, MARAJÓ
 (ALC. E GAS.) (→01/1981), CHEVE-
 TE 1.4, MARAJÓ 1.4 (ALC. E GAS.)
 (02/1975→07/1977). **(BOSCH: EF / DW)**

Composição / Composition:
 1 Bucha BC1-0009
 1 Bucha BC1-0019

BOSCH **KT-0025-00**
KT-0025-02

Aplicação / Application: **VOLKSWAGEN:**
 GOL CLI 1.6 (SEM AR), 1.8 (COM AR).

(BOSCH: DW)

Composição / Composition:
 1 Bucha BC1-0028
 1 Bucha BC1-0037

LUCAS **KT-0026-00**

Aplicação / Application: **FORD:** VERSAL-
 LES, PAMPA COM MOTOR AP (1992→),
VOLKSWAGEN: GOL, SANTANA,
 LOGUS, PARATI (1992→). **(LUCAS: M93)**

Composição / Composition:
 1 Bucha BC1-0040
 1 Bucha BC1-0041

GAREF **KT-0027-00**

Aplicação / Application: **FIAT:** TIPO 1.6,
 2.0, UNO, FIORINO

Composição / Composition:
 1 Bucha BC1-0007
 1 Bucha BC1-0048

LUCAS **KT-0028-00**

Aplicação / Application: **VOLKSWAGEN:**
 GOL, PARATI, SAVEIRO, **FORD:** ESCORT
 HOBBY, GUARUJÁ, FIAT: UNO 1.6

Composição / Composition:
 1 Bucha BC1-0053
 1 Bucha BC1-0054

DELCO **KT-0029-00**
KT-0029-02

Aplicação / Application: **CHEVROLET-GM:**
 OPALA, CARAVAN 4 E 6CC, C10 6CC

Composição / Composition:
 1 Bucha BC1-0006
 1 Bucha BC1-0031

LUCAS / WAPSA **KT-0030-00**
KT-0030-02

Aplicação / Application: **VOLKSWAGEN:**
 LOGUS, POINTER

Composição / Composition:
 1 Bucha BC1-0002
 1 Bucha BC1-0037

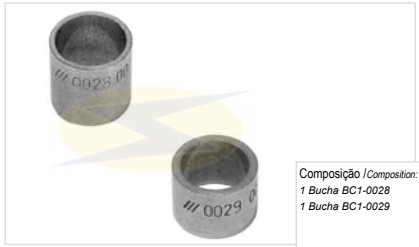
WAPSA

Composição / Composition:
1 Bucha BC1-0028
1 Bucha BC1-0029

**KT-0031-00
KT-0031-02
KT-0031-03**

Aplicação / Application: **VOLKSWA-**

GEN: PASSAT, GOL, SANTANA, FORD:

ESCORT, PAMPA

WAPSA

Composição / Composition:
1 Bucha BC1-0028
1 Bucha BC1-0029
1 Bucha BC1-0030

**KT-0032-00
KT-0032-02**

Aplicação / Application: **VOLKSWAGEN:**

KOMBI DIESEL E TODOS REFRI. A A.R,

GOL SEDAN 1300, 1500, KOMBI, BRASI-

LIA, SAVEIRO (ALC. E GAS.) (07/1982→)

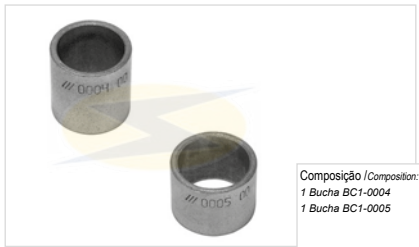
WAPSA

Composição / Composition:
1 Bucha BC1-0004
1 Bucha BC1-0005

**KT-0033-00
KT-0033-02
KT-0033-03**

Aplicação / Application: **MASSEY-FER-**

GUSON: TRATORES 55 / 65RX, MF 65R /

50 / 55X / 65X (→1971)

BOSCH

Composição / Composition:
1 Bucha BC1-0002
1 Bucha BC1-0003
1 Bucha BC1-0004
1 Bucha BC1-0005

KT-0034-00

Aplicação / Application: **FORD: FIESTA 1.0**

/ 1.3 / 1.4 / GSG / TBL / JBC / J6B / CVH14

/ PTE / ESCORT

VALEO

Composição / Composition:
1 Bucha BC1-0037
1 Bucha BC1-0039

KT-0036-00

Aplicação / Application: **FORD: ECOS-**

PORT, KA, FIESTA 1.0 / 1.0 SUPERCHAR-

GER, 1.6 ZETEC ROCAM, NOVO FIESTA

1.0 / 1.6 ZETEC ROCAM, ESCORT 1.6

ZETEC ROCAM (07/1999→). (VALEO:

D7E)

BOSCH

Composição / Composition:
1 Bucha BC1-0009
1 Bucha BC1-0039

**KT-0037-00
KT-0037-02**

Aplicação / Application: **FIAT: PALIO,**

SIENA, STRADA 1.0 / 1.4 8V FIRE 178

(03/2000). (BOSCH: DM)

BOSCH



Composição / Composition:
1 Bucha BC1-0019
1 Bucha BC1-0039
1 Bucha BC1-0045
1 Bucha BC1-0062

KT-0038-00

Aplicação / Application: **MERCEDES-**

-BENZ: MB180D (04/1994→), FURGÃO,

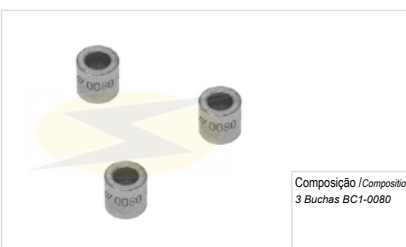
SPRINTER. (BOSCH: EV)

LUCAS / PRESTOLITE

Composição / Composition:
3 Buchas BC1-0080

KT-0039-00

Aplicação / Application: **FORD: F-250,**

F-350, PERKINS, MAXION

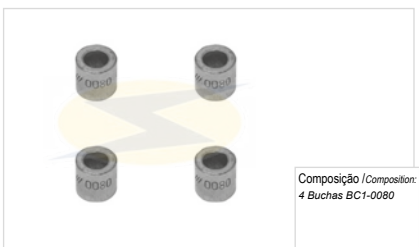
LUCAS / PRESTOLITE

Composição / Composition:
4 Buchas BC1-0080

KT-0040-00

Aplicação / Application: **FORD: F-250,**

F-350, PERKINS, MAXION

BOSCH

Composição / Composition:
1 Bucha BC1-0003
1 Retentor para bucha
BC1-0003

KT-0041-00

Aplicação / Application: **VOLKSWAGEN:**

GOL, PARATI, SANTANA, LOGUS 1.8

/ 2.0, POINTER, GOLF GTI 2.0, FORD:

FIESTA 1.4, ESCORT 1.6. (BOSCH: DA /

DB / DM / DW)

BOSCH **KT-0042-00**
KT-0042-02

Aplicação / Application: **VOLKSWAGEN:**
GOL MI (BOLA), PARATI MI, FOX 1.0
/ 1.6 (2005→) E POLO 1.6 (2005→).

(BOSCH: DA)

Composição / Composition:
1 Bucha BC1-0003
1 Bucha BC1-0009
1 Retentor para bucha BC1-0003

BOSCH **KT-0044-00**

Aplicação / Application: **TOYOTA: HILUX**
3.0 16V D' 05 R78-M55 12V.

Composição / Composition:
1 Bucha BC1-0063
1 Bucha BC1-0088
1 Bucha BC1-0093
1 Bucha BC1-0094

VALEO **KT-0046-00**

Aplicação / Application: **RENAULT: CLIO**
1.8I, LAGUNA 1.8I / 2.0I, MÉGANE 1.6I /
2.0I, R19 1.4I / 1.6 / 1.8, GM: CORSA EFI
1.0 / MPFI 1.0, PEUGEOT: 309 1.1 / 1.4, 405
1.4, CITRÔEN: AX 1.0 / 1.1 / 1.3 / 1.4, BX
1.0, XSARA 1.6, XM V6TT

Composição / Composition:
1 Bucha BC1-0029
1 Bucha BC1-0074
1 Bucha BC1-0103
1 Bucha BC-0104

MOTORCRAFT **KT-0049-00**

Aplicação / Application: **FORD: RANGER,**
FIESTA, FOCUS, KA, MONDEO

Composição / Composition:
1 Bucha BC1-0037
1 Bucha BC1-0068
1 Bucha BC1-0100
1 Rolamento 608 ZZ

BOSCH **KT-0051-00**

Aplicação / Application: **BOSCH DW**

Composição / Composition:
3 Buchas BC1-0114

MOTORCRAFT **KT-0052-00**

Aplicação / Application: **MOTORCRAFT**

Composição / Composition:
4 Buchas BC1-0114

DELCO / REMY **KT-0053-00**

Aplicação / Application: **GM: OMEGA GLS**
(1995->1998), OMEGA CD 6CC 4.1 MPFI,
SUPREMA CD 6CC 4.1 MPFI, AGILE, AS-
TRA, BLAZER, CELTA, COBALT 1.0 / 1.4
/ 1.6, CORSA / PICKUP, NOVO CORSA,
CORSA CLASSIC, MONTANA, PRISMA, S10, VECTRA - II(SOHC) 1.8 / 2.0 / 2.2 8V (03/2001->) / II(DOHC)
2.0 / 2.2 16V.

Composição / Composition:
1 Bucha BC1-0019
1 Bucha BC1-0070
1 Bucha BC1-0115
1 Bucha BC1-0116

VALEO **KT-0055-00**

Aplicação / Application: **GM: KIT PARTI-**
DA, CELTA, CORSA

Composição / Composition:
1 Bucha BC1-0037
1 Bucha BC1-0119

LUCAS INDIEL **KT-0058-00**

Aplicação / Application: **VOLKSWAGEN:**
POLO CLASSIC, POINTER, FORD:
VERSAILLES, AUDI

Composição / Composition:
1 Bucha BC1-0028
1 Bucha BC1-0038
1 Bucha BC1-0068
1 Bucha BC1-0071

VALEO **KT-0060-00**

Aplicação / Application: **CHEVROLET-GM:**
CELTA, FORD: FIESTA, KA, COURIER

Composição / Composition:
1 Bucha BC1-0037
1 Bucha BC1-0071

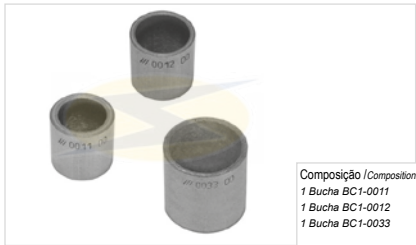
DELCO
KT-0063-00

Composição / Composition:
 1 Bucha BC1-0011
 1 Bucha BC1-0012
 1 Bucha BC1-0033

Aplicação / Application: **AGCO MASSEY-FERGUSON: TRATOR 2360 CUMMINS, CATERPILAR: COLHEITADEIRA / COMBINE MT875. (DELCO 41MT)**

BOSCH
KT-0064-00

Composição / Composition:
 1 Bucha BC1-0028
 1 Bucha BC1-0037
 1 Bucha BC1-0071
 1 Bucha BC1-0074

Aplicação / Application: **AUDI: A6, A8**

LUCAS / INDIEL
KT-0065-00



Composição / Composition:
 1 Bucha BC1-0020
 1 Bucha BC1-0038
 1 Bucha BC1-0039
 1 Bucha BC1-0045

Aplicação / Application: **VOLKSWAGEN: POINTER, POLO, ORION**

BOSCH
KT-0067-00

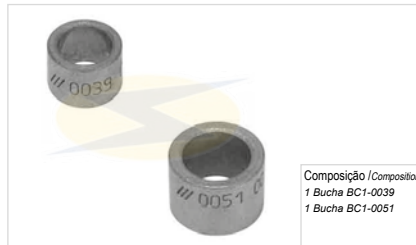

Composição / Composition:
 1 Bucha BC1-0051
 1 Bucha BC1-0063
 1 Bucha BC1-0093
 1 Bucha BC1-0101

Aplicação / Application: **MITSUBISHI: L200, TOYOTA**

VALEO
KT-0068-00

Composição / Composition:
 1 Bucha BC1-0039
 1 Bucha BC1-0051

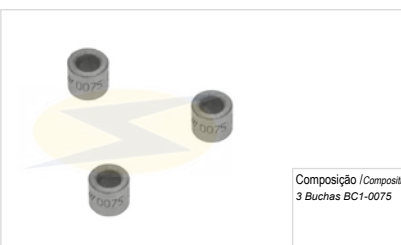
Aplicação / Application: **RENAULT (VALEO: TS10E3)**

DELCO
KT-0070-00

Composição / Composition:
 3 Buchas BC1-0075

Aplicação / Application: **CHEVROLET-GM: ASTRA, BLAZER, OMEGA, S-10, ZAFIRA**

BOSCH
KT-0071-00

Composição / Composition:
 1 Bucha BC1-0092
 1 Rolamento 6202-2RS C3
 1 Rolamento Ag 28x22x16

Aplicação / Application: **KIT PARTIDA CUMMINS JE 12/24V**

BOSCH
KT-0072-00

Composição / Composition:
 1 Bucha BC1-0091
 1 Bucha BC1-0092
 1 Rolamento 6202 2RS C3

Aplicação / Application: **KIT PARTIDA CUMMINS JE / MERCEDES-BENZ COM BUCHAS**

NIPPONDENSO
KT-0073-00

Composição / Composition:
 1 Rolamento MR-0005 (6202 2RS C3)
 2 Rolamentos MR-0006 (6005 2RS C3)
 1 Rolamento MR-0007 (6202 2RS C3)

Aplicação / Application: **CATERPILAR, CUMMINS, CASE**

MITSUBISHI
KT-0074-00

Composição / Composition:
 1 Rolamento MR-0006 (6005 2RS C3)
 1 Rolamento MR-0008 (629 Z)
 1 Rolamento MR-0009 (629 2RS C3)
 1 Rolamento MR-0010 (6002 RS)

Aplicação / Application: **MITSUBISHI: L200, L300, PAJERO, TOYOTA, FORD: RANGER**

MANDO **KT-0075-00**

Aplicação / Application: **MITSUBISHI:**
L200, EMPILHADEIRA / *FORKLIFT*, KIA:
BESTA

Composição / Composition:
1 Rolamento MR-0008 (629 Z)
1 Rolamento MR-0009 (629 2RS C3)
1 Rolamento MR-0010 (6002 RS)

NIPPONDENSO **KT-0076-00**

Aplicação / Application: KIA: BESTA 2.2

Composição / Composition:
2 Rolamentos MR-0006 (6005 2RS C3)
1 Rolamento MR-0011 (608 2RS)
1 Rolamento MR-0012 (6004 2RS C3)

BOSCH **KT-0078-00**

Aplicação / Application: **CHEVROLET-**
-GM: ESCORT, VERONA (EQ. PRIMÁRIO E EQ. COMERCIAL) COM MOTOR AP (1993→1994), **VOLKSWAGEN:** LOGUS, POINTER, POLO CLASSIC (→01/2000) (EQ. PRIMÁRIO E EQ. COMERCIAL).
(BOSCH: DM / DW)

Composição / Composition:
1 Bucha BC1-0003
1 Bucha BC1-0037

BOSCH **KT-0079-00**
KT-0079-02

Aplicação / Application: **AUDI:** A6,
CHEVROLET-GM: OMEGA GLS 2.0 / 2.2 EFI, **VOLKSWAGEN:** GOL GTS 16V
(BOSCH: DW)

Composição / Composition:
1 Bucha BC1-0019
1 Bucha BC1-0037

BOSCH **KT-0080-00**

Aplicação / Application: **FIAT:** PALIO,
PALIO WEEKEND, SIENA, STRADA 1.0 E 1.4 FIRE, **FORD:** FIESTA 1.0 / 1.3 / 1.4, **VOLKSWAGEN:** FUSCA, KOMBI 1.6 A AR.
(BOSCH: DM/EF)

Composição / Composition:
1 Bucha BC1-0009
1 Bucha BC1-0020
1 Bucha BC1-0086

WAPSA **KT-0081-00**
KT-0081-02

Aplicação / Application: **FIAT:** 147,
FIORINO, PANORAMA, **CHEVROLET-**
-GM: CARAVAN, CHEVETTE, MARAJÓ,
MONZA, OPALA

Composição / Composition:
1 Bucha BC1-0020
1 Bucha BC1-0029
1 Bucha BC1-0030

BOSCH **KT-0082-00**
KT-0082-02

Aplicação / Application: **BMW:** 316I,
318I, 320I, 323, 325I, 328, 525I, Z3, **FIAT:**
MAREA, MAREA WEEKEND, **LAND**
ROVER: DEFENDER, DISCOVERY,
RANGE ROVER

Composição / Composition:
1 Bucha BC1-0020
1 Bucha BC1-0037

BOSCH **KT-0083-00**

Aplicação / Application: **FIAT:** BRAVO,
DOBLO, PALIO, SIENA, STRADA 1.6 16V
MPI, **FORD:** ESCORT, COURIER, FIESTA
1.4 16V, **CHEVROLET-GM:** CORSA,
ASTRA, **VOLKSWAGEN:** NEW BEATLE,
GOLF GIII, GOL, SAVEIRO, PASSAT.
(BOSCH: DW)

Composição / Composition:
1 Bucha BC1-0020
1 Bucha BC1-0037
1 Bucha BC1-0086

WAPSA **KT-0084-00**
KT-0084-02
KT-0084-03

Aplicação / Application: **CBT:** TRATOR
1090 (→1971), **CLARK:** MICHIGAN 75A,
EATON: PA CARREGADEIRA 250A,
EMPILHADEIRAS / FORKLIFT, MAXION:
TRATOR MF 95X (→1971), **MULLER**

Composição / Composition:
1 Bucha BC1-0005
1 Bucha BC1-0023

BOSCH **KT-0085-00**

Aplicação / Application: **FORD:** VERSAIL-
LES 1.8 / 2.0 / 2.0i, **VOLKSWAGEN:** GOL,
VOYAGE, PARATI, SAVEIRO 1.8 (ALC. E
GAS.) **(BOSCH: EF)**

Composição / Composition:
1 Bucha BC1-0009
1 Bucha BC1-0028
1 Bucha BC1-0086

LUCAS / INDIEL
KT-0086-00



Composição / Composition:
1 Bucha BC1-0038
1 Bucha BC1-0040
1 Bucha BC1-0045

Aplicação / Application: FORD: ESCORT
1.8 ZETEC, FOCUS, MONDEO, RANGER,
CHEVROLET-GM: CORSA POWERTECH
1.4 E 1.6, VOLKSWAGEN: GOLF 1.8 GAS.
(LUCAS INDIEL: M74R)

PRESTOLITE / DELPHI / LUCAS / INDIEL
KT-0088-00

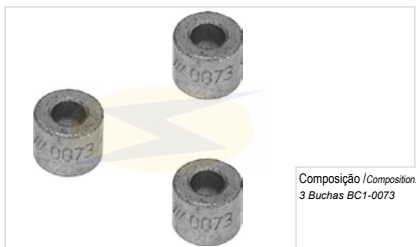

Composição / Composition:
3 Buchas BC1-0122

Aplicação / Application: FORD: CARGO,
VOLKSWAGEN: ONIBUS MWM 4 E 6 CIL.
(PRESTOLITE: M100R)

BOSCH
KT-0089-00

Composição / Composition:
3 Buchas BC1-0073

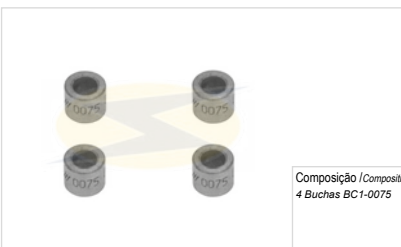
Aplicação / Application: KIT BUCHAS
PLANETÁRIA (SUB-ROLETE ENGRENHA-
GENS) MERCEDES-BENZ
(BOSCH - DW)

BOSCH
KT-0090-00

Composição / Composition:
4 Buchas BC1-0075

Aplicação / Application: FIAT: DUCATO,
FORD: F-250 4 E 6CIL. (BOSCH: EV)

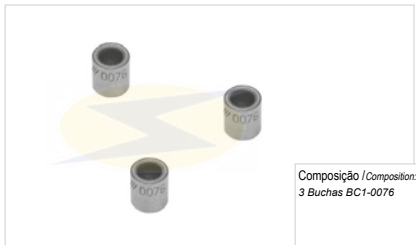
PRESTOLITE / DELPHI / LUCAS / INDIEL
KT-0091-00

Composição / Composition:
3 Buchas BC1-0076

Aplicação / Application: FORD: BLAZER,
PICK-UP F-100, F-150, F-1000, IVECO,
JOHN DEERE. (PRESTOLITE: M93R)

BOSCH
KT-0092-00

Composição / Composition:
3 Bucha BC1-0082

Aplicação / Application: KIT BUCHAS
PLANETÁRIA (SUB-ROLETE ENGRENHA-
GENS), MERCEDES-BENZ: SPRINTER
310D, 312D, 412D (Om014 LA E OM014 A)
BOSCH - EV

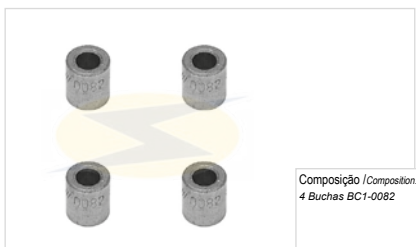
BOSCH
KT-0093-00

Composição / Composition:
4 Buchas BC1-0082

Aplicação / Application: KIT BUCHAS
PLANETÁRIA (SUB-ROLETE ENGRENHA-
GENS), MB 180D (OM616)
(BOSCH - EV)

BOSCH
KT-0095-00

Composição / Composition:
1 Bucha BC1-0039
1 Bucha BC1-0045
1 Bucha BC1-0048
1 Bucha BC1-0051

Aplicação / Application: TOYOTA: HILUX
2006

PRESTOLITE
KT-0096-00

Composição / Composition:
1 Bucha BC1-0053
1 Bucha BC1-0059
1 Bucha BC1-0063
1 Bucha BC1-0093

Aplicação / Application: FORD: CARGO

BOSCH
KT-0098-00

Composição / Composition:
1 Bucha BC1-0009
1 Bucha BC1-0054

Aplicação / Application: VOLKSWAGEN:
PASSAT, GOL, VOYAGE, PARATI

WAPSA

KT-0099-00



Composição / Composition:
1 Bucha BC1-0041
1 Bucha BC1-0054

Aplicação / Application: **FORD:**

VERSAILLES, APOLO, PAMPA



BUCHAS SINTERIZADAS *SINTERED BUSHES*



Vendas Internacionais
International Sales
055 (47) 3332-8383
unifap@unifap.com.br

Gerência Comercial Reposição Brasil:
Sérgio Ferreira - sergio@unifap.com.br
(47) 7811-4940 / 55*922*684
(47) 9642-3232 / (11) 9 8615-2409

:: Representantes Brasil ::

Estado / State	Contato / Contact	Telefone / Phone	Email
Acre	Valdez Representações (Valdez)	(69) 3441-3878	contato@valdez.com.br
Alagoas	Servo Representações (Zezinho)	(75) 3623-0627	servo@servo.com.br
Amazonas	G.F. Representações (Gleison)	(92) 3238-7609	gfrep.am@gmail.com
Amapá	G.F. Representações (Gleison)	(92) 3238-7609	gfrep.am@gmail.com
Bahia	Servo Representações (Zezinho)	(75) 3623-0627	servo@servo.com.br
Ceará	Norpres Representações (Helber)	(85) 3248-2625	norpres1@gmail.com
Distrito Federal	Fedato Representações (Carlos)	(62) 3033-2005	fedato@terra.com.br
Espírito Santo	Esthavic Representações (Edson)	(27) 3033-3230	esthavic@esthavic.com.br
Goiás	Fedato Representações (Carlos)	(62) 3095-2005	fedato@terra.com.br
Maranhão	Saragão Representações (Zeca)	(91) 3235-0680	sumapa@uol.com.br
Minas Gerais	Pro-Mar Representações (Salazar)	(31) 3332-9411	promarbh@promarbh.com.br
Mato Grosso do Sul	Enoch Representações (Reni)	(67) 3382-6788	enochcom@terra.com.br
Mato Grosso	Enoch Representações (Reni)	(67) 3382-6788	enochcom@terra.com.br
Pará	Saragão Representações (Zeca)	(91) 3235-0680	sumapa@uol.com.br
Paraíba	Mano Representações (Mano)	(81) 3075-4982	vendas@manorepresentacoes.com.br
Pernambuco	Mano Representações (Mano)	(81) 3075-4982	vendas@manorepresentacoes.com.br
Piauí	Norpres Representações (Helber)	(85) 3248-2625	norpres1@gmail.com
Paraná	HSW Representações (Hamilton)	(44) 3025-5990	hsw@hsw.ind.br
Rio de Janeiro	Ricser Representações (Ricardo)	(21) 2215-2520	rioconsultor@terra.com.br
Rio Grande do Norte	Mano Representações (Mano)	(81) 3075-4982	vendas@manorepresentacoes.com.br
Rondônia	Valdez Representações (Valdez)	(69) 3441-3878	contato@valdez.com.br
Roraima	G.F. Representações (Gleison)	(92) 3238-7609	gfrep.am@gmail.com
Rio Grande do Sul	ARDM Asses. em Vendas (Madeira)	(51) 3232-4212	adelinomadeira@terra.com.br
Santa Catarina	HSW Representações (Hamilton)	(44) 3025-5990	hsw@hsw.ind.br
Sergipe	Servo Representações (Zezinho)	(75) 3623-0627	servo@servo.com.br
São Paulo - Grande SP	Empatia Representações (Frederico)	(11) 2358-2129	hideomassuda@uol.com.br
São Paulo - Interior	Agea Representações (Walter)	(19) 3212-1287	agea@agearepres.com.br
Tocantins	Fedato Representações (Carlos)	(62) 3095-2005	fedato@terra.com.br



Peças Automotivas | *Automotive Parts*

2016/17

UNIFAP.com.br



UNIFAP INDÚSTRIA METALÚRGICA LTDA

Rua João Barbieri, 605 - Bairro Barracão
Gaspar - SC | Brasil | CEP: 89113-334
fone / fax 55 47 3332.8383 / 8179